



Microcontrollers Debugger Manual

Revised: 22 October 2007





Freescale™ and the Freescale logo are trademarks of Freescale Semiconductor, Inc. CodeWarrior is a trademark or registered trademark of Freescale Semiconductor, Inc. in the United States and/or other countries. All other product or service names are the property of their respective owners.

Copyright © 1989–2007 by Freescale Semiconductor, Inc. All rights reserved.

Information in this document is provided solely to enable system and software implementers to use Freescale Semiconductor products. There are no express or implied copyright licenses granted hereunder to design or fabricate any integrated circuits or integrated circuits based on the information in this document.

Freescale Semiconductor reserves the right to make changes without further notice to any products herein. Freescale Semiconductor makes no warranty, representation or guarantee regarding the suitability of its products for any particular purpose, nor does Freescale Semiconductor assume any liability arising out of the application or use of any product or circuit, and specifically disclaims any and all liability, including without limitation consequential or incidental damages. “Typical” parameters that may be provided in Freescale Semiconductor data sheets and/or specifications can and do vary in different applications and actual performance may vary over time. All operating parameters, including “Typicals”, must be validated for each customer application by customer's technical experts. Freescale Semiconductor does not convey any license under its patent rights nor the rights of others. Freescale Semiconductor products are not designed, intended, or authorized for use as components in systems intended for surgical implant into the body, or other applications intended to support or sustain life, or for any other application in which the failure of the Freescale Semiconductor product could create a situation where personal injury or death may occur. Should Buyer purchase or use Freescale Semiconductor products for any such unintended or unauthorized application, Buyer shall indemnify and hold Freescale Semiconductor and its officers, employees, subsidiaries, affiliates, and distributors harmless against all claims, costs, damages, and expenses, and reasonable attorney fees arising out of, directly or indirectly, any claim of personal injury or death associated with such unintended or unauthorized use, even if such claim alleges that Freescale Semiconductor was negligent regarding the design or manufacture of the part.

How to Contact Us

Corporate Headquarters	Freescale Semiconductor, Inc. 7700 West Parmer Lane Austin, TX 78729 U.S.A.
World Wide Web	http://www.freescale.com/codewarrior
Technical Support	http://www.freescale.com/support



Table of Contents

Introduction

Manual Contents	21
---------------------------	----

Book I - Debugger Engine

Book I Contents	23
---------------------------	----

1 Introduction 25

Freescale Debugger	25
Debugger Application	25
Debugger Features	26
Demo Version Limitations on Components	26

2 Debugger Interface 27

Introduction	27
Application Programs	27
Starting the Debugger	28
Starting from within the IDE	28
Debugger Command Line Start	29
Debugger Main Window	32
Debugger Main Window Toolbar	33
Debugger Main Window Status Bar	33
Main Window Menu Bar	33
Component Menu	47
Window Menu	50
Help Menu	51
Component Associated Menus	52
Component Main Menu	52

Table of Contents

Component Windows Object Info Bar	53
Component Context Menu	53
Highlights of the User Interface	54
Activating Services with Drag and Drop	54
To Drag and Drop an Object	55
Drag and Drop Combinations	55
3 Debugger Components	61
Component Introduction	61
CPU Components	61
Window Components	61
Connection Components	62
Loading Component Windows	62
General Debugger Components	64
Assembly Component	64
Command Line Component	69
Coverage Component	73
DA-C Link Component	76
Data Component	79
Memory Component	90
Module Component	102
Procedure Component	104
Profiler Component	106
Recorder Component	109
Register Component	111
Source Component	115
Terminal Component	125
Trace Component	130
Visualization Utilities	133
Inspector Component	133
Visualization Tool Component	141
4 Control Points	157
Introduction	157
Breakpoints	158

Breakpoints Tab	160
Multiple Selections in List Box	161
Checking Expressions	161
Saving Breakpoints	162
Setting Breakpoints	164
Positions Where a Breakpoint Is Definable	164
Temporary Breakpoints	165
Permanent Breakpoints	165
Counting Breakpoints	166
Conditional Breakpoints	167
Deleting Breakpoints	168
Associate a Command with a Breakpoint	169
Watchpoints	170
Watchpoints Tab	172
Multiple Selections	173
Checking Syntax	173
Setting Watchpoints	174
Setting a Read Watchpoint	174
Setting a Write Watchpoint	175
Defining a Read/Write Watchpoint	175
Defining a Counting Watchpoint	176
Defining a Conditional Watchpoint	177
Deleting a Watchpoint	178
Associate a Command with a Watchpoint	178
Markpoints	179
Markpoints Tab	181
Setting Markpoints	182
Setting a Source Markpoint	182
Setting a Data Markpoint	183
Setting a Memory Markpoint	183
Deleting a Markpoint	184
Halting on a Control Point	184

5 Real Time Kernel Awareness 185

Introduction	185
------------------------	-----

Table of Contents

Inspecting Task State	186
Task Description Language	186
Application Example	188
Inspecting Kernel Data Structures	189
OSEK Kernel Awareness	190
OSEK Run Time Interface	191
ORTI File and Filename	191
OSEK RTK Inspector Component	193
6 How To...	199
How To Configure the Debugger	199
For Use from Desktop	199
Starting Debugger from CodeWarrior IDE	200
Automating Debugger Startup	201
How To Load an Application	202
How to Start an Application	202
How to Stop an Application	203
How to Step in the Application	203
On Source Level	203
Step Over a Function Call (Flat Step)	204
Step on Assembly Level	205
How to Work on Variables	205
Display Local Variable from a Function	205
Display Global Variable from a Module	206
Change Format for Variable Value Display	207
Modify a Variable Value	208
Get the Address Where a Variable is Allocated	208
Inspect Memory Starting at a Variable Location Address	209
Load an Address Register with the Address of a Variable	209
How to Work on the Register	209
Change Format of Register Display	209
Modify a Register Content	210
Start Memory Dump at Address Where Register is Pointing	211
Modify Content of Memory Address	212
How to Consult Assembler Instructions Generated by a Source Statement	212

How to View Code	213
How to Communicate with the Application	214
7 CodeWarrior IDE Integration	215
Debugger Configuration	215
8 Debugger DDE Capabilities	217
Introduction	217
DDE Implementation	217
9 Synchronized Debugging Through DA-C IDE	219
Configuring DA-C IDE for Freescale Tool Kit.	219
Create New Project	220
Configuring The Tools	226
Debugger Interface	230
DA-C IDE and Debugger Communication	230
Synchronized Debugging	233
Troubleshooting	234

Book II - HC08 Debug Connections

Book II Contents	237
10 Microcontroller Debugging First Steps	239
Technical Considerations	239
Full Chip Simulation Considerations	239
HC08 Serial Monitor Considerations	240
ICS MON08 Interface Connection	240
P&E Multilink/Cyclone Pro Considerations	240
ICS P&E Multilink/Cyclone Pro Considerations	240
SofTec HC08 Considerations	240
Debugging First Steps Using the Wizard	241
Switching Connections	246

Table of Contents

Loading the Full Chip Simulation Connection	246
Loading the P&E Multilink/Cyclone Pro Connection.	248
Loading the HC(S)08 or RS08 Open Source BDM Connection	251
11 HC08 Full Chip Simulation	253
Configuration Procedure	253
Select Device Option	255
Full Chip Simulation Module Commands.	255
Peripheral Modules Options	257
ADC Module Option	258
Clock Generation Module Option	260
High-Resolution PWM Module.	262
Input/Output (I/O) Ports Module.	265
External Interrupt Module	268
Keyboard Interrupt Module	269
Multi-Master Inter-Integrated Circuit Module	272
FCSMSCAN Controller Module	276
FCS Programmable Timer Interrupt Module.	291
FCS Serial Communications Interface Module.	292
FCS Slave LIN Interface Controller Module.	296
FCS Serial Peripheral Interface Module	300
FCSTimer Interface Module	304
FCS Universal Serial Bus (USB) Module	309
12 MON08 Interface Connection	333
Connection Procedure	333
Advanced Settings Tab	335
Target MCU Security Bytes.	338
Active Mode Connection Menu Options	342
Device Class Description	346
13 ICS MON08 Interface Connection	349
ICS Mode	349
Connection Procedure	350
Advanced Settings Tab	352

Cycle Power Radio Button	354
Target MCU Security Bytes	355
STATUS Area	355
Active Mode Connection Menu Options.	358
Device Class Description	361
14 HC08 P&E Multilink/Cyclone Pro Connection	365
Connection Procedure.	365
Advanced Settings Tab	368
Target MCU Security Bytes	371
STATUS Area	372
Connection (MultilinkCyclonePro) Menu	374
Active Mode Menu Options	375
Debugging Limitations	379
Debugging Tips	379
Device Class Description	380
Class 5 Device.	380
Class 7 Device.	380
Class 8 Device.	380
15 HC08 ICS P&E Multilink/Cyclone Pro Connections	381
Connection Procedure.	382
Advanced Settings Tab	384
Target MCU Security Bytes	387
STATUS Area	387
Active Mode Menu Options	390
Device Class Description	393
Class 5 Device.	393
Class 7 Device.	393
Class 8 Device.	394
16 SofTec HC08 Connection	395
SofTec HC08 Technical Considerations.	395
CodeWarrior IDE and SofTec HC08 Connection.	395
Using the Stationery Wizard.	396

Table of Contents

From Within an Existing Project	397
inDart-HC08 Menu Options	398
MCU Configuration Dialog Box	399
Communication Settings Dialog Box	399
About Dialog Box	400
17 HC08 FSICEBASE Emulator	401
FSICEBASE Overview	401
System Requirements	402
System Features	402
System Components	403
Setting Up the FSICEBASE System	405
Setting Up the Hardware	405
Establishing Communication	407
Communication Through Ethernet Port	407
Communication Through USB Port	408
Setting Up the System	409
Specifying A Connection	409
Specifying Communication Information	410
Assigning an IP Address to FSICEBASE	412
Specifying a Memory Map	414
Specifying the Clock Speed	417
Emulation System Reset	419
Setting Up Logic Cables and Connectors	419
Bus State Analyzer (BSA)	421
Using BSA	421

Book III - HCS08 Debug Connections

Book III Contents	429
-----------------------------	-----

18 HCS08 Full Chip Simulation	431
Configuration Procedure	431

Connection (HCS08FCS) Menu	432
Peripheral Modules Commands	435
ADC Module	436
Clock Generation Module	438
Inter-Integrated Circuit Module	440
Input/Output (I/O) Ports Module	444
External Interrupt (IRQ) Module	447
Keyboard Interrupt Module	450
Modulo Timer Interrupt Module	452
Serial Communications Interface Module	453
Serial Peripheral Interface Module	457
Timer Interface Module	461
19 HCS08 P&E Multilink/Cyclone Pro Connection	467
Connection Procedure	467
MultilinkCyclonePro Menu Description	470
Active Mode Menu Options	471
20 HCS08 Open Source BDM Connection	477
HCS08 Open Source BDM Technical Considerations	477
CodeWarrior IDE and HCS08 Open Source BDM Connection	477
First Steps Using the Stationery Wizard	478
First Steps From Within an Existing Project	479
HCS08 Open Source BDM Menu Options	480
HCS08 Open Source BDM Setup Dialog Box	482
Select Derivative Dialog Box	483
Information Required to Unsecure the Device	484
Show Status Dialog Box	485
21 HCS08 Serial Monitor Connection	487
Serial Monitor Technical Considerations	487
CodeWarrior IDE and Serial Monitor Connection	487
First Steps Using the Stationery Wizard	488
First Steps from Within an Existing Project	489
MONITOR-HCS08 Menu Options	492

Table of Contents

Monitor Setup Window	493
Derivative Selection Dialog Box	495
22 SofTec HCS08 Connection	497
SofTec HCS08 Technical Considerations	497
CodeWarrior IDE and SofTec HCS08 Connection	497
First Steps Using the Stationery Wizard	498
First Steps from Within an Existing Project	499
SofTec HCS08 Menu Options	500
MCU Configuration Dialog Box	501
Communication Settings Dialog Box	501
About Dialog Box	502
23 HCS08 On-Chip DBG Module	503
Reference Document	503
DBG Features	503
Specific Connection Menu Options	504
Context Menu Entries in Source, Data, Assembly and Memory Windows	505
Source and Assembly Windows	505
Trigger Stored as Markpoints	508
Data and Memory Windows	509
Expert Triggers	512
Trigger Settings	514
Trigger Module Usage	515
DBG Support Status Bar Item	515
Trigger Module Settings Window	516
DBG Module Mode Setup	517
Automatic Mode (Default)	517
Expert Mode	518
Expert Mode Tab	519
Profiling and Coverage Mode	519
Disabled Mode	520
Memory Access Triggers	521
Instruction Triggers	523
Capture Triggers	526

DBG Module Options	527
Trigger Editing	529
Trigger Module Settings Window - Display Information	530
General Settings Tab	531
Trace Component Window	532
Instructions Display	533
Graphical Display	534
Textual Display	534
Column Display and Moving	535
Goto Frame	536
Clearing Frames	536
Limitations	538
HCS08 DBG V3 New Features	538
MMU and Extended Address Space	538
LOOP1 mode	538
Ability to record until Reset and from Reset	539
Expert Triggers tab extended	543

Book IV - RS08 Debug Connections

Book IV Contents	545
24 RS08 Full Chip Simulation	547
Configuration Procedure	547
Connection (RS08FCS) Menu	548
Peripheral Modules Commands	552
25 RS08 P&E Multilink/Cyclone Pro Connection	553
Connection Procedure	553
MultilinkCyclonePro Menu Description	555
Active Mode Menu Options	556

Table of Contents

26 RS08 Open Source BDM Connection	561
RS08 Open Source BDM Technical Considerations	561
CodeWarrior IDE and RS08 Open Source BDM Connection	561
First Steps Using the Stationery Wizard	562
First Steps From Within an Existing Project	563
RS08 Open Source BDM Menu Options	564
RS08 Open Source BDM Setup Dialog Box	565
Select Derivative Dialog Box	566
Show Status Dialog Box	566
27 SofTec RS08 Connection	567
SofTec RS08 Technical Considerations	567
CodeWarrior IDE and SofTec RS08 Connection	567
First Steps Using the Stationery Wizard	568
First Steps From Within an Existing Project	570
SofTec RS08 Menu Options	571
MCU Configuration Dialog Box	572
Communication Settings Dialog Box	572
About Dialog Box	573

Book V - ColdFire® V1.0 Debug Connections

Book V Contents	575
---------------------------	-----

28 ColdFire V1 Full Chip Simulation Connection	577
Full Chip Simulation Menu	577
Memory Configuration	580
Clock Frequency Setup	586
Bus Trace	587
Full Chip Simulation Warnings	588
FCS and Silicon On-Chip Peripherals Simulation	592

FCS Visualization Utilities	593
Analog Meter Component	594
IO_LED Component	595
LED Component	597
Phone Component	598
ADC/DAC Component	600
Conversion Parameters Dialog Box	603
IT_Keyboard Component	605
Interruption Keyboard Setup	607
LCD Component	608
Monitor Component	614
Push Buttons Component	617
Programmable IO_Ports Component	619
7-Segments Display Component	621
Stimulation Component	624
Terminal Component	631
True Time I/O Stimulation	638
Stimulation Program Examples	638
Stimulation Input File Syntax	645
Electrical Signal Generators and Signals Application to Device Pins	647
Signal IO Component	647
Signal Description File EBNF	647
Base Signal Files Provided	652
Virtual Wire Connections with the Pinconn IO Component	652
Command Set to Apply Signal on ATD Pin	654
FCS Tutorials	654
Guess the Number	654
PWM Sample	663
29 ColdFire P&E Multilink/Cyclone Pro Connection	669
P&E Multilink/Cyclone Pro Technical Considerations	669
CodeWarrior IDE and P&E Multilink/Cyclone Pro Connection	669
First Steps Using the Stationery Wizard	670
First Steps From Within an Existing Project	671
P&E Multilink/Cyclone Pro Menu Options	673

Table of Contents

P&E Multilink/Cyclone Pro Setup Dialog Box674
Connection Manager Dialog Box675
Set Derivative Dialog Box676
30 SofTec ColdFire Connection	677
SofTec ColdFire Technical Considerations677
CodeWarrior IDE and SofTec ColdFire Connection677
First Steps Using the Stationery Wizard678
First Steps From Within an Existing Project679
SofTec ColdFire Menu Options681
SofTec Coldfire Setup Dialog Box682
Target Connection Dialog Box683
Communication Settings Dialog Box684
Set Derivative Dialog Box685
About Dialog Box686
31 ColdFire On-Chip DBG Module	687
DBG Features687
Context Menu Entries in Source, Data, Assembly and Memory Windows688
Trigger Module Settings Window689
Trigger Module Usage/DBG Module Setup689
General Settings695

Book VI - Connection Common Features

Book VI Contents697
----------------------------	------

32 Flash Programming	699
Non-Volatile Memory Control Utility Introduction699
Automated Application Programming699
Setup700

Advanced Options: Erase Prevention	701
NVMC Graphical User Interface	702
Modules and Module States	702
NVMC Dialog Box	703
Flash Module Handling	705
MCU Speed Information	706
Configuration: FPP File Loading	706
Loading an Application in Flash	708
Hardware Considerations	709
HCS08 CPU devices	709
HCS08 CPU devices with banked/paged EEPROM	709
ColdFire CPU devices	709
NVMC Commands	710
33 Debugging Memory Map	715
Introduction	715
The DMM GUI	715
Edition dialog and memory range edition	717
Remarks	720
CPU Core Types and Priorities	721
DMM Commands	722
Debugging Memory Map Manager command set	722

Book VII - Commands

Book VII Contents	729
34 Debugger Engine Commands	731
Commands Overview	731
Available Command Lists	732
Command Syntax Terms	740
Debugger Commands	742

Book VIII - Environment Variables

Book VIII Contents839

35 Debugger Engine Environment Variables **841**

Debugger Environment842

 The Current Directory842

 Global Initialization File (MCUTOOLS.INI - PC Only)843

Local Configuration File (usually project.ini).844

 Default Layout Configuration (PROJECT.INI).845

 Environment Variable Paths.848

Environment Variables850

Search Order for Source Files857

 In the Debugger for C Source Files (*.c, *.cpp)857

 In the Debugger for Assembly Source Files (*.dbg).857

 In the Debugger for Object Files (HILOADER)858

Debugger Files858

36 Connection-Specific Environment Variables **861**

Connection-Specific Environment Variables861

Book IX - Debugger Legacy

Book IX Contents863

37 Legacy PEDebug Target Interface **865**

New P&E Connections for HC(S)08.865

“Revert to Full Chip Simulator” Feature Removed865

Connection Selection or Change Always Available within IDE.866

Automatic Upgrade Path for Projects Previously Created866



38 Legacy Target Interfaces Removed	867
39 HC(S)08 Full-Chip Simulator Components No Longer Supported	869
List of HC(S)08 FCS Components No Longer Supported	869
Index	871



Table of Contents

Introduction

Manual Contents

The Microcontrollers Debugger Manual consists of the following books:

Book 1: Debugger engine - defines the HC08 and HC(S)08 common and base features, their functionality, and a description of the components that are available in the debugger.

- [Introduction](#)
- [Debugger Interface](#)
- [Debugger Components](#)
- [Control Points](#)
- [Real Time Kernel Awareness](#)
- [How To...](#)
- [CodeWarrior IDE Integration](#)
- [Debugger DDE Capabilities](#)
- [Synchronized Debugging Through DA-C IDE](#)

Book 2: HC08 Debugger Connections - defines the connections available for debugging code written for HC08 CPUs.

- [Microcontroller Debugging First Steps](#)
- [HC08 Full Chip Simulation](#)
- [MON08 Interface Connection](#)
- [ICS MON08 Interface Connection](#)
- [HC08 P&E Multilink/Cyclone Pro Connection](#)
- [HC08 ICS P&E Multilink/Cyclone Pro Connections](#)
- [SofTec HC08 Connection](#)
- [HC08 FSICEBASE Emulator](#)

Book 3: HCS08 Debugger Connections - defines the connections available for debugging code written for HCS08 CPUs

- [HCS08 Full Chip Simulation](#)
- [HCS08 P&E Multilink/Cyclone Pro Connection](#)
- [HCS08 Open Source BDM Connection](#)
- [HCS08 Serial Monitor Connection](#)
- [SofTec HCS08 Connection](#)

- [HCS08 On-Chip DBG Module](#)

Book 4: RS08 Debug Connections

- [RS08 Full Chip Simulation](#)
- [RS08 P&E Multilink/Cyclone Pro Connection](#)
- [RS08 Open Source BDM Connection](#)
- [SofTec RS08 Connection](#)

Book 5: ColdFire V1.0 Debug Connections

- [ColdFire V1 Full Chip Simulation Connection](#)
- [ColdFire P&E Multilink/Cyclone Pro Connection](#)
- [SofTec ColdFire Connection](#)
- [ColdFire On-Chip DBG Module](#)

Book 6: Connection Common Features

- [Flash Programming](#)
- [Debugging Memory Map](#)

Book 7: Commands

- [Debugger Engine Commands](#)

Book 8: Environment Variables

- [Debugger Engine Environment Variables](#)
- [Connection-Specific Environment Variables](#)

Book 9: Debugger Legacy

- [Legacy PEDebug Target Interface](#)
- [Legacy Target Interfaces Removed](#)
- [HC\(S\)08 Full-Chip Simulator Components No Longer Supported](#)

NOTE The Flexis series of devices is the 8- to 32-bit connection point on the Freescale Controller Continuum, where complementary families of HCS08 and ColdFire V1 microcontrollers share a common set of peripherals and development tools to deliver migration flexibility. These devices include the MC9S08QE128, MC9S08QE64, MC9S08QE96, MCF51QE128, MCF51QE64, and MCF51QE96, which are covered in Book 3 and Book 5 respectively.

Book I - Debugger Engine

Book I Contents

Each section of the Debugger manual includes information to help you become more familiar with the Debugger, to use all its functions and help you understand how to use the environment. This book, the Debugger engine, defines the HC(S)08, RS08, and ColdFire® common and base features and their functionality, and gives a description of the components that are available in the debugger.

This book is divided into the following chapters:

- This chapter describes the manual and special features of the Debugger.
- The [Introduction](#) Chapter introduces the Debugger concept.
- The [Debugger Interface](#) Chapter provides all details about the Debugger user interface environment i.e., menus, toolbars, status bars and drag and drop facilities.
- The [Debugger Components](#) Chapter contains descriptions of each basic component and visualization utility.
- The [Control Points](#) Chapter is dedicated to the control points and associated windows.
- The [Real Time Kernel Awareness](#) Chapter contains descriptions of the Real Time concept and related applications.
- The [How To...](#) Chapter provides answers for common questions and describes how to use advanced features of the Debugger.
- The [CodeWarrior IDE Integration](#) chapter explains how to configure the Debugger for use with the CodeWarrior IDE.
- The [Debugger DDE Capabilities](#) chapter describes the debugger DDE features.
- The [Synchronized Debugging Through DA-C IDE](#) chapter explains the use of tools with the DA-C IDE from RistanCase



Introduction

This section is an introduction to the Debugger from Freescale used in 8/16 bit embedded applications.

Freescle Debugger

The Debugger is a member of the tool family for Embedded Development. It is a Multipurpose Tool that you can use for various tasks in the embedded system and industrial control world. Some typical tasks are:

- Simulation and debugging of an embedded application.
- Simulation and debugging of real-time embedded applications.
- Simulation and/or cross-debugging of an embedded application.
- Multi-Language Debugging: Assembly, C and C++
- True-Time Simulation
- User Components creation with the Peripheral Builder
- Simulation of a hardware design (e.g., board, processor, I/O chip).
- Building a target application using an object oriented approach.
- Building a host application controlling a plant using an object oriented approach.

Debugger Application

A Debugger Application contains the Debugger Engine and a set of debugger components bound to the task that the components must perform (for example a simulation and debugging session). The Debugger Engine is the heart of the system. It monitors and coordinates the tasks of the components. Each Debugger Component has its own functionality (e.g., source level debugging, profiling, I/O stimulation).

You can adapt your Debugger application to your specific needs. Integrating or removing the Debugger Components is very easy. You can add additional Debugger Components (for example, for simulation of a specific I/O peripheral chip) and integrate them with your Debugger Application.

You can also open several components of the same type.

Debugger Features

- True 32-bit application
- Powerful features for embedded debugging
- Special features for real time embedded debugging
- Powerful features for True Time Simulation
- Various and Same look Target Interfaces
- User Interface
- Versatile and intuitive drag and drop functions between components
- Folding and unfolding of objects like functions, structures, classes
- Graphical editing of user defined objects
- Visualization functions
- Smart interactions with objects
- Extensibility function
- Both Powerful Simulation & Debugger
- Show Me How Tool
- GUI (graphical user interface) version including command line
- Context sensitive help
- Configurable GUI with Tool Bar
- Smooth integration into third party tools
- Supports both Freescale and ELF/DWARF Object File Format and S-Records.

Demo Version Limitations on Components

When the Debugger is started in demo mode or with an invalid engine license, then all components that are protected with FLEXlm are in demo mode. The limitations of all components are described in their respective chapter.

Debugger Interface

This chapter describes the Debugger Graphical User Interface (GUI). Topics include:

- [Introduction](#)
- [Application Programs](#)
- [Starting the Debugger](#)
- [Debugger Main Window](#)
- [Component Associated Menus](#)
- [Highlights of the User Interface](#)

Introduction

The CodeWarrior™ IDE main window acts as a container for windows of debugger components. The main window provides a main menu bar, a tool bar, a status bar for status information, and object information bars for several components.

The Debugger main window allows you to manage the layout of the different component windows (**Window** menu of the Debugger application). Component windows are organized as follows:

- Tiled arrangement - Auto tiled, component windows are automatically resized when the main window is resized
- Component windows are overlapped
- Component windows that are currently minimized are Debugger Main window icons.

Application Programs

The CodeWarrior IDE installer places executable programs in the `prog` subdirectory of the CodeWarrior IDE installation directory. For example, installing the CodeWarrior IDE software in `C:\Program Files\Freescale`, locates all program files in the folder `C:\Program Files\Freescale\CodeWarrior for Microcontrollers V6.1\prog`.

Debugger Interface

Starting the Debugger

The following list is an overview of files that the CodeWarrior IDE uses for C/C++ debugging:

- `hiwave.exe` Debugger executable file
- `hibase.dll` Debugger main function dll
- `elfload.dll` Debugger loader dll
- `*.wnd` Debugger component
- `*.tgt` Debugger target file
- `*.cpu` Debugger CPU awareness file

Starting the Debugger

This section explains how you can start the debugger from within the CodeWarrior IDE or from a DOS command line.

Starting from within the IDE

There are two ways to start the debugger from within the IDE, from a **Project** window icon, or from the IDE Main Window menu bar.

Starting Debug from the Project Window

To start the debugger from the **Project** window, click the **Debug** icon ([Figure 2.1](#)), at the top of the Project window.

Figure 2.1 Project Window Make and Debug Icons



Starting Debug from the Main Window Menu Bar

You can also start the debugger from the main menu bar of the CodeWarrior IDE. To start the debugger from the main menu bar, select Debug from the Project menu:
(*Project > Debug.*)

Figure 2.2 Main Window Project Menu

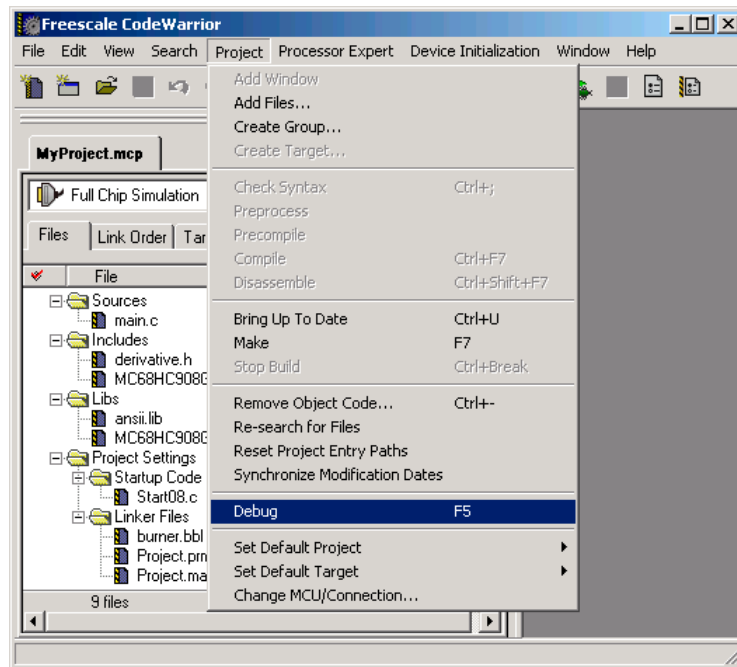

Debugger Command Line Start

You can start the debugger from a DOS command line. The command syntax is as follows:

```
HIWAVE.EXE [<AbsFileName> {-<options>}]
```

where **AbsFileName** is the name of the application to load in the debugger. Precede each option with a dash.

Command Line Options

DOS command line options are:

-T=<time>: Test mode

The debugger terminates after the specified time (in seconds). The default value is 300 seconds. For example:

```
c:\Program Files\Freescale\CodeWarrior for Microcontrollers
V6.1\prog\hiwave.exe -T=10
```

The above example instructs the debugger to terminate after 10 seconds.

-Target=<targetname>

This option sets the specified connection. For example:

```
C:\Program Files\Freescale\CodeWarrior for Microcontrollers
V6.1\prog\hiwave.exe c:\Program Files\Freescale\CodeWarrior
for Microcontrollers V6.1\demo\hc12\sim\fibonacci.abs -w -
Target=sim
```

The command in the above example starts the debugger and loads fibonacci.abs file.

-W: Wait mode

Debugger waits even when a <exeName> is specified.

-Instance=%currentTargetName

This option defines a build instance name. Once you define a build instance, the debugger uses same build instance the next time you start the debugger. For example:

```
c:\Program Files\Freescale\CodeWarrior for Microcontrollers
V6.1\prog\hiwave.exe -Instance=%currentTargetName
```

If you attempt to start the debugger again, the existing instance of the debugger is brought to the foreground.

-Prod= <fileName>

This option specifies the project directory and/or project file to be used at start-up. For example:

```
c:\Program Files\Freescale\CodeWarrior for Microcontrollers
V6.1\prog\hiwave.exe -Prod=c:\demos\project\test.pjt
```

-Nodefaults

This prevents the debugger from loading the default layout. For example:

```
c:\Program Files\Freescale\CodeWarrior for Microcontrollers
V6.1\prog\hiwave.exe -nodefaults
```

-Cmd = <Command>

This option specifies a command to be executed at start-up: -cmd = {command}. For example:

```
c:\Program Files\Freescale\CodeWarrior for Microcontrollers
V6.1\prog\hiwave.exe -cmd="open recorder"
```

-C <cmdFile>

This option specifies a command file to be executed at start-up. For example:

```
c:\Program Files\Freescale\CodeWarrior for Microcontrollers
V6.1\prog\hiwave.exe -c c:\temp\mycommandfile.txt
```

-ENVpath: "-Env" <Environment Variable> "=" <Variable Setting>

This option sets an environment variable. This environment variable may be used to overwrite system environment variables. For example:

```
c:\Program Files\Freescale\CodeWarrior for Microcontrollers
V6.1\prog\hiwave.exe -EnvOBJPATH=c:\sources\obj
```

NOTE Options are not case sensitive.

Order of Commands

Commands specified by options are executed in the following order:

1. Load (activate) the project file (see below). If the project file is not specified, `project.ini` is used by default.
2. Load <exeFile> if available and start running unless option l(W) was specified
3. Execute command file <cmdFile> if specified
4. Execute command if specified
5. Start running unless option l(W) was specified

NOTE In version 6.1 of the debugger, the loaded program starts after all command and command files are executed.

NOTE The function **Open** in the File menu interprets any file without an `.ini` extension as a command file and not a project file.

Example

C:\Program Files\Freescale\CodeWarrior for Microcontrollers
 V6.1\PROG\DEMO\TEST.ABS -w -d

Debugger Main Window

Once you start the debugger, the True Time Simulator & Real Time Debugger window opens in the right side of the IDE Main Window.

Figure 2.3 Debugger Main Window

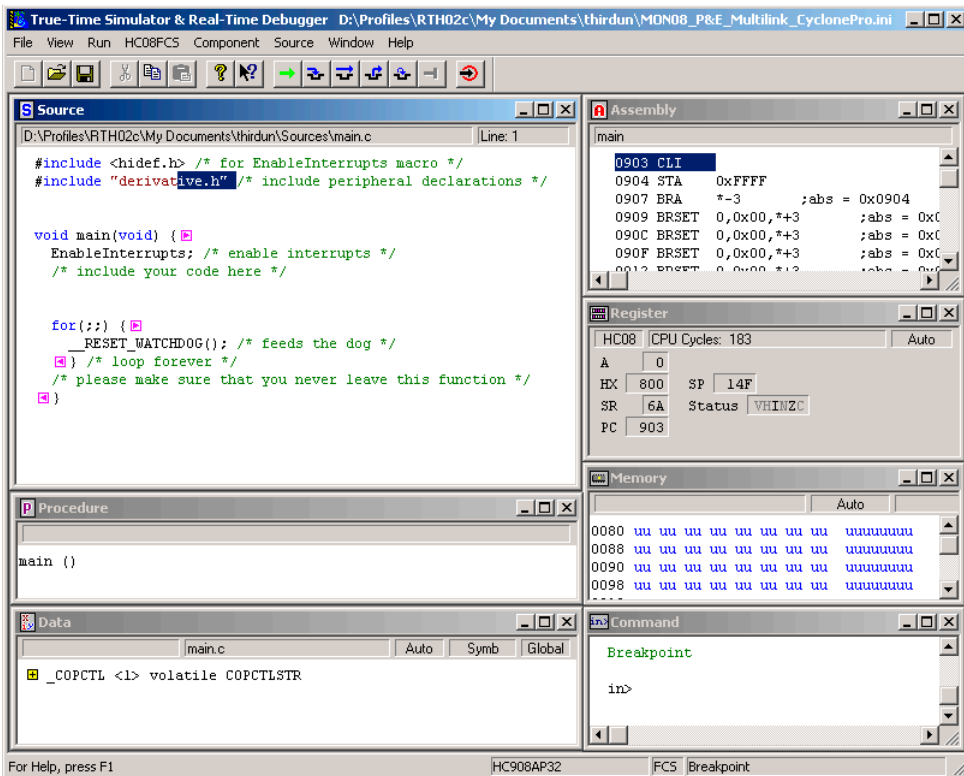

Debugger Main Window Toolbar

The Debugger Main Window toolbar is the default toolbar. Most of the Main Window menu commands have a related shortcut icon on this toolbar. [Figure 2.4](#) identifies each default icon.

Figure 2.4 Debugger Main Window Toolbar

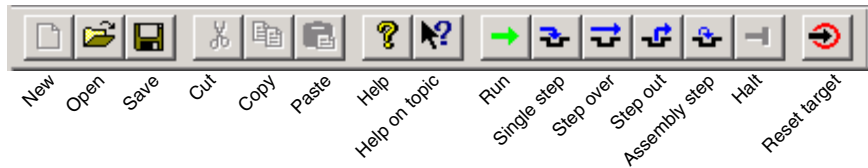

A tool tip is available when you point the mouse at an icon.

Debugger Main Window Status Bar

The status bar at the bottom of the Debugger Main Window, shown in [Figure 2.5](#) contains a context sensitive help line for connection specific information, e.g., number of CPU cycles for the **Simulator** connection and execution status.

Figure 2.5 The Debugger Status Bar



Main Window Menu Bar

The Debugger Main Window Menu Bar, shown in [Figure 2.6](#) is associated with the main function of the debugger application, connection, and selected windows.

Figure 2.6 Debugger Window Menu Bar

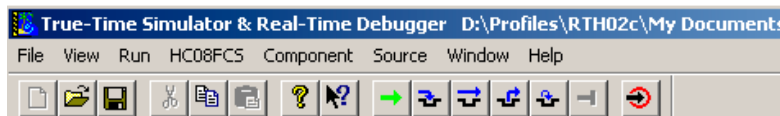

NOTE You can select menu commands by pressing the ALT key to select the menu bar then press the key corresponding to the underlined letter in the menu command.

[Table 2.1](#) describes menu entries available in the menu bar.

Table 2.1 Description of the Main Menu Toolbar Entries

Menu entry	Description
File	Contains entries to manage debugger configuration files.
View	Contains entries to configure the toolbar.
Run	Contains entries to monitor a simulation or debug session.
Connection	Contains entries to select the debugger connection. Once a connection has been selected, the name of this heading changes.
Component	Contains entries to select and configure extra component window.
Data	Contains entries to select Data component functions.
Window	Contains entries to set the component windows.
Help	A standard Windows Help menu.

File Menu

The **File** menu shown in [Figure 2.7](#) is dedicated to the debugger project.

Figure 2.7 File Menu

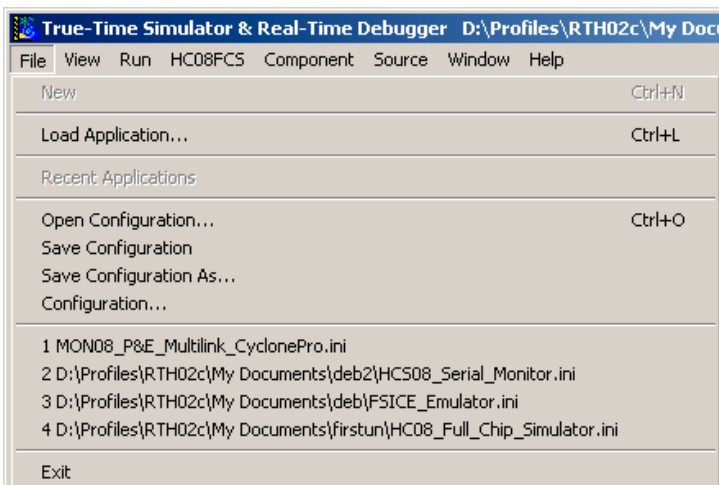

[Table 2.2](#) describes File Menu entries.

Table 2.2 File Menu Entry Description

Menu Entry	Description
New	Creates a new project.
Load Application	Loads an executable file (or debugger connection if nothing is selected).
...\restart.abs ...\await.abs ...	Recent applications list
Open Configuration	Opens the debugger project window. You can load a project file .PJT or .INI. Additionally you can load an existing .HWC file corresponding to a debugger configuration file. You can load a project .INI file containing component names, associated window positions and parameters, window parameters (fonts, background colors, etc.), connection name (e.g., Simulator) and the .ABS application file to load.
Save Configuration	Saves the project file.
Save Project As	Opens the debugger project window to save the project file under a different path and name, and format (PJT; INI...).
Configuration	Opens the Preferences window to set environment variables for current project.
1.Project.ini 2.Test.ini 3...	Recent project file list.
Exit	Quits the Debugger.

You can shortcut some of these functions by clicking toolbar icons (refer to the [Debugger Main Window Toolbar](#) section).

Configuration Window

Open the Configuration window by selecting *Configuration* from the **Files** menu. With this window (Figure 2.8) it is possible to set up environment variables for the current project. New variables are saved in the current project file when you click the **OK** button.

NOTE The corresponding menu entry (*File > Configuration*) is only enabled if a project file is loaded.

Figure 2.8 Configuration Window - Environment Tab

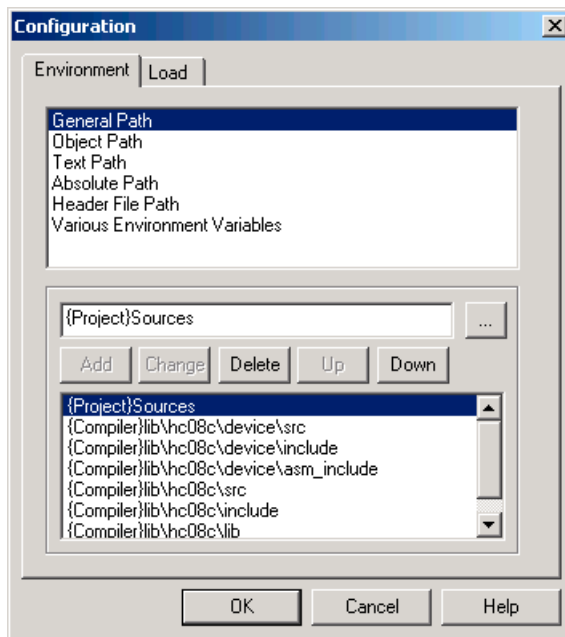

The Configuration Window - Environment tab contains the following controls:

- A list box containing all available environment variables. You can select a variable with the mouse or Up/Down buttons.
- Command Line Arguments are displayed in the text box. You can add, delete, or modify options, and specify a directory with the browse button (...).
- A second list box contains the arguments for all of the environment variables defined in the corresponding Environment section. Select a variable with the mouse or Up/Down buttons.

Command Buttons:

- **OK:** Changes are confirmed and saved in current project file.
- **Cancel:** Closes dialog box without saving changes.
- **Help:** Opens the help file.

Figure 2.9 Configuration Window - Load Tab

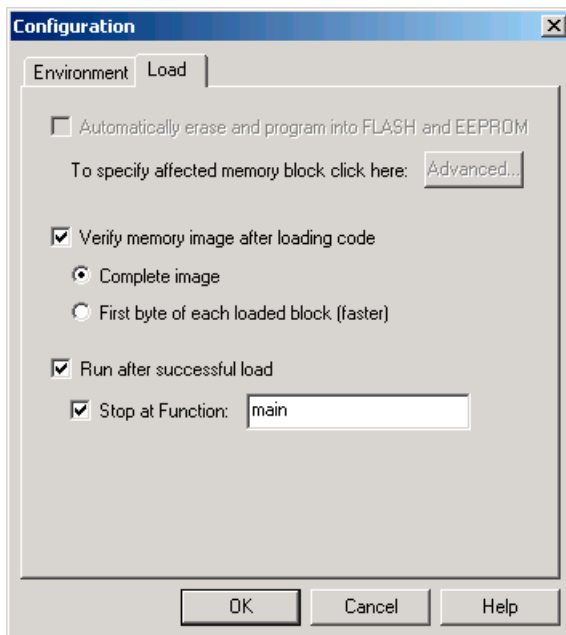

The Configuration Window - Load tab contains the following controls:

- Automatically erase and program into FLASH and EEPROM checkbox.
- A Verify memory image after loading code checkbox, with two radio buttons that let you define the memory image.
- Run after successful load checkbox.
- A Stop at Function checkbox with a textbox that lets you define the function.

Command Buttons:

- **OK:** Changes are confirmed and saved in current project file.
- **Cancel:** Closes dialog box without saving changes.
- **Help:** Opens the help file.

View Menu

In the Main Window View menu ([Figure 2.10](#)) you can choose to show or hide the toolbar, status bar, window component titles and headlines (see the [Component Windows Object Info Bar](#)). You can select smaller window borders and customize the toolbar. [Table 2.3](#) describes the View Menu entries.

Figure 2.10 View Menu

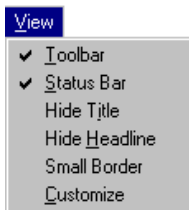

Table 2.3 View Menu Description

Menu Entry	Description
Toolbar	Check / uncheck Toolbar if you want to display or hide it.
Status Bar	Check / uncheck Status Bar if you want to display or hide it.
Hide Tile	Check / uncheck Hide Title if you want to hide or display the window title.
Hide Headline	Check / uncheck Hide Headline if you want to hide or display the headline.
Small Borders	Check / uncheck Small Border if you want to display or hide small window borders.
Customize	Opens the debugger Customize Toolbar window.

Customizing the Toolbar

When you select **Customize** from the **View** menu, the Customize Toolbar dialog box appears. You can customize the toolbar of the Debugger, adding and removing component shortcuts and action shortcuts in this dialog box. You can also insert separators to separate icons. Almost all functions in **View**, **Run** and **Window** menus are available as shortcut buttons, as shown in [Figure 2.11](#).

Figure 2.11 Customize Toolbar Dialog Box

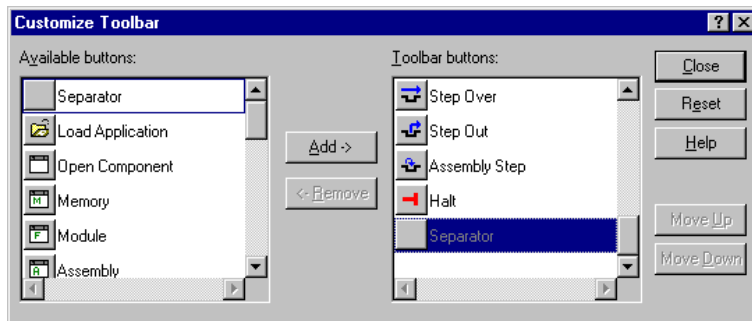

- Select the desired shortcut button in the **Available buttons** list box and click **Add** to install it in the toolbar.
- Select a button in the **Toolbar buttons** list box and click **Remove** to remove it from the toolbar.

Demo Version Limitations

The default toolbar cannot be configured.

Examples of View Menu Options

[Figure 2.12](#) shows a typical component window display.

Figure 2.12 Typical Component Window Display

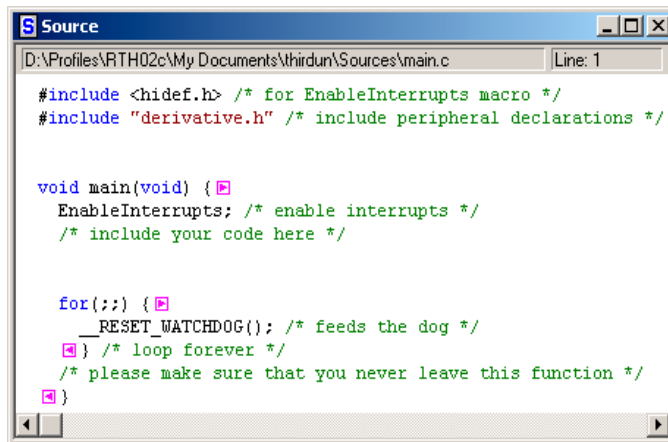

[Figure 2.13](#) shows a component window without a title and headline.

Debugger Interface

Debugger Main Window

Figure 2.13 Component Window without Title and Headline

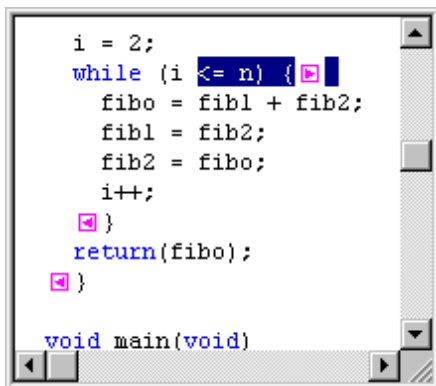

```

i = 2;
while (i <= n) {
    fibo = fib1 + fib2;
    fib1 = fib2;
    fib2 = fibo;
    i++;
}
return(fibo);
void main(void)

```

[Figure 2.14](#) shows a component window without a title and headline, and with a small border.

Figure 2.14 Component Window without Title and Headline, and with Small Border

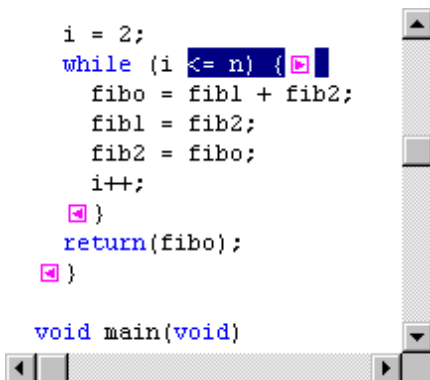

```

i = 2;
while (i <= n) {
    fibo = fib1 + fib2;
    fib1 = fib2;
    fib2 = fibo;
    i++;
}
return(fibo);
void main(void)

```

[Figure 2.15](#) shows a component window without headline and small border

Figure 2.15 Component Window without Headline and Small Border

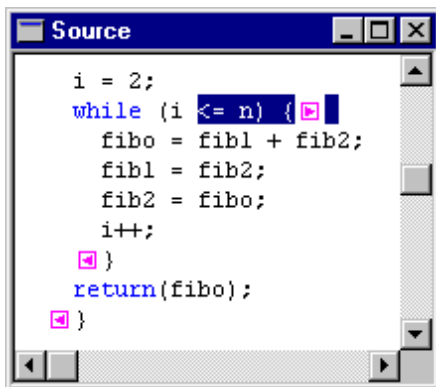

Run Menu

The Main Window Run menu, shown in [Figure 2.16](#) is associated with the debug session. You can monitor a simulation or debug session from this menu. Run menu entries are described in [Table 2.4](#).

Figure 2.16 Run Menu

Run	HC08FCS	Component	Source	Wir
Start/Continue	F5			
Restart	Ctrl+Shift+F5			
Halt	F6			
Single Step	F11			
Step Over	F10			
Step Out	Shift+F11			
Assembly Step	Ctrl+F11			
Assembly Step Over	Ctrl+F10			
Assembly Step Out	Ctrl+Shift+F11			
Control Points...				

Table 2.4 Run Menu Description

Menu entry	Description
Start/Continue	Starts or continues execution of the loaded application from the current program counter (PC) until a breakpoint or watchpoint is reached, runtime error is detected, or user stops the application by selecting <i>Run > Halt</i> . Shortcut: F5 key
Restart	Starts execution of the loaded application from its entry point. Shortcut: CTRL + Shift + F5 keys
Halt	Interrupts and halts a running application. You can examine the state of each variable in the application, set breakpoints, watchpoints, and inspect source code. Shortcut: F6 key
Single Step	If the application is halted, this command performs a single step at the source level. Execution continues until the next source reference is reached. If the current statement is a procedure call, the debugger “steps into” that procedure. The Single Step command does not treat a function call as one statement, therefore it steps into the function. Shortcut: F11 key
Step Over	Similar to the Single Step command, but does not step into called functions. A function call is treated as one statement. Shortcut: F10 key
Step Out	If the application is halted inside of a function, this command continues execution and then stops at the instruction following the current function invocation. If no function calls are present, then the Step Out command is not performed. Shortcut: Shift + F11 keys
Assembly Step	If the application is halted, this command performs a single step at the assembly level. Execution continues for one CPU instruction from the point it was halted. This command is similar to the Single Step command, but executes one machine instruction rather than a high level language statement. Shortcut: CTRL + F11 keys

Table 2.4 Run Menu Description (continued)

Menu entry	Description
Assembly Step Over	Similar to the Step Over command, but steps over subroutine call instructions. Shortcut: CTRL + F10 keys
Assembly Step Out	If the application is halted inside a function, this command continues execution and stops on the CPU instruction following the current function invocation. This command is similar to the Step Out command, but stops before the assignment of the result from the function call. Shortcut: CTRL + Shift + F11 keys
Control Points	Opens the Controlpoints Configuration Window that contains tabs that allow you to control Breakpoints, Watchpoints and Markpoints (refer to Control Points chapter).

You can provide shortcuts for some of these functions using the toolbar. Refer to the [Debugger Main Window Toolbar](#) and [Customizing the Toolbar](#) sections for details.

You can also set breakpoints and watchpoints from within the Source and Assembly component windows.

NOTE For more information about breakpoints and watchpoints, refer to the [Control Points](#) chapter.

Connection Menu

This menu entry ([Figure 2.17](#)) appears between the **Run** and **Component** menus when no connection is specified in the PROJECT.INI file and no connection has been set. The **Connection** name is replaced by an actual connection name when the connection is set. If a connection has been set, the number of menu entries is expanded, depending on the connection. To set the connection, select *Component > Set Connection*. Refer to the [Component Menu](#) section for details.

Figure 2.17 Connection Menu

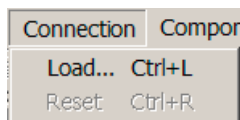

[Table 2.5](#) describes the Connection Menu entries.

Table 2.5 Connection Menu Common Option Description

Menu Entry	Description
Load	Loads a connection.
Reset	Resets the current connection.

Loading an Executable File

Use the Connection menu to load a debugger connection:

- Choose *Connection > Load*

The Load Executable File window shown in [Figure 2.18](#) appears.

Load Executable File Window

From the Load Executable File window, set the load options and choose a Simulation Execution Framework (an .ABS application file).

Figure 2.18 Load Executable File Window

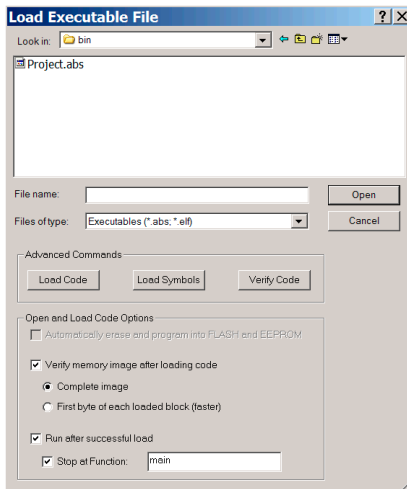

Open Button

Pressing this button loads the application code and symbols.

Load Options Buttons

These three buttons allow you to select which part of the executable file to load:

- **Load Code Button:** Loads the application code only. Loads only the application into the target system. Use this button if no debugging is needed.
- **Load Symbols Button:** Loads symbols only. Loads only debugging information. This button can be used if the code is already loaded into the target system or programmed into a non-volatile memory device (ROM/FLASH).
- **Verify Code Button:** Loader loads no data into memory. However, it reads back current data matching the same areas from the target memory and compares all data with the data from the selected file.

Open and Load Code Options Area

The checkboxes and buttons of this area of the Load Executable File window offer the following options:

- A checkbox to Automatically erase and program into FLASH and EEPROM.
- A Verify memory image after loading code checkbox, with two radio buttons that let you define the memory image.
- Run after successful load checkbox.
- A Stop at Function checkbox with a textbox that lets you define the function.

Command Buttons:

OK: Changes are confirmed and saved in current project file.

Cancel: Closes dialog box without saving changes.

Help: Opens the help file.

Connection Command File Window

From the Connection menu, choose **Command File** to open the Connection Command File window. Each tab of this window, shown in [Figure 2.19](#) corresponds to an event on which a command file can be automatically run.

See the [Startup Command File](#), [Reset Command File](#), [Preload Command File](#), and [Postload Command File](#), sections that follow. Although these command files are not generated automatically, you can install them when installing a new connection. However, the Debugger recognizes these command files and executes them. Depending on the connection used, other command files can be recognized by the Debugger. Refer to the appropriate connection chapter for command file information and properties.

Figure 2.19 Connection Command File Window

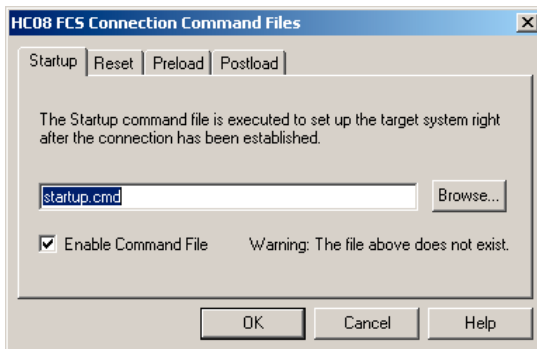

The command file in the edit box is executed when the corresponding event occurs. Click the **Browse** button to set the path and name of the command file.

The **Enable Command File** check box allows you to enable/disable a command file on an event. By default, all command files are enabled:

- The default **Startup** command file is `STARTUP.CMD`
- The default **Reset** command file is `RESET.CMD`
- The default **Preload** command file is `PRELOAD.CMD`
- The default **Postload** command file is `POSTLOAD.CMD`

NOTE **Startup** settings performed in this dialog box are stored for subsequent debugging sessions in the **[Simulator]** section of the **PROJECT** file using the variable **CMDFILE0**.

NOTE When a CPU is set, the settings performed in this dialog box are stored for subsequent debugging sessions in the **[Simulator XXX]** (where XXX is the processor) section of the **PROJECT** file using variables **CMDFILE0**, **CMDFILE1 ... CMDFILEn**.

Startup Command File

The `startup.cmd` command file is a Debugger system command file. The **Startup** command file executes after you load the connection (the target defined in the **project.ini** file or when you select *Component > Set Connection*).

You can specify the `Startup` command file full name and status (enable/disable) either with the `CMDFILE STARTUP` Command Line command or using the **Startup** property tab of the [Connection Command File Window](#).

The default settings enable the `STARTUP.CMD` file located in the current project directory as the current Startup command file.

Reset Command File

The `reset.cmd` command file is a Debugger system command file. The Reset command file executes after clicking the reset button, selecting **Connection Name > Reset** in the menu (**Connection Name** is the real name of the connection, such as **MMDS0508** or **SDI**) `reset.cmd` or selecting *Command Line* command.

Specify the Reset command file full name and status (enable/disable) either with the `CMDFILE RESET` Command Line command or using the **Reset** property tab of the [Connection Command File Window](#).

The default settings enable the `RESET.CMD` file located in the current project directory as the current Reset command file.

Preload Command File

The `preload.cmd` command file is a Debugger system command file. The Preload command file executes before an application loads to the target system through the connection, or by selecting **Connection Name > Load**.

Specify the Preload command file full name and status (enable/disable) either with the `CMDFILE PRELOAD` Command Line command or using the **Preload** property tab of the [Connection Command File Window](#).

The default settings enable the `PRELOAD.CMD` file located in the current project directory as the current Preload command file.

Postload Command File

The `postload.cmd` command file is a Debugger system command file. Postload executes after an application loads to the target system through the connection, or by selecting **Connection Name > Load**.

Specify the Postload command file full name and status (enable/disable) either with the `CMDFILE POSTLOAD` Command Line command or by using the **Postload** property tab of the [Connection Command File Window](#).

The default settings enable the `POSTLOAD.CMD` file located in the current project director as the current Postload command file.

Component Menu

The Component menu is shown in [Figure 2.20](#).

Debugger Interface

Debugger Main Window

Figure 2.20 Component Menu

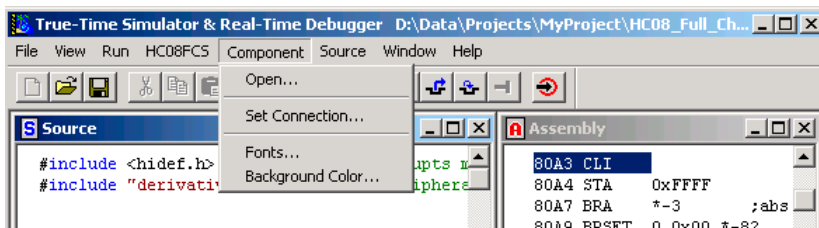

Table 2.6 describes the Component Menu entries.

Table 2.6 Component Menu Description

Menu entry	Description
Open	Loads an extra component window that has not been loaded by the Debugger at startup. The context-sensitive dialog box presents a set of different components that are introduced in the Typical Component Window Display section.
Set Connection	Sets the Debugger connection.
Fonts	Opens a standard Font Selection dialog box, where you can set the font used by Debugger components.
Background Color	Opens a standard Color Selection dialog box, where you can set the background color used by the Debugger component windows.

NOTE For a readable display, we recommend using a proportional font (e.g., Courier, Terminal, etc.).

Select *Component* > *Open* to load an extra component window that has not been loaded by the Debugger at startup. The context-sensitive dialog box presents a set of different components that are introduced in [Debugger Components](#).

Select *Component* > *Set Connection* and the *Set Connection* dialog box shown in [Figure 2.21](#) is opened.

Figure 2.21 Set Connection Dialog Box

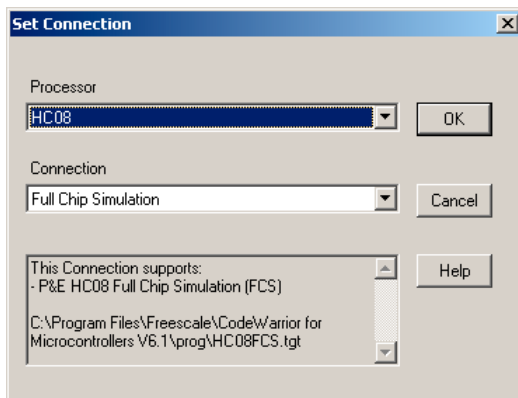

6. Use the **Processor** list menu to select the desired processor.
7. Use the **connection** list menu to select the desired connection.

A text panel displays information about the selected connection.

NOTE When a connection cannot be loaded, the combo box displays the correct path for you to install the missing DLL.

8. Click **OK** to load connection in debugger.

NOTE For more information about which connection to load and how to set/reset a connection, refer to the other sections of this manual.

Window Menu

In this menu, shown in [Figure 2.22](#), you can set the component windows general arrangement. The Submenu *Window > Options* is shown in [Figure 2.23](#) and the Submenu *Window > Layout* in [Figure 2.24](#).

Figure 2.22 Window Menu



Figure 2.23 Window Menu Options SubMenu

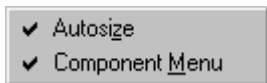
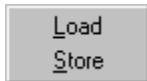

Figure 2.24 Window Menu Layout SubMenu



[Table 2.7](#) specifies the Window Menu entries.

Table 2.7 Window Menu Description

Menu entry	Description
Cascade	Option to arrange all open windows in cascade (so they overlap).
Tile	Option to display all open windows in tile format (non overlapping).
Arrange Icons	Arranges icons at the bottom of windows.
Options - Autosize	Component windows always fit into the debugger window whenever you modify the debugger window size.
Options - Component Menu	When a component window is selected, the associated menu is displayed in the main menu. For example if you select the Source window, the Source menu is displayed in the main menu.
Layout - Load/Store	Option to Load / Store your arrangements from a .HWL file.

NOTE Autosize and Component Menu are checked by default.

Help Menu

This is the Debugger Main window Help menu ([Figure 2.25](#)). [Table 2.8](#) shows menu entries.

Figure 2.25 Help Menu

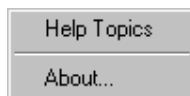

Table 2.8 Help Menu Description

Menu entry	Description
Help Topics	Choose Help Topics in the menu for online help or if you need specific information about a topic.
About	Information about the debugger version and copyright, and license information is displayed.

About Box

Select *Help > About* to display the About box. The about box lists directories for the current project, system information, program information, version number and copyright. It contains information to send for Registration. You can copy this information and send to `license@freescale.com`.

For more information on all components, click on the **Extended Information** button.

Two hypertext links allow you to send an E-mail for a license request or information, and open the Freescale internet home page.

Click on **OK** to close this dialog box.

Component Associated Menus

Various Debugger Component windows are shown in [Figure 2.3](#). Each component window loaded by default or that you have loaded has two menus. One menu is in the main menu and the other one is a context menu (also called *Associated Context Menu*) that you can open by right-clicking in a window component. Note that before right-clicking, the component window has to be active.

Component Main Menu

This menu, shown in [Figure 2.26](#) is always between the Component entry and the Window entry of the Debugger main window toolbar. It contains general entries of the current active component. You can hide this menu by unchecking *Window > Options > Component Menu*.

Figure 2.26 Example of Component Main Menu

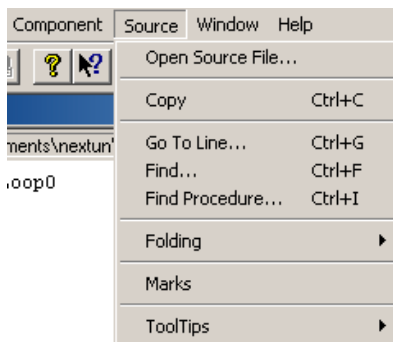

Component Files

Each component is a windows file with a .wnd extension

Component Windows Object Info Bar

The object info bar of the debugger window, as shown in [Figure 2.27](#), provides information about the selected object.

Figure 2.27 Object Info Bar of Debugger Component Windows

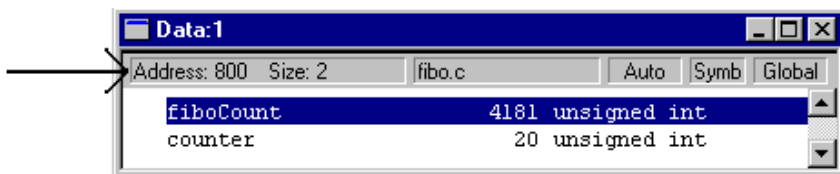

Component Context Menu

The context menu is a dynamic context sensitive menu. It contains entries for additional facilities available in the current component. Depending on the position of the mouse in the window and what is being pointed to, context menu entries differ.

Figure 2.28 Example of Component Context Menu

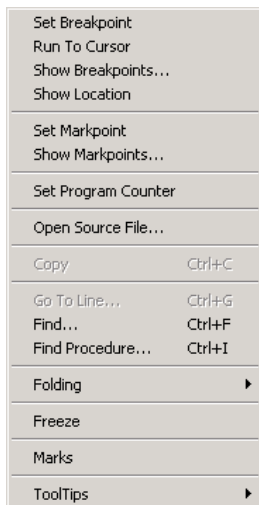

For example, if you click the mouse on a breakpoint, menu options allow you to delete, enable, or disable the breakpoint.

Highlights of the User Interface

This section describes some of the main features of the Debugger user interface.

Activating Services with Drag and Drop

You can activate services by dragging objects from one component window to another. This is known as drag and drop, an example is shown in [Figure 2.29](#).

Figure 2.29 Drag and Drop Example

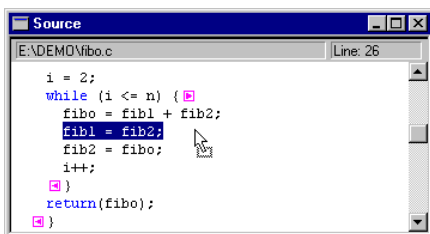

When the dragged item is not allowed in the destination to which you are dragging the item, the following cursor symbol is displayed:

Example:

You can activate the display of coverage information on assembler and C statements by dragging the chosen procedure name from the Coverage component to the Source and Assembly components ([Figure 2.30](#)).

Figure 2.30 Dragging Procedure Name from Coverage to Source Component Window

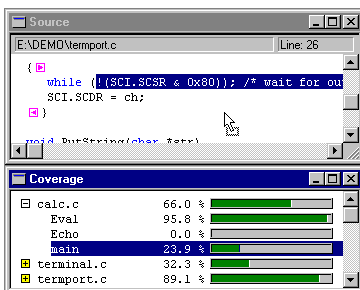

You can display the memory layout corresponding to the address held in a register by dragging the address from the Register Component to the Memory Component.

To Drag and Drop an Object

To drag an object from one component window to another:

1. Select the component containing the object you want to drag.
2. Make sure the destination component window where you want to drag the object is visible.
3. Select the object you want.
4. Press and hold the left mouse button, drag the object into the destination component window and then release the mouse button.

Drag and Drop Combinations

Dragging and dropping objects is possible between different component windows and are introduced in each component description section.

See below, the possible combinations of drag and drop between components and associated actions. When additional components are available, new combinations might be possible and described in the component's information manual.

Dragging from Assembly Component Window

[Table 2.9](#) summarizes dragging from the Assembly Component.

Table 2.9 Dragging from the Assembly Component Window

Destination Component Window	Action
Command Line	The Command Line component appends the address of the "pointed to" instruction to the current command.
Memory	Dumps memory starting at the selected instruction PC. The PC location is selected in the memory component.
Register	Loads the destination register with the PC of the selected instruction.
Source	Source component scrolls up to the source statements and highlights it.

Dragging from Data Component Window

[Table 2.10](#) summarizes dragging from the Data Component.

Table 2.10 Dragging from the Data Component Window

Destination Component Window	Action
Command Line	Dragging the name appends the address range of the variable to the current command in the Command Line Window. Dragging the value appends the variable value to the current command in the Command Line Window.
Memory	Dumps memory starting at the address where the selected variable is located. The memory area where the variable is located is selected in the memory component.
Register	Dragging the name loads the destination register with the address of the selected variable. Dragging the value loads the destination register with the value of the variable.
Source	Dragging the name of a global variable in the source window displays the module where the variable is defined and the source text is searched for the first occurrence of the variable and highlighted.

NOTE It is not possible to drag an expression defined with the Expression Editor. The “forbidden” cursor is displayed.

Dragging from Source Component Window

[Table 2.11](#) summarizes dragging from the Source Component.

Table 2.11 Dragging from the Source Component Window

Destination Component Window	Action
Assembly	Displays disassembled instructions starting at the first high level language instruction selected. The assembler instructions corresponding to the selected high level language instructions are highlighted in the Assembly component
Register	Loads the destination register with the PC of the first instruction selected.
Memory	Displays the memory area corresponding with the high level language source code selected. The memory area corresponding to the selected instructions are grayed in the memory component.
Data	A selection in the Source window is considered an expression in the Data window, as if it was entered through the Expression Editor of the Data component. (See Data Component and Expression Editor .)

Dragging from the Memory Component Window

[Table 2.12](#) summarizes dragging from the Memory Component.

Table 2.12 Dragging from the Memory Component Window

Destination Component Window	Action
Assembly	Displays disassembled instructions starting at the first address selected. Instructions corresponding to the selected memory area are highlighted in the Assembly component.
Command Line	Appends the selected memory range to the Command Line window.
Register	Loads the destination register with the start address of the selected memory block.
Source	Displays high level language source code starting at the first address selected. Instructions corresponding to the selected memory area are grayed in the source component.

Dragging from Procedure Component Window

[Table 2.13](#) summarizes dragging from the Procedure Component.

Table 2.13 Dragging from the Procedure Component Window

Destination Component Window	Action
Data > Local	Displays local variables from the selected procedure in the data component.
Source	Displays source code of the selected procedure. Current instruction inside the procedure is highlighted in the Source component.
Assembly	The current assembly statement inside the procedure is highlighted in the Assembly component.

Dragging from Register Component Window

[Table 2.14](#) summarizes dragging from the Register Component Window.

Table 2.14 Dragging from the Register Component Window

Destination Component Window	Action
Assembly	Assembly component receives an address range, scrolls to the corresponding instruction and highlights it.
Memory	Dumps memory starting at the address stored in the selected register. The corresponding address is selected in the memory component.

Dragging from Module Component Window

[Table 2.15](#) summarizes dragging from the Register Component.

Table 2.15 Dragging from the Module Component Window

Destination Component Window	Action
Data > Global	Displays global variables from the selected module in the data component.
Memory	Dumps memory starting at the address of the first global variable in the module. The memory area where this variable is located is selected in the memory component.
Source	Displays source code from selected module.

Selection Dialog Box

This dialog box is used in the Debugger for opening general components or source files. You can select the desired item with the arrow keys or mouse and then the **OK** button to accept or **CANCEL** to ignore your choice. The **HELP** button opens this section in the Help File.

This dialog box is used for the following selections:

- Set Connection
- Open IO component
- Open Source File
- Open Module
- Individual component window



Debugger Interface

Highlights of the User Interface

Debugger Components

This chapter explains how the different components of the Debugger work. This chapter contains the following sections:

- [Component Introduction](#)
- [Loading Component Windows](#)
- [General Debugger Components](#)
- [Visualization Utilities](#)

Component Introduction

The Debugger kernel includes various components.

CPU Components

CPU components handle processor-specific properties such as register naming, instruction decoding (disassembling), and stack tracing. A specific implementation of the CPU module must be provided for each processor type that is supported in the debugger. The CPU-related component is not introduced in this section. However, the Register component, Memory component, and all other Connection-dependent components reflect this system component. The appropriate CPU component loads automatically when loading an application or executable file (.ABS file), therefore it is possible to mix applications for different MCUs. The Debugger automatically detects the MCU type and loads the appropriate CPU component, if available on your environment.

Window Components

The Debugger main window components are small applications loaded into the debugger framework at run-time. Window components can access all global facilities of the debugger engine, such as the connection (to communicate with different connections), and the symbol table. The Debugger window components are implemented as dynamic link libraries (DLLs) with extension .WND. These components are introduced in this section.

Connection Components

Different debugger connections are available. For example, you can set a CPU awareness to simulate your .ABS application files, and also set a background debugger.

Different connections are available to connect the target system (hardware) to the debugger. For example, the connection may be connected using a Full Chip Simulator, an Emulator, a ROM monitor, a BDM pod cable, or any other supported device.

NOTE Connection components are introduced in their respective manuals.

Loading Component Windows

In the Debugger Main Window Menu Bar, shown in [Figure 3.1](#), you can use the Component menu to load all framework components. Each Debugger component you select appears as a window in the Debugger main window.

Figure 3.1 Debugger Window Menu Bar

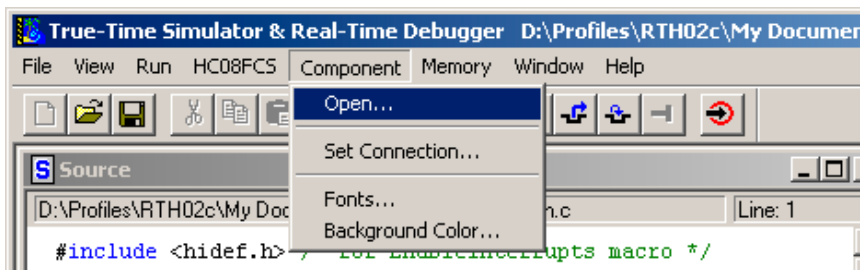

To open the window that lets you choose one or more components:

1. Choose *Component > Open*
2. In the Open Window Component window shown in [Figure 3.2](#), select the desired component.

NOTE To open more than one component, select multiple components.

Figure 3.2 Open Window Component Window

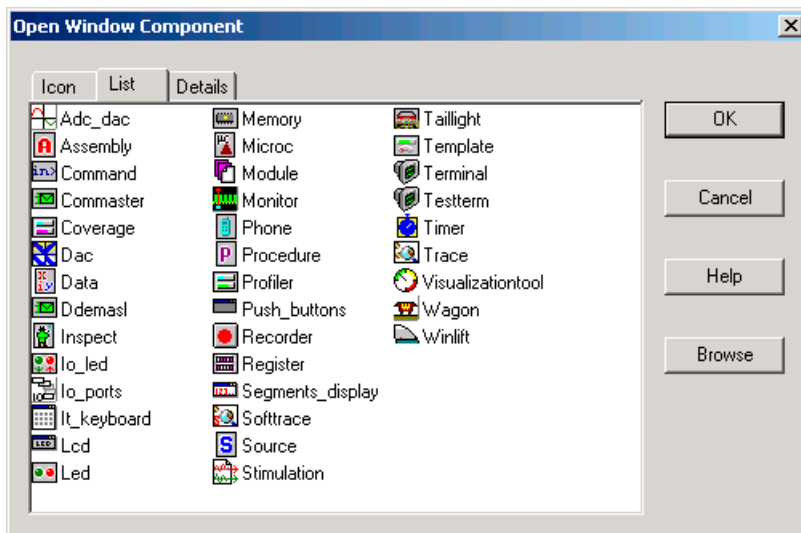

3. In the Open Window Component window, use the mouse to select a component.
4. Click the **OK** button to open the selected component.

There are three tabs in the Open Window Component window:

- The **Icon** tab shows components with large icons.
- The **List** tab shows components with small icons.
- The **Details** tab shows components with their description.

Demo Version Limitations

The demo version limits the number of components you can open at a time. If you use the demo version, you can open a maximum of eight components.

General Debugger Components

This section describes the various features and usage of the debugger components.

Assembly Component

The Assembly window, shown in [Figure 3.3](#), displays program code in disassembled form. It has a function very similar to that of the Source component window but on a much lower abstraction level. Thus it is therefore possible to view, change, monitor and control the current location of execution in a program.

Figure 3.3 Assembly Window

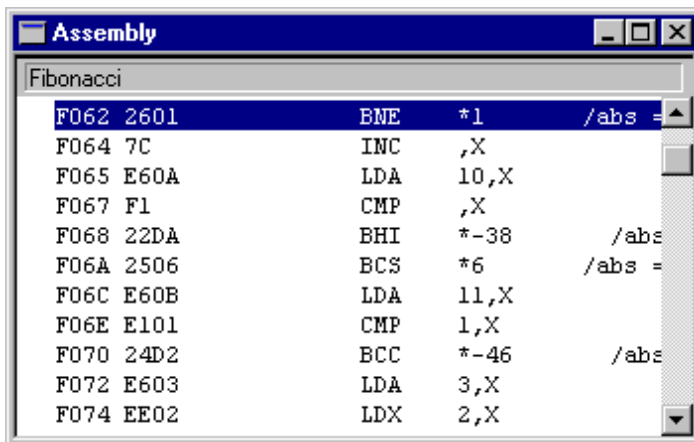

This window contains all on-line disassembled instructions generated by the loaded application. Each displayed disassembled line in the window can show the following information: the address, machine code, instruction and absolute address in case of a branch instruction. By default, the user can see the instruction and absolute address.

If breakpoints have been set in the application, they are marked in the Assembly component with a special symbol, depending on the kind of breakpoint.

If execution has stopped, the current position is marked in the Assembly component by highlighting the corresponding instruction.

The Object Info Bar of the component window contains the procedure name, which contains the currently selected instruction. When a procedure is double clicked in the Procedure component, the current assembly statement inside this procedure is highlighted in the Assembly component.

Assembly Menu

The *Assembly* menu shown in [Figure 3.4](#) contains all functions associated with the assembly component. [Table 3.1](#) describes these menu entries.

Figure 3.4 Assembly Menu

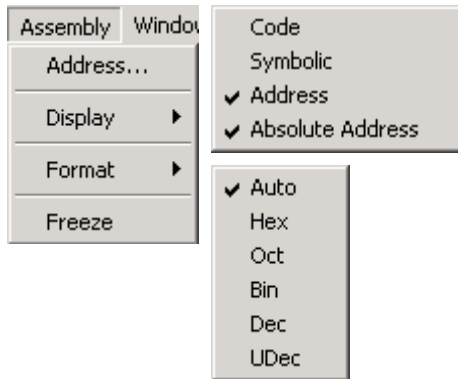

Table 3.1 Assembly Menu Description

Menu Entry	Description
Address	Opens a dialog box prompting for an address: Show PC.
Display	
Code	Displays machine code in front of each disassembled instruction.
Symbolic	Displays symbolic names of objects.
Address	Displays the location address at the beginning of each disassembled instruction.
Absolute Address	In a branch instruction, displays the absolute address at the end of the disassembled instruction.
Format	Select formatting; choose Auto, Hexadecimal, Octal, Binary, Decimal, or Unsigned Decimal
Freeze	Both the Assembly and Source components can be frozen. These components usually display the code execution from the current PC. When you freeze these components, they no longer follow the current PC but are frozen to their current displays.

Setting Breakpoints

Breakpoints can be set, edited and deleted when using the context menu. Right-click on any statement in the Source component window, then choose Set Breakpoint, Delete Breakpoint, etc.

NOTE For information on using breakpoints, see [Control Points](#) chapter.

Show PC Dialog Box

If a hexadecimal address is entered in the Show PC dialog box shown in [Figure 3.5](#), memory contents are interpreted and displayed as assembler instructions starting at the specified address.

Figure 3.5 Show PC Dialog Box

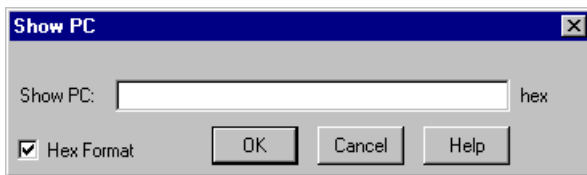

Associated Context Menu

To open the context menu right-click in the text area of the Assembly component window. The context menu contains default menu entries for the Assembly component. It also contains some context dependent menu entries described in [Table 3.2](#); depending on the current state of the debugger. Menu contents vary when the DBG module is available.

Figure 3.6 Assembly Context Menu

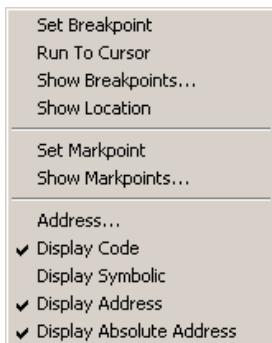

Table 3.2 Assembly Context Menu Description

Menu Entry	Description
Set Breakpoint	Appears only in the context menu if no breakpoint is set or disabled on the pointed to instruction. When selected, sets a permanent breakpoint on this instruction. When program execution reaches this instruction, the program is halted and the current program state is displayed in all window components.
Delete Breakpoint	Appears in context menu if a breakpoint is set or disabled on the specified instruction. When selected, deletes this breakpoint.
Enable Breakpoint	Appears only in context menu if a breakpoint is disabled on an instruction. When selected, enables this breakpoint.
Disable Breakpoint	Appears in the context menu if a breakpoint is set on an instruction. When selected, disables this breakpoint.
Run To Cursor	When selected, sets a temporary breakpoint on a specified instruction and continues execution of the program. Disabling a permanent breakpoint at this position disables the temporary breakpoint as well and does not halt the program. Temporary breakpoints are automatically removed when they are reached.
Show Breakpoints	Opens the Controlpoints Configuration Window Breakpoints Tab and displays list of breakpoints defined in the application (refer to Control Points).
Show Location	When selected, highlights the source statement that generated the pointed to assembler instruction. The assembler instruction is also highlighted. The memory range corresponding to this assembler instruction is also highlighted in the memory component.
Set Markpoint	When selected, enables you to set a markpoint at this location.
Delete Markpoint	Appears in the Context Menu only if a markpoint is set at the nearest code position (visible with marks). When selected, disables this markpoint.
Show Markpoints	Opens the Controlpoints Configuration Window Markpoints Tab and displays list of markpoints defined in the application (refer to Control Points).
Address	For a description of the remaining context menu entries see Table 3.1 .

Retrieving Source Statement

- Point to an instruction in the Assembly component window, drag and drop it into the Source component window. The Source component window scrolls to the source statement generating this assembly instruction and highlights it.
- Left clicking the mouse and clicking the L key Highlights a code range in the Assembly component window corresponding to the first line of code selected in the Source component window where the operation is performed. This line or code range is also highlighted.

Drag Out

[Table 3.3](#) shows the drag actions possible from the Assembly component.

Table 3.3 Assembly Component Drag Actions

Destination Component Window	Action
Command Line	The Command Line component appends the address of the pointed to instruction to the current command.
Memory	Dumps memory starting at the selected instruction PC. The PC location is selected in the memory component.
Register	Loads the destination register with the PC of the selected instruction.
Source	Source component scrolls to the source statements and highlights it.

Drop Into

[Table 3.4](#) shows the drop actions possible in the Assembly component

Table 3.4 Drop Into Assembly Component

Source Component Window	Action
Source	Displays disassembled instructions starting at the first high level language instruction selected. The assembler instructions corresponding to the selected high level language instructions are highlighted in the Assembly component
Memory	Displays disassembled instructions starting at the first address selected. Instructions corresponding to the selected memory area are highlighted in the Assembly component.
Register	Displays disassembled instructions starting at the address stored in the source register. The instruction starting at the address stored in the register is highlighted.
Procedure	The current assembly statement inside the procedure is highlighted in the Assembly component.

Demo Version Limitations

No limitation

Associated Commands

Following commands are associated with the Assembly component:

[ATTRIBUTES](#), [SMEM](#), [SPC](#).

Command Line Component

The Command Line window shown in [Figure 3.7](#) interprets and executes all Debugger commands and functions. The command entry always occurs in the last line of the Command component. Characters can be input or pasted on the edit line.

Figure 3.7 Command Line Window



Keying In Commands

You can type Debugger commands after the **in>** terminal prompt in the Command Line Component window.

Recalling a Line from the Command Line History

To recall a command in the DOS window use either the up or down arrow, or the F3 function key, to retype the previous command.

Scrolling the Command Component Window Content

Use the left and right arrow keys to move the cursor on the line, the HOME key to move the cursor to the beginning of the line, or the END key to move the cursor to the end of the line. To scroll a page, use the PgDn (scroll down a page) or PgUp keys (scroll up a page).

Clearing the Line or a Character of the Command Line

Selected text can be deleted by pressing the left arrow. To clear the current line, press the ESC key.

Command Interpretation

The component executes the command entered and displays results or error messages, if any. Ten previous commands can be recalled using the up arrow key to scroll up or the down arrow key to scroll down. Commands are displayed in blue. Prompts and command responses are displayed in black. Error messages are displayed in red.

When a command is executed and running from the Command Line component, the component cannot be closed. In this case, if the Command Line component is closed with the window close button (X) or with the **Close** entry of the system menu, the following message is displayed:

Command Component is busy. Closing will be delayed

The Command Line component is closed as soon as command execution is complete. If the [CLOSE](#) command is applied to this Command Line component (for example, from another Command Line component), the component is closed as soon as command execution is finished.

Variable Checking in the Command Line

When specifying a single name as an expression in the command line, this expression is first checked as a local variable in the current procedure. If not found, it is checked as a global variable in the current module. If not found, it is checked as a global variable in the application. If not found, it is checked as a function in the current module. If not found, it is checked as a function in the application, finally if not found an error is generated.

Closing the Command Line During Execution

When a command is executed from a Command Line component, it cannot be closed. If the Command Line component is closed with the close button or with the 'Close' entry of the system menu, the following message is displayed 'Command Component is busy. Closing will be delayed' and the Command component is closed as soon as command execution is complete. If the 'Close' command is applied to this Command component, the Command component is closed as soon as command execution is complete.

Command Menu

[Figure 3.8](#) shows the Command menu, which is identical to the Command Context menu.

Figure 3.8 Command Menu

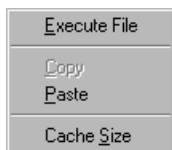

Clicking **Execute File** opens a dialog box where you can select a file containing Debugger commands to be executed. These files generally have a `.cmd` extension by default.

Selected text in the Command Line window can be copied to the clipboard by:

- Selecting the menu entry *Command > Copy*.
- Pressing the CTRL + C key.
- Clicking the  button in the toolbar.

The *Command > Copy* menu entry and the  button are only enabled if something is selected in the Command Line window.

The first line of text contained in the clipboard can be pasted where the caret is blinking (end of current line) by:

- Selecting the menu entry *Command > Paste*
- Pressing CTRL + V simultaneously.
- Clicking the  icon in the toolbar.

Cache Size

Select **Cache Size** in the menu to bring up the Size of the Cache dialog box and set the cache size in lines for the Command Line window, as shown in [Figure 3.9](#).

Figure 3.9 Cache Size Dialog Box

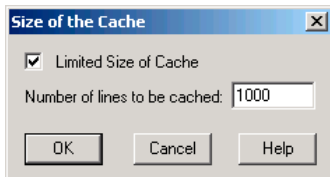

This Cache Size dialog box is the same for the Terminal Component and the TestTerm Component.

Drag Out

Nothing can be dragged out.

Drop Into

Memory range, address, and value can be dropped into the Command Line Component window, as described in [Table 3.5](#). The command line component appends corresponding items of the current command.

Table 3.5 Drop Into Command Component

Source Component Window	Action
Assembly	The Command Line component appends the address of the pointed to instruction to the current command.
Data	Dragging the name appends the address range of the variable to the current command in the Command Line Window. Dragging the value appends the variable value to the current command in the Command Line Window.
Memory	Appends the selected memory range to the Command Line window.
Register	The address stored in the pointed to register is appended to the current command.

Demo Version Limitations

Only 20 commands can be entered and then command component is closed and it is no longer possible to open a new one in the same Debugger session.

Command files with more than 20 commands cannot be executed.

Associated Commands

[BD](#), [CF](#), [E](#), [HELP](#), [NB](#), [LS](#), [SREC](#), [SAVE](#).

NOTE For more details about commands, refer to [Debugger Engine Commands](#).

Coverage Component

The Coverage window, shown in [Figure 3.10](#) contains source modules and procedure names as well as percentage values representing the proportion of executed code in a given source module or procedure.

NOTE In cases of advanced code optimizations (like linker overlapping ROM/code areas) the coverage output/data is affected. In such a case, it is recommended to switch linker optimizations.

Figure 3.10 Coverage Window

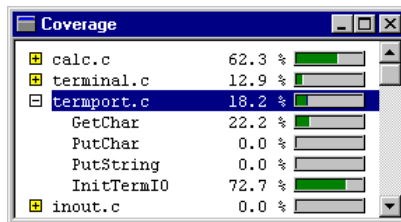

The Coverage window contains percentage numbers and graphic bars. From this component, you can split views in the Source window and Assembly window, as shown in [Figure 3.11](#). A red check mark is displayed in front of each source or assembler instruction that has been executed. Split views are removed when the Coverage window is closed or by selecting Delete in the split view context menu.

Figure 3.11 Split Views

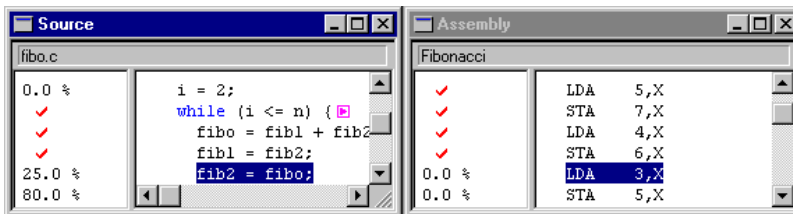

Coverage Operations

Click the folded/unfolded icons to unfold/fold the source module and display/hide the functions defined.

Coverage Menu

The Coverage menu and submenus are shown in [Figure 3.12](#).

Figure 3.12 Coverage Menu

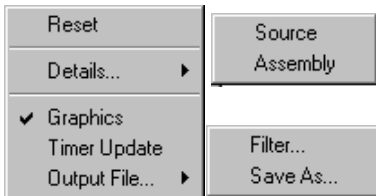

Table 3.6 Coverage Menu Description

Menu Entry	Description
Reset	Resets all simulator statistic information.
Details	Opens a split view in the chosen component (Source or Assembly).
Graphics	Toggles the graphic bars.
Timer Update	Switches the periodic update on/off. If activated, statistics are updated each second.
Output File	Opens the Output File options.

Output File

You can redirect Coverage component results to an output file by selecting *Output File > Save As* in the menu or context menu.

Output File Filter

Select *Output Filter* to display the dialog box shown in [Figure 3.13](#). Select what you want to display, i.e. modules only, modules and functions, or modules, functions and code lines. You can also specify a range of coverage to be logged in your file.

Figure 3.13 Output File Filter Dialog Box

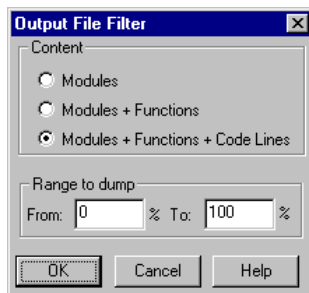

Output File Save

The *Save As* entry opens a **Save As** dialog box where you can specify the output file name and location, an example is shown in [Listing 3.1](#).

Listing 3.1 Example Output File with Modules and Functions:

Coverage:	Item:
94.4 %	Application
FULL	fibonacci.c
FULL	Fibonacci()
FULL	main()
86.0 %	startup.c
80.5 %	Init()
FULL	_Startup()

Split View Associated Context Menu

The context menu for the split view ([Figure 3.14](#)) contains the **Delete** entry, which is used to remove the split view.

Figure 3.14 Coverage Split View Associated Context Menu

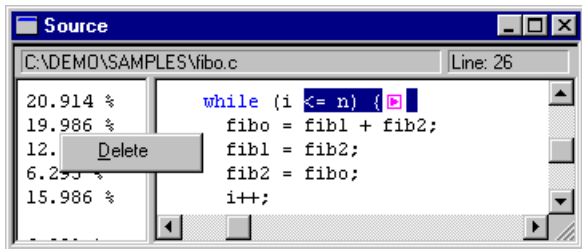

Drag Out

All displayed items can be dragged into a Source or Assembly component. Destination component displays marks in front of the executed source or assembler instruction.

Drop Into

Nothing can be dropped into the Coverage Component window.

Demo Version Limitations

Only modules are displayed and the Save function is disabled.

Associated Commands

[DETAILS](#), [FILTER](#), [GRAPHICS](#), [OUTPUT](#), [RESET](#), [TUPDATE](#)

DA-C Link Component

The DA-C Link window shown in [Figure 3.15](#) is an interface module between the DA-C (Development Assistant for C - from RistanCASE GmbH) and the IDE, allowing synchronized debugging features.

Figure 3.15 DA-C Link Window



DA-C Link Operation

When you load the DA-C Link component, communication is established with DA-C (if open) in order to exchange synchronization information.

The **Setup** entry of the DA-C Link main menu allows you to define the connection parameters.

NOTE For related information refer to the Chapter [Synchronized Debugging Through DA-C IDE](#).

DA-C Link Menu

Selecting Setup from the DA-C Link menu opens the Connection Specification dialog box.

Figure 3.16 DA-C Link Menu



Table 3.7 DA-C Link Menu Description

Menu Entry	Description
Setup	Opens the Connection Specification dialog box.

Connection Specification Dialog Box

In the Connection Specification dialog box you can set the DA-C debugger name.

Figure 3.17 Connection Specification Dialog Box

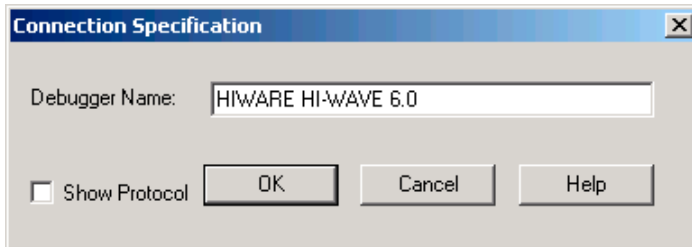

The DA-C debugger name must be the same as the one selected in the DA-C IDE. Check the **Show Protocol** checkbox to display the communication protocol in the Command component of the Debugger. To validate the settings, click the **OK** button. A new connection is established and the Connection Specification is saved in the current `Project.ini` file. The **HELP** button opens the help topic for this dialog box.

NOTE If problems exist, refer to the [Troubleshooting](#) section in the DA-C documentation.

Drag Out

Nothing can be dragged out.

Drop Into

Nothing can be dropped into the DAC Component window.

Demo Version Limitations

None.

Data Component

The Data window shown in [Figure 3.18](#) contains the names, values and types of global or local variables.

Figure 3.18 Data Window

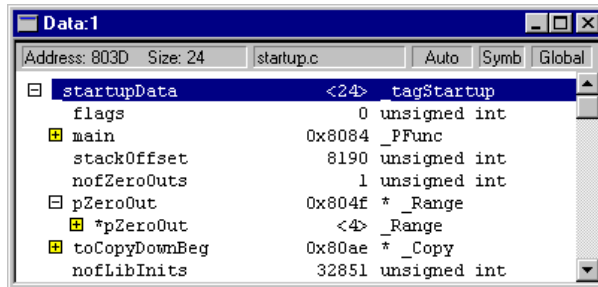

The Data window shows all variables present in the current source module or procedure. Changed values are in red.

The [Component Windows Object Info Bar](#) contains the address and size of the selected variable. It also contains the module name or procedure name where the displayed variables are defined, the display mode (automatic, locked, etc.), the display format (symbolic, hex, bin, etc.), and current scope (global, local or user variables).

Various display formats, such as symbolic representation (depending on variable types), and hexadecimal, octal, binary, signed and unsigned formats may be selected.

Structures can be expanded to display their member fields and pointers can be traversed to display data they are pointing to.

Watchpoints can be set in this component. Refer to [Control Points](#) chapter.

Data Operations

- Double-click a variable line to edit the value.
- Click the folded/unfolded icons to unfold/fold the structured variable.
- Double-click a blank line: Opens the Expression editor to insert an expression in the Data Component window.
- Select a variable in the Data component, and left mouse button + R key to set a *Read* watchpoint on the selected variable. A green vertical bar is displayed on the left side of the variables on which a read watchpoint has been defined. If a read access on the variable is detected during execution, the program is halted and the current program state is displayed in all window components.

Debugger Components

General Debugger Components

- Select a variable in the Data component, and left mouse button + W key to set a *Write* watchpoint on the selected variable. A red vertical bar is displayed on the left side of the variables on which a write watchpoint has been defined. If write access is detected on the variable during execution, the program is halted and the current program state is displayed in all window components.
- Select a variable in the Data component, and left mouse button + B key to set a *Read/Write* watchpoint on the selected variable. A yellow vertical bar is displayed for the variables on which a read/write watchpoint has been defined. If the variable is accessed during execution, the program is halted and the current program state is displayed in all window components.
- Select a variable on which a watchpoint was previously defined in the Data component, and left mouse button + D key to delete the watchpoint on the selected variable. The vertical bar previously displayed for the variables is removed.
- Select a variable in the Data component, and left mouse button + S key to set a watchpoint on the selected variable. The Watchpoints Setting dialog box opens. A gray vertical bar displays for the variables on which an watchpoint has been defined.

Expression Editor

To add your own expression (in EBNF notation) double-click a blank line in the Data component window to open the **Edit Expression** dialog box shown in [Figure 3.19](#), or point to a blank line as shown below and right-click to select **Add Expression** in the context menu shown in the figure below.

You may enter a logical or numerical expression in the edit box, using the Ansi-C syntax. In general, this **expression** is a function of one or several variables from the current Data component window.

Figure 3.19 Edit Expression Dialog Box

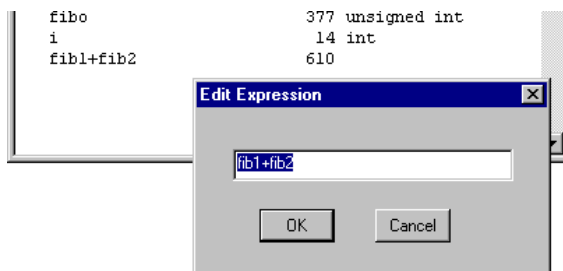

Example:

With two variables `variable_1`, `variable_2`:

expression entered: `(variable_1<<variable_2)+ 0xFF) <= 0x1000` results in a boolean type.

expression entered: `(variable_1>>~variable_2)* 0x1000` results in an integer type.

NOTE It is not possible to drag an expression defined with the Expression Editor. The **forbidden** cursor is displayed.

Expression Command file

The Expression Command file is automatically generated when a new application is loaded or exiting from the Debugger. User defined expressions are stored in this command file. The name of the expression command file is the name of the application with a `.xpr` extension (`.XPR` file). When loading a new user application, the debugger executes the matching expression command file to load the user defined expression into the data component.

Example: When loading `fibonacci.abs`, the debugger executes `Fibonacci.xpr`

Data Menu

[Figure 3.20](#) shows the Data component menu, the Zoom submenu is shown in [Figure 3.29](#), the Scope submenu is shown in [Figure 3.21](#), the Format submenu in [Figure 3.22](#), the Mode submenu in [Figure 3.24](#), the Options submenu in [Figure 3.26](#) and the Zoom and Sort submenus in [Figure 3.29](#). [Table 3.8](#) describes the Data Menu entries.

Figure 3.20 Data Menu

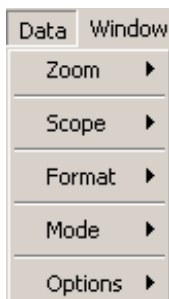

Table 3.8 Data Menu Entry Description

Menu Entry	Description
Zoom	Zooms in or out of the selected structure. The member field of the structure replaces the variable list.
Scope	Opens a variable display submenu.
Format	Symb, Hex (hexadecimal), Oct (octal), Bin (binary), Dec (signed decimal), UDec (unsigned decimal) display format.
Mode	Switches between Automatic, Periodical, Locked, and Frozen update mode.
Options	Opens an options menu for data, for example, Pointer as Array facility.

Scope Submenu

The Scope Submenu is activated by highlighting the Scope entry on the Data menu:

Figure 3.21 Scope Submenu



[Table 3.9](#) describes the Scope submenu entries.

Table 3.9 Scope Submenu Entries

Menu Entry	Description
Global	Switches to Global variable display in the Data component.
Local	Switches to Local variable display in the Data component.
User	Switches to User variable display in the Data component. Displays user defined expression (variables are erased).

NOTE If the data component mode is not automatic, entries are grayed (because it is not allowed to change the scope).

In Local Scope, if the Data component is in Locked or Periodical mode, values of the displayed local variables may be invalid (since these variables are no longer defined in the stack).

Format Submenu

The Format Submenu is activated by highlighting the format entry on the Data menu:

Figure 3.22 Format Submenu

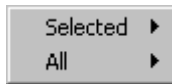

[Table 3.10](#) describes the Format submenu entries.

Table 3.10 Format Submenu Entries

Menu Entry	Description
Selected	Applies changes to the selection only
All	Applies changes to all items

Format Selected and All Sub Menu

The Format Selected and All submenu is activated by highlighting this entry on the Data Component menu:

Figure 3.23 Format Selected and All Submenus

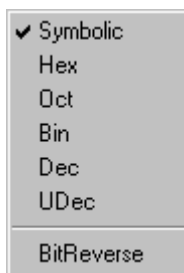

[Table 3.11](#) describes the Format Selected Mode and Format All Mode Submenu entries.

Table 3.11 Format Selected and All Submenu

Menu entry	Description
Symbolic	Select the Symbolic (display format depends on the variable type) display format. This is the default display.
Hex	Select the hexadecimal data display format
Bin	Select the binary data display format
Oct	Select the octal data display format
Dec	Select the signed decimal data display format
UDec	Select the unsigned decimal data display format
Bit Reverse	Select the bit reverse data display format (each bit is reversed).

Mode Submenu

The Mode Submenu is activated by highlighting the **Mode** entry on the Data menu:

Figure 3.24 Mode Submenu

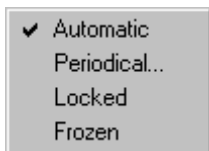

[Table 3.12](#) describes the Mode submenu entries.

Table 3.12 Mode Submenu

Menu Entry	Description
Automatic	Switches to Automatic mode (default); variables are updated when the connection is stopped. Variables from the currently executed module or procedure are displayed in the data component.
Periodical	Switches to Periodical mode; variables are updated at regular time intervals when the connection is running. The default update rate is 1 second, but can be modified by steps of up to 100 ms using the associated dialog box (see below).

Table 3.12 Mode Submenu (continued)

Menu Entry	Description
Locked	Switches to Locked mode; value from variables displayed in the data component are updated when the connection is stopped.
Frozen	Switches to Frozen mode; value from variables displayed in the data component are not updated when the connection is stopped.

NOTE In Locked and Frozen mode, variables from a specific module are displayed in the data component. The same variables are always displayed in the data component.

Update Rate Dialog Box

The Update Rate dialog box shown in [Figure 3.25](#) allows you to modify the default update rate using steps of 100 ms.

Figure 3.25 Update Rate Dialog Box

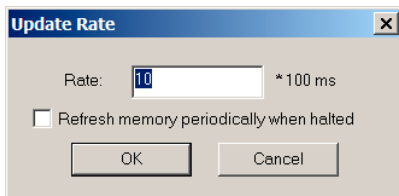

Options Submenu

The Options submenu is activated by highlighting the Options entry on the Data menu:

Figure 3.26 Options Submenu

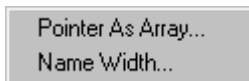

Pointer as Array Option

In the Data menu's Options submenu, choose *Options > Pointer as Array* to open the dialog box shown in [Figure 3.27](#).

Figure 3.27 Pointer as Array Dialog Box

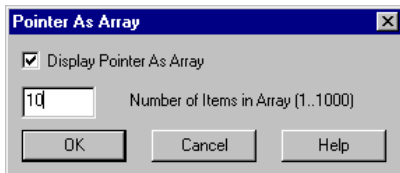

Within this dialog box, you can display pointers as arrays, assuming that the pointer points to the first item (**pointer[0]**). Note that this setup is valid for all pointers displayed in the Data window. Check the **Display Pointer as Array** checkbox and set the number of items that you want to be displayed as array items.

Name Width Option

In the Data Menu's Options submenu, choose *Options > Name Width* to open the dialog box shown in [Figure 3.28](#).

Figure 3.28 Edit Name Width Dialog Box

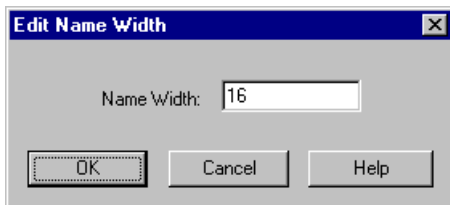

This dialog box allows you to adjust the width of the variable name displayed in the Data window. This string is cut off if longer than 16 characters. Thus, by enlarging the value you can adapt the window to longer names.

Zoom and Sort Submenus

Figure 3.29 Zoom and Sort Submenus

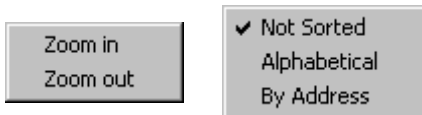

Associated Context Menu

This section describes the context menus associated with each debug component. Menu contents vary when the DBG module is available.

Figure 3.30 Data Context Menu

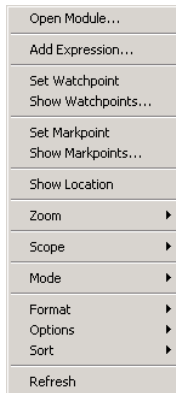

[Table 3.13](#) describes the Data Context Menu entries.

Table 3.13 Data Context Menu

Menu Entry	Description
Open Module	Opens the Open Module dialog box.
Set Watchpoint	Appears only in the context menu if no watchpoint is set or disabled on the pointed to variable. When selected, sets a read/write watchpoint on this variable. A yellow vertical bar is displayed for the variables on which a read/write watchpoint has been defined. If the variable is accessed during execution, the program is halted and the current program state is displayed in all window components.
Delete Watchpoint	Appears only in the context menu if a watchpoint is set or disabled on the pointed to variable. When selected, deletes this watchpoint.
Enable Watchpoint	Appears only in the context menu if a watchpoint is disabled on the pointed to variable. When selected, enables this watchpoint.
Disable Breakpoint	Appears only in the context menu if a breakpoint is set on the pointed to instruction. When selected, disables this watchpoint.

Debugger Components

General Debugger Components

Table 3.13 Data Context Menu (continued)

Menu Entry	Description
Show Watchpoints	Opens the Watchpoints Setting dialog box and allows you to view the list of watchpoints defined in the application. (Refer to Control Points .)
Show location	Forces all open components to display information about the pointed to variable (e.g., the Memory component selects the memory range where the variable is located).

SUBMENU Open Module

The dialog box shown in [Figure 3.31](#) lists all source files bound to the application. Global variables from the selected module are displayed in the data component. This is only supported when the component is in **Global** scope mode.

Figure 3.31 Open Modules Dialog Box

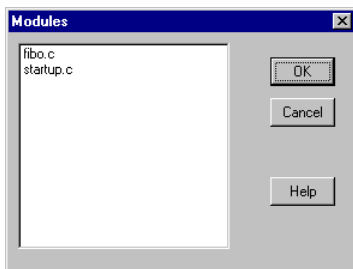

Drag Out

[Table 3.14](#) describes the drag actions possible from the Data component.

Table 3.14 Dragging Data Possibilities

Destination Component Window	Action
Command Line	Dragging the name appends the address of the variable to the current command in the Command Line Window. Dragging the value appends the variable value to the current command in the Command Line Window.
Memory	Dumps memory starting at the address where the selected variable is located. The memory area where the variable is located is selected in the memory component.

Table 3.14 Dragging Data Possibilities (continued)

Destination Component Window	Action
Source	Dragging the name of a global variable in the source Window displays the module where the variable is defined and highlights the first occurrence of the variable.
Register	Dragging the name loads the destination register with the address of the selected variable. Dragging the value loads the destination register with the value of the variable.

NOTE It is important to distinguish between dragging a variable name and dragging a variable value. Both operations are possible. Dragging the name drags the address of the variable. Dragging the variable value drags the value.

NOTE Expressions are evaluated at run time. They do not have a location address, so you cannot drag an expression name into another component. Values of expressions can be dragged to other components.

Drop Into

[Table 3.15](#) describes the drop actions possible in the Data component.

Table 3.15 Data Drop Possibilities

Source Component Window	Action
Source	A selection in the Source window is considered an expression in the Data window, as if it was entered through the Expression Editor of the Data component. Refer to Data Component, Expression Editor .
Module	Displays the global variables from the selected module in the data component.

Demo Version Limitations

Only two variables can be displayed.

Only two members of a structure are visible when unfolded.

Only one expression can be defined.

Associated Commands

[ADDXPR](#), [ATTRIBUTES](#), [DUMP](#), [PTRARRAY](#), [SMOD](#), [SPROC](#), [UPDATERATE](#), [ZOOM](#).

Memory Component

The Memory window shown in [Figure 3.32](#) displays unstructured memory content or memory dump, that is continuous memory words without distinction between variables.

Figure 3.32 Memory Window

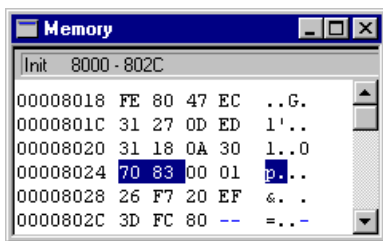

Various data formats (byte, word, double) and data displays (hexadecimal, binary, octal, decimal, unsigned decimal) can be specified for display and editing of memory content.

Watchpoints can be defined in this component.

NOTE Refer to [Control Points](#) for more information about watchpoints.

Memory areas can be initialized with a fill pattern using the [Fill Memory](#) box.

An ASCII dump can be added/removed on the right side of the numerical dump when checking/unchecking **ASCII** in the **Display** menu entry.

The location address may also be added/removed on the left side of the numerical dump when checking/unchecking **Address** in the **Display** menu entry.

To specify the start address for the memory dump use the **Address** menu entry.

The [Component Windows Object Info Bar](#) contains the procedure or variable name, structure field and memory range matching the first selected memory word.

"uu" memory value means: not initialized.

"pp" memory value means: protected from being read, or protected from being read and written.

"rr" memory value means: not accessible because the hardware is running.

"--" memory values mean: not configured (no memory available)

NOTE Memory values that have changed since the last refresh status are displayed in red. However, if a memory item is edited or rewritten with the same value, the display for this memory item remains black.

Memory Address Spaces

Some devices might have one or more additional address spaces, and the Memory window can display the different address spaces when selecting the Address Space menu entry.

When several address spaces are available, address numbers on the left side of the window are extended with the “ ’ ” sign and the space letter, to avoid confusion.

TIP HCS08 devices with Memory Management Unit (MMU) have two address spaces. The Paged address space covers regular, that is, physical/local and logical displays (see [Banked/Window Paged Memory: Physical/Local vs. Logical display](#) for further details). The Flash address space covers the Extended Address range (covering the Flash memory as one single linear range), as accessed by the Linear Address Space Pointer of the chip MMU.

Figure 3.33 HCS08 device with MMU Address Space selection

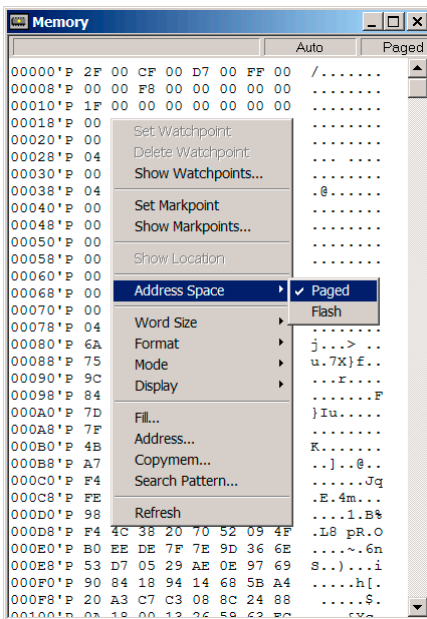

Banked/Window Paged Memory: Physical/Local vs. Logical display

This section applies only to devices having on-chip program pages or data pages. For Legacy reasons, the debugger provides two ways to display the banked/window paged memory, such as the PPAGE window \$8000-\$BFFF range with HCS08 devices with on-chip MMU, or EEPROM windows bit selectable:

- The default display is called the *physical* display in the Debugging Memory Map (DMM) interface. It is sometimes called the *local* display in device specifications and matches exactly what the CPU “sees” for silicon memory. This means that what is displayed in the Memory window at a specific suspended time (debugger halted) matches the current setup of Page registers (like PPAGE) or selection bit like EPGSEL for EEPROM, etc. Changing the page registers or selection bit and then refreshing the Memory window immediately shows changes in the window range.
- The logical display gives a constant Memory view at a specific address. For example, if we define, in a window address range, the concatenation of PPAGE<<16 added with the physical/local address, we obtain a 24-bit address that does not represent anything for the CPU, but that is directly readable by the user in the Memory window.

By default, for 8/16-bit devices, the debugger displays memory addresses above address 0xFFFF as logical. These addresses do not represent actual addresses anymore, but are still required by the debugger to synchronize the program flow display and data accesses within all windows.

The debugger defines page range accessibility in the DMM interface. Also, for 8/16-bit devices, in the physical/local \$0000-\$FFFF, the window ranges can be also defined as *logical* in the DMM interface, to make them constant at display. For example, the range \$8000-\$BFFF program window can be changed from *physical* to *paged* (also *EEPROM paged* for paged EEPROM) in the DMM graphical user interface, and the debugger no longer displays what the CPU “sees”, but always displays PPAGE \$00 when looking at addresses in the \$008000-\$00BFFF range.

The debugger provides by default a mixed display, that can be quickly changed when editing the module setup in the DMM interface. Refer to [Debugging Memory Map](#) for further details.

Memory Operations

- Double-click a memory position to edit it. If the memory is not initialized, this operation is not possible.
- Drag the mouse in the memory dump to select a memory range.

- Hold down the left mouse button + A key to jump to a memory address. The pointed to value is interpreted as an address and the memory component dumps memory starting at this address.
- Select a memory range, and hold down the left mouse button + R key to set a *Read* watchpoint for the selected memory area. Memory ranges where a read watchpoint has been defined are underlined in green. If read access on the memory area is detected during execution, the program is halted and the current program state is displayed in all window components.
- Select a memory range, and hold down the left mouse button + W key to set a *Write* watchpoint on the selected memory area. Memory ranges where a write watchpoint has been defined are underlined in red. If write access on the memory area is detected during execution, the program is halted and the current program state is displayed in all window components.
- Select a memory range, and hold down the left mouse button + B key to set a *Read/Write* watchpoint on the selected memory area. Memory ranges where a read/write watchpoint has been defined are underlined in black. If the memory area is exceeded during execution, the program is halted and the current program state is displayed in all window components.
- Select a memory range on which a watchpoint was previously defined, and hold down the left mouse button + D key to delete the watchpoint on the selected memory area. The memory area is no longer underlined.
- Select a memory range, and hold down the left mouse button + S key to set a watchpoint on the selected memory area. The Watchpoints Setting dialog box is opened. Memory ranges where a watchpoint has been defined are underlined in black.

Memory Menu

The Memory Menu shown in [Figure 3.34](#) provides access to memory commands. [Table 3.16](#) describes the menu entries.

Figure 3.34 Memory Menu

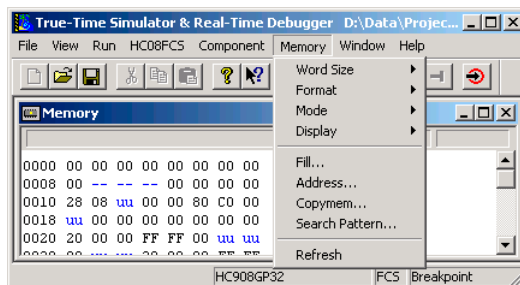

Table 3.16 Memory Menu Description

Menu Entry	Description
Word size	Opens a submenu to specify the display unit size.
Format	Opens a submenu to select the format to display items.
Mode	Opens a submenu to choose the update mode.
Display	Opens a submenu to toggle the display of addresses and ASCII dump.
Fill	Opens the Fill Memory to fill a memory range with a bit pattern.
Address	Opens the memory dialog box and prompts for an address.
CopyMem	Opens the CopyMem dialog box that allows you to copy memory range values to a specific location.
Search Pattern	Opens the Search Pattern dialog box.

Word Size Submenu

With the Word Size submenu shown in [Figure 3.35](#), you can set the memory display unit. [Table 3.17](#) describes the menu entries.

Figure 3.35 Word Size Submenu

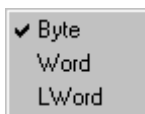

Table 3.17 Word Size Submenu Description

Menu Entry	Description
Byte	Sets display unit to byte size.
Word	Sets display unit to word size (=2 bytes).
Lword	Sets display unit to Lword size (=4 bytes).

Format Submenu

With the Format Submenu shown in [Figure 3.36](#), you can set the memory display format. [Table 3.18](#) describes the menu entries.

Figure 3.36 Format Submenu

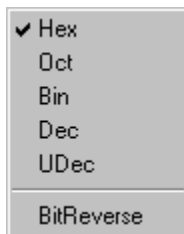

Table 3.18 Format Submenu Description

Menu Entry	Description
Hex	Selects the hexadecimal memory display format
Bin	Selects the binary memory display format
Oct	Selects the octal memory display format
Dec	Selects the signed decimal memory display format
UDec	Selects the unsigned decimal memory display format
Bit Reverse	Selects the bit reverse memory display format (each bit is reversed).

Mode Submenu

With the Mode submenu shown in [Figure 3.37](#), you can set the memory mode format. [Table 3.19](#) describes the menu entries.

Figure 3.37 Mode Submenu

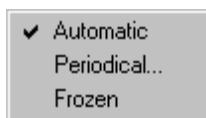

Table 3.19 Mode Submenu Description

Menu Entry	Description
Automatic	Selects Automatic mode (default), memory dump is updated when the connection is stopped.
Periodical	Selects the Periodical mode, memory dump is updated at regular time intervals when the connection is running. The default update rate is 1 second, but it can be modified by steps of up to 100 ms using the associated dialog box (see below).
Frozen	Selects the Frozen mode, memory dump displayed in the memory component is not updated when the connection is stopped.

Display Submenu

With the Display submenu shown in [Figure 3.38](#), you can set the memory display (address/ASCII). [Table 3.20](#) describes the menu entries.

Figure 3.38 Display Submenu

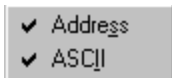

Table 3.20 Display Submenu Description

Menu Entry	Description
Address	Allows you to toggle the display of address dump.
ASCII	Allows you to toggle the display of ASCII dump.

Fill Memory

The Fill Memory dialog box shown in [Figure 3.39](#) allows you to fill a memory range (from Address edit box and to Address edit box) with a bit pattern (value edit box).

Figure 3.39 Fill Memory dialog box

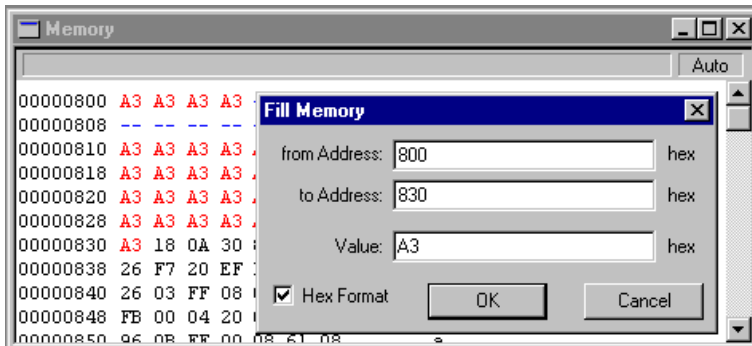

NOTE If **Hex Format** is checked, numbers and letters are interpreted as hexadecimal numbers. Otherwise, type expressions and prefix Hex numbers with **0x** or **\$**.

Display Address

With the Display Address dialog box, shown in [Figure 3.40](#), the memory component dumps memory starting at the specified address.

Figure 3.40 Display Address Dialog Box

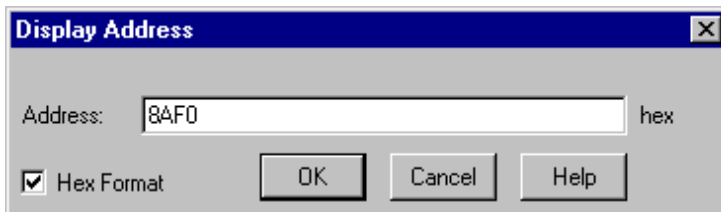

NOTE The **Show PC** dialog box is the same as the Display Address dialog box. In this dialog box, the Assembly component dumps assembly code starting at the specified address.

CopyMem Submenu

The CopyMem dialog box shown in [Figure 3.41](#) allows you to copy a memory range to a specific address.

Figure 3.41 CopyMem Dialog Box

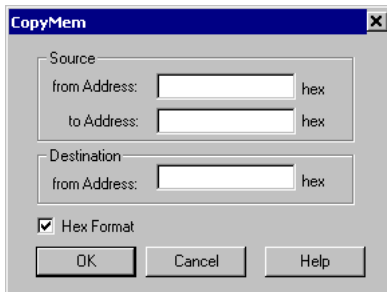

To copy a memory range to a specific address, enter the source range and the destination address. Press the **OK** button to copy the specified memory range. Press the **Cancel** button to close the dialog box without changes. Press the **Help** button to open the help file associated with this dialog box.

If **Hex Format** is checked, all given values are in Hexadecimal Format. You don't need to add 0x. For instance, type 1000 instead of 0x1000.

NOTE If you try to read or write to an unauthorized memory address, an error dialog box appears.

Search Pattern

The Search Pattern dialog box shown in [Figure 3.42](#) allows you to search memory or a memory range for a specific expression.

Figure 3.42 Search Pattern Dialog Box

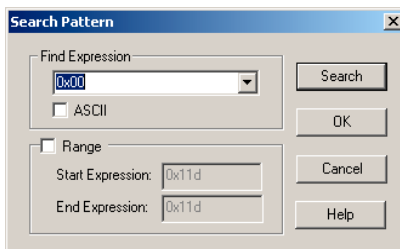

Refresh

Select the Refresh menu entry to refresh the Memory window current data cache. The debugger refreshes the data cache as if the debugger was halted or stepped.

Note that only memory ranges defined with the *Refresh memory when halting* option in the Debugging Memory Map (DMM) interface are refreshed. The Refresh menu entry addresses, by DMM factory setup, the volatile memory, i.e. the RAM and on-chip I/O Registers.

TIP To refresh other memory ranges, either set the *Refresh memory when halting* option for wanted ranges in the DMM dialog, or type/enter the DMM `RELEASECACHES` command in the Command window. You can disable caching for the debug session when typing/entering the DMM `CACHINGOFF` command in the Command window.

Update Rate

This dialog box, shown in [Figure 3.43](#), allows you to modify the update rate in steps of 100ms.

Figure 3.43 Update Rate Dialog Box

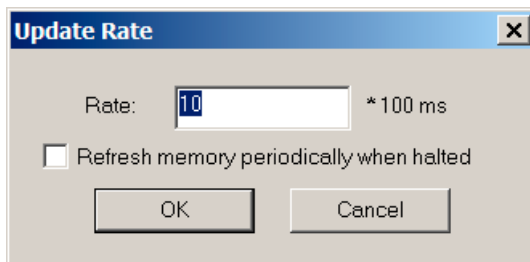

NOTE Periodical mode is not available for all hardware connections or some additional configuration may be required in order to make it work.

When you check the *Refresh memory periodically when halted* checkbox, the debugger keeps on refreshing caches even when it is not running. This allows you to see I/O Register changes even if the CPU is not running.

Memory Context Menu

The Memory Context menu allows you to execute memory associated commands. [Figure 3.44](#) shows the Memory Context menu and [Table 3.21](#) describes the menu entries. Menu contents vary when the DBG module is available.

Figure 3.44 Memory Context Menu

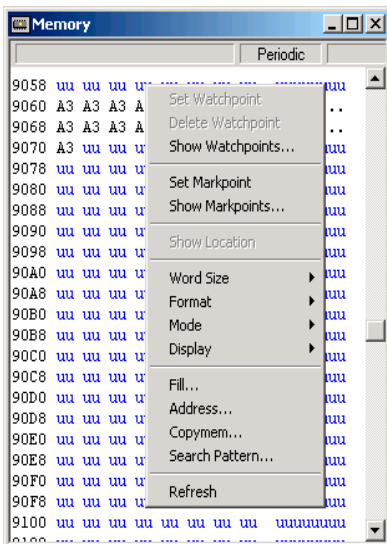

[Table 3.21](#) explains the menu entries in the Memory Context menu.

Table 3.21 Memory Context Menu Description

Menu Entry	Description
Set Watchpoint	Appears in the context menu only if no watchpoint is set or disabled on the selected memory range. When selected, sets a Read/Write watchpoint at this memory area. Memory ranges where a read/write watchpoint has been defined are underlined in yellow. If the memory area is accessed during execution of the application, the program is halted and the current program state is displayed in all window components.
Delete Watchpoint	Appears in the context menu only if a watchpoint is set or disabled on the selected memory range. When selected, deletes this watchpoint.

Table 3.21 Memory Context Menu Description (continued)

Menu Entry	Description
Show Watchpoints	When selected, brings up the Controlpoints Configuration Window - Watchpoints Tab. This is the interface through which watchpoints are controlled. (See Control Points chapter).
Set Markpoint	Appears in the context menu only if no watchpoint is set or disabled on the selected memory range. When selected, sets a Read/Write watchpoint at this memory area.
Show Markpoints	When selected, brings up the Controlpoints Configuration Window - Markpoints Tab. This is the interface through which markpoints are controlled. (See Control Points chapter).
Show Location	Forces all opened windows to display information about the selected memory area.
Word Size, etc.	The submenus are explained in Table 3.16

Drag Out

[Table 3.22](#) describes the drag actions possible from the Memory component.

Table 3.22 Memory Component Drag Possibilities

Destination Component Window	Action
Assembly	Displays disassembled instructions starting at the first address selected. The instructions corresponding to the selected memory area are highlighted in the Assembly component.
Command Line	Appends the selected memory range to the Command Line window.
Register	Loads the destination register with the start address of the selected memory block.
Source	Displays high level language source code starting at the first address selected. Instructions corresponding to the selected memory area are grayed in the source component.

Drop Into

[Table 3.23](#) shows the drop actions possible in the Memory component.

Table 3.23 Memory Component Drop Possibilities

Source Component Window	Action
Assembly	Dumps memory starting at the selected PC instruction. The PC location is selected in the memory component.
Data	Dumps memory starting at the address where the selected variable is located. The memory area where the variable is located is selected in the memory component.
Register	Dumps memory starting at the address stored in the selected register. The corresponding address is selected in the memory component.
Module	Dumps memory starting at the address of the first global variable in the module. The memory area where this variable is located is selected in the memory component.

Demo Version Limitations

No limitation

Associated Commands

[ATTRIBUTES](#), [FILL](#), [SMEM](#), [SMOD](#), [SPC](#), [UPDATERATE](#).

Module Component

The Module window shown in [Figure 3.45](#) gives an overview of source modules building the application.

Figure 3.45 Module Window

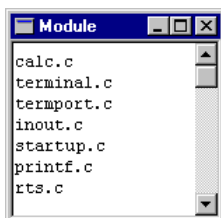

The Module component displays all source files (source modules) bound to the application. The Module window displays all modules in the order they appear in the absolute file.

Module Operations

Double-clicking a module name forces all open windows to display information about the module: the Source Component window shows the module's source and the global Data Component window displays the module's global variables.

Module Menu

The Module Component window has no menu.

Drag Out

[Table 3.24](#) shows the drag actions possible from the Module component.

Table 3.24 Module Component Drag Possibilities

Destination Component Window	Action
Data > Global	Displays the global variables from the selected module in the data component
Memory	Dumps memory starting at the address of the first global variable in the module. The memory area where this variable is located is selected in the memory component.
Source	Displays the source code from the selected module.

Drop Into

Nothing can be dropped into the Module Component window.

Demo Version Limitations

Only two modules are displayed

Procedure Component

The Procedure window shown in [Figure 3.46](#) displays the list of procedure or function calls that have been made up to the moment the program was halted. This list is known as the *procedure chain* or the *call chain*.

Figure 3.46 Procedure Window

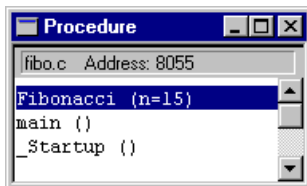

In the Procedure Component window, entries in the call chain are displayed in reverse order from the last call (most recent on top) to the first call (initial on bottom). Types of procedure parameters are also displayed.

The Object Info bar of the component window contains the source module and address of the selected procedure.

Procedure Operations

Double-clicking on a procedure name forces all open windows to display information about that procedure. The Source Component window shows the procedure's source. The local Data Component window displays the local variables and parameters of the selected procedure. The current assembly statement inside this procedure is highlighted in the Assembly component.

NOTE When a procedure of a level greater than 0 (the top most) is double clicked in the Procedure Component, the statement corresponding to the call of the lower procedure is selected in the Source Window and Assembly Window.

Procedure Menu

[Figure 3.47](#) shows the Procedure menu and its entries are described in [Table 3.25](#).

Figure 3.47 Procedure Menu

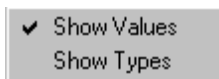

Table 3.25 Procedure Menu Description

Menu Entry	Description
Show Values	Switches to the display of function parameter values in the procedure component.
Show Types	Toggles to the display of function parameter types in the procedure component.

Drag Out

[Table 3.26](#) shows the drag actions possible from the Procedure component.

Table 3.26 Procedure Component Drag Possibilities.

Destination Component Window	Action
Data > Local	Displays the local variables from the selected procedure in the data component.
Source	Displays source code of the selected procedure. Current instruction inside the procedure is highlighted in the Source component.
Assembly	The current assembly statement inside the procedure is highlighted in the Assembly component.

Drop Into

Nothing can be dropped into the Procedure component.

Demo Version Limitations

Only the last two procedures are displayed.

Associated Commands

[ATTRIBUTES](#), [FINDPROC](#)

Profiler Component

The Profiler window shown in [Figure 3.48](#) provides information on the application profile.

NOTE In cases of advanced code optimizations (like linker overlapping ROM/code areas), the profiler output/data is affected. In such a case, it is recommended to switch linker optimizations.

Figure 3.48 Profiler Window

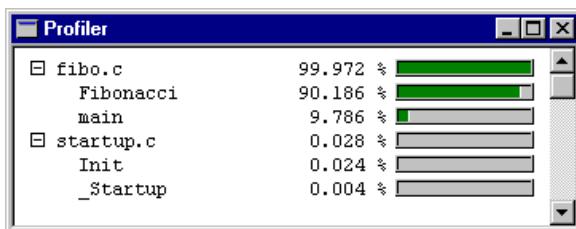

The Profiler window contains source module and procedure names and percentage values representing the time spent in each source module or procedure. The Profiler component window contains percentages and also graphic bars.

The Profiler window can set a split view in the Source and Assembly windows, as shown in [Figure 3.49](#). To obtain a split view in either the Source or Assembly windows, select: *Details > Source* or *Details > Assembly* or both from the Profiler menu and submenu. The split windows collapse when the Profiler window is closed.

Figure 3.49 Split View in the Source and Assembly Windows

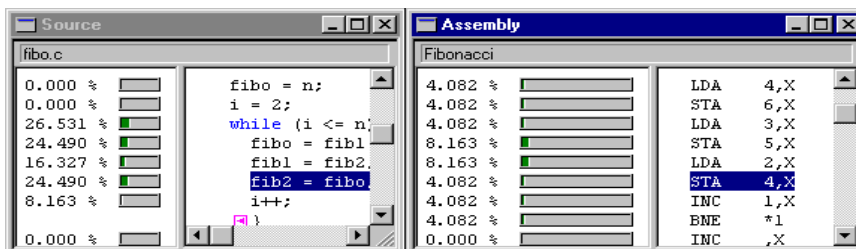

Percentage values representing the time spent in each source or assembler instruction are displayed on the left side of the instruction. The split view can also display graphic bars. Split views are removed when the Coverage component is closed or if you open the split view Context Menu and select **Delete**.

The value displayed may reflect percentages from total code or percentages from module code.

Profiler Operations

Click the fold/unfold icon to unfold/fold the source module.

Profiler Menu

[Figure 3.50](#) shows the Profiler Menu entries, with the Details submenu and the Base submenu. [Figure 3.51](#) shows the Profiler Output File submenu. Entries are described in [Table 3.27](#).

Figure 3.50 Profiler Menu and Submenus

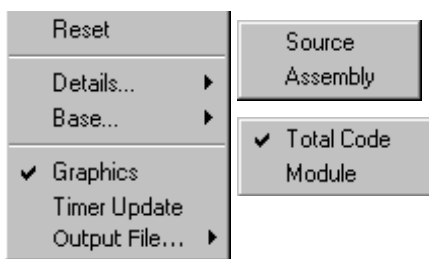

Figure 3.51 Profiler Output File Submenu

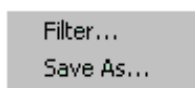

Table 3.27 Profiler Menu Entries Description

Menu Entry	Description
Reset	Resets all statistics.
Details	Sets a split view in the chosen component (Source or Assembly)
Base	Sets the base of percentage (total code or module code).
Graphics	Toggles the display from graphics bar.
Timer Update	Switches on/off the periodic update of the Coverage component. If activated, statistics are updated each second.
Output File	Set up the Profiler Output File Functions .

Split View Associated Context Menu

[Figure 3.52](#) shows the Profiler context menu, the **Delete** and **Graphics** menu entries are described in [Table 3.28](#).

Figure 3.52 Profiler Split View Associated Context Menu



Table 3.28 Profiler Split View Associated Context Menu Description

Menu Entry	Description
Delete	Removes the split view from the host component.
Graphics	Toggles the graphic bars display in the split view.

Profiler Output File Functions

You can redirect the Profiler component results to an output file by choosing *Output File > Save As* in the menu or context menu.

Output File Filter

By choosing *Output Filter*, the dialog box shown in [Figure 3.53](#) lets you select what you want to display, i.e. modules only, modules and functions, or modules and functions and code lines. You can also specify a range of coverage to be logged in your file.

Figure 3.53 Output File Filter Dialog Box

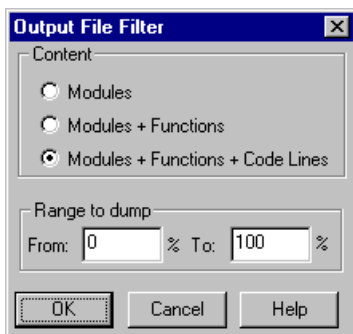

Output File Save

The *Save As* entry opens a **Save As** dialog box where you can specify the output file name and location.

Associated Context Menu

Identical to menu.

Drag Out

All displayed items can be dragged out. Destination windows may display information about the time spent in code in a split view.

Drop Into

Nothing can be dropped into the Profiler Component window.

Demo Version Limitations

Only modules are displayed and the Save function is disabled.

Associated Commands

[GRAPHICS](#), [TUPDATE](#), [DETAILS](#), [RESET](#), [BASE](#).

Recorder Component

The Recorder window shown in [Figure 3.54](#) provides record and replay facilities for debug sessions.

Figure 3.54 Recorder Window

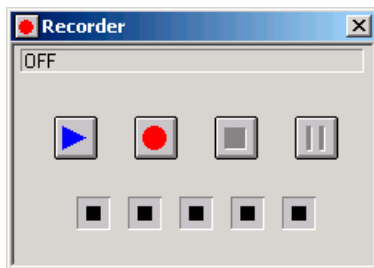

The Recorder window enables the user to record and replay command files. The recorded file may also contain the time at which the command is executed.

Click the buttons shown below to record, play, pause and stop.

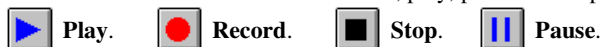

Debugger Components

General Debugger Components

An animation occurs during recording, replaying and pausing.

The current action (record, play or pause) and path of the involved file are displayed in the Object Info bar of the window.

Recorder Operations

When there is no record or play session (e.g., when the window is open), only the record and play buttons are enabled.

When you click the record button, the debugger prompts you to enter a file name. Then a record session starts and the stop button is enabled. Click the stop button to end the record session.

Clicking the replay button prompts for a file name. Command files have a `.rec` default extension and can be edited. A replay session starts and only the stop and pause buttons are enabled. When the **pause** button is clicked, file execution stops and the play and stop buttons are enabled. When the play button is clicked, file execution continues from the point it has been stopped. When the **stop** button is clicked, the replay session stops.

Terminal and TestTerm Record

Data typed in the Terminal component and TestTerm component is recorded during a record session. The resulting file can be replayed only if the time is also recorded (**Record Time** menu entry of the recorder has to be checked before recording).

Recorder Menu

The Recorder menu shown in [Figure 3.55](#) changes according to the current session. The menu items are described in [Table 3.29](#).

Figure 3.55 Recorder Menu



Table 3.29 Recorder Menu Description

Menu Entry	Description
Record	Starts recording from a debug session.
Replay	Starts replaying from a debug session.
Record Time	If set, the evolution time is also recorded. Instant 0 corresponds to the beginning of the recording.

In [Listing 3.2](#), an .abs file is loaded, a breakpoint is set, the assembly component is configured to display the code and addresses. The Data1 component display is switched to local variables, and the application starts and stops at the breakpoint.

Listing 3.2 Record File Example

```
at 4537 load C:\Freescale\DEMO\fibo.abs
at 9424 bs 0x1040 P
at 11917 Assembly < attributes code on
at 14481 Assembly < attributes adr on
at 20540 Data:1 < attributes scope local
at 24425 g
wait ;s
```

Drag Out

Nothing can be dragged out.

Drop Into

Nothing can be dropped in.

Demo Version Limitations

Only 20 commands are recorded and replayed.

Register Component

The Register window, shown in [Figure 3.56](#), displays the content of registers and status register bits of the target processor.

Figure 3.56 Register Window

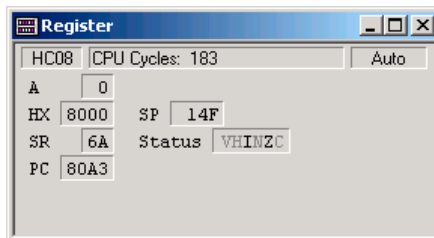

Register values can be displayed in binary or hexadecimal format. These values are editable.

TIP Many more registers and registers information might be provided by the [Inspector Component](#), in the [IO Registers](#) field.

Status Register Bits

Set bits are displayed dark, whereas reset bits are displayed gray. Double-click a bit to toggle it. During program execution, contents of registers that have changed since the last refresh are displayed in red, except for status register bits.

The Object Info bar of the window contains the number of CPU cycles as well as the processor's name.

Editing Registers

Double-click on a register to open an edit box over the register, so that the value can be modified.

Press the **ESC** key to ignore changes and retain previous content of the register.

If the **Enter** key is pressed outside the edited register, the new value is validated and the register content is changed.

If the **Tab** key is pressed, the new value is validated and the register content is changed. The next register value is selected and may be modified.

Double-clicking a status register bit toggles it.

Holding down the left mouse button and pressing the **A** key changes the contents of Source, Assembly and Memory component windows. The Source window shows the source code located at the address stored in the register. The Assembly window shows the disassembled code starting at the address stored in the register. The Memory window dumps memory starting at the address stored in the register.

Register Menu (Format Submenu)

The Register menu is pictured in [Figure 3.57](#). [Table 3.30](#) describes the menu entries.

Figure 3.57 Register Menu

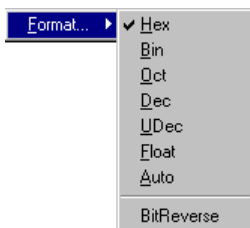

Table 3.30 Register Menu Description

Menu Entry	Description
Hex	Selects the hexadecimal register display format
Bin	Selects the binary register display format
Oct	Selects the octal register display format
Dec	Selects the signed decimal register display format
UDec	Selects the unsigned decimal register display format
Float	Selects the float register display format (all 32/64 bit registers are displayed as floats, all others as hex)
Auto	Selects the auto register display format (all floating point 32/64 bit registers are displayed as floats, all others as hex)
Bit Reverse	Selects the bit reverse data display format (Each bit is reversed).

Drag Out

[Table 3.31](#) contains the drag actions possible from the Register window.

Table 3.31 Register Component Drag Possibilities

Destination Component Window	Action
Assembly	Assembly component receives an address range, scrolls up to the corresponding instruction and highlights it.
Memory	Dumps memory starting at the address stored in the selected register. The corresponding address is selected in the memory component.
Command Line	The address stored in the pointed to register is appended to the current command.

Drop Into

[Table 3.32](#) shows the drop actions possible into the Register component.

Table 3.32 Register Component Drop Possibilities

Source Component Window	Action
Assembler	Loads the destination register with the PC of the selected instruction.
Data	Dragging the name loads the destination register with the start address of the selected variable. Dragging the value loads the destination register with the value of the variable.
Source	Loads the destination register with the PC of the first instruction selected.
Memory	Loads the destination register with the start address of the selected memory block.

Demo Version Limitations

No limitation

Associated Commands

[ATTRIBUTES.](#)

Source Component

The Source window shown in [Figure 3.58](#) displays the source code of your program, i.e. your application file.

Figure 3.58 Source Window

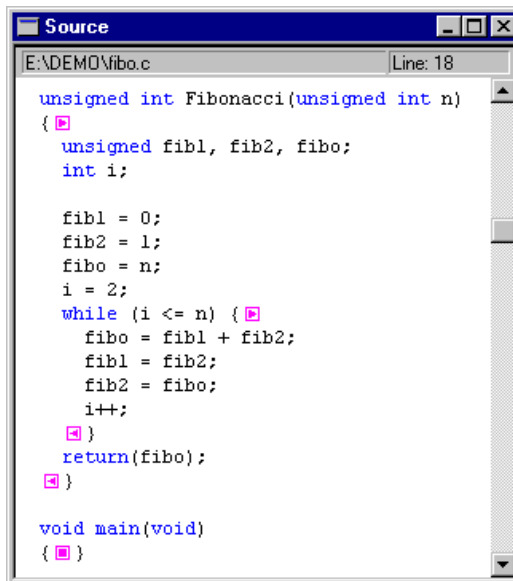

```

Source
E:\DEMO\fibonacci.c Line: 18

unsigned int Fibonacci(unsigned int n)
{
    unsigned fib1, fib2, fibo;
    int i;

    fib1 = 0;
    fib2 = 1;
    fibo = n;
    i = 2;
    while (i <= n) {
        fibo = fib1 + fib2;
        fib1 = fib2;
        fib2 = fibo;
        i++;
    }
    return(fibo);
}

void main(void)
{
}

```

The Source window allows you to view, change, monitor and control the current execution location in the program. The text displayed in the Source Component window is chroma-coded, i.e. language keywords, comments and strings are emphasized with different colors (respectively blue, green, red). A word can be selected by double-clicking it. A section of code can be selected by holding down the left mouse button and dragging the mouse.

The object info bar displays the line number in the source file of the first visible line that is at the top of the source.

Source code can be folded and unfolded. Marks (places where breakpoints may be set) can be displayed.

When the source statement matching the current PC is selected in this window,

(e.g., in a C source: `fib1 = fib2;`), the matching assembler instruction in the

Assembler component window is also selected. This instruction is the next instruction to be executed by the CPU.

If breakpoints have been set in the program, they are marked in the program source with a special symbol depending on the kind of breakpoint. For information on breakpoints refer

Debugger Components

General Debugger Components

to the [Control Points](#) chapter. If execution stops, the current position is marked in the source component by highlighting the corresponding statement.

The complete path of the displayed source file is written in the Object Info bar of this window.

NOTE You cannot edit the visible text in the Source window. This is a file viewer only.

Tool Tips Features

The Debugger source component provides tool tips to display variable values. The tool tip is a small rectangular pop-up window that displays the value of the selected variable (shown in [Figure 3.59](#)) or the parameter value and address of the selected procedure. A parameter or procedure can be selected by double-clicking it.

Figure 3.59 ToolTips Features

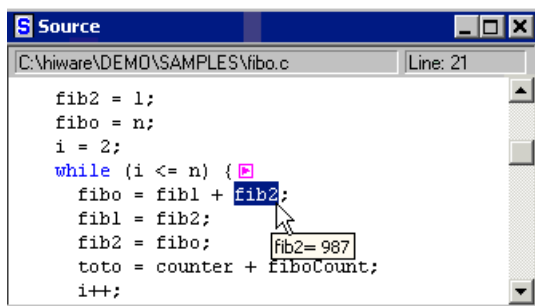

Select *ToolTips > Enable* from the source menu entry to enable or disable the tool tips feature.

Select *ToolTips > Mode* from the source menu entry to select normal or details mode, which provides more information on a selected procedure.

Select *ToolTips > Format* from the source menu entry to select the tool tip display format (Decimal, Hexadecimal, Octal, Binary or ASCII).

On-Line Disassembling

For information about performing on-line disassembly, refer to section [How to Consult Assembler Instructions Generated by a Source Statement](#).

- Select a range of instructions in the source component and drag it into the assembly component. The corresponding range of code is highlighted in the Assembly component window, as shown in [Figure 3.60](#).

- Holding down the left mouse button and pressing the T key: Highlights a code range in the Assembly component window corresponding to the first line of code selected in the Source component window where the operation is performed. This line or code range is also highlighted.

Figure 3.60 On Line Disassembling

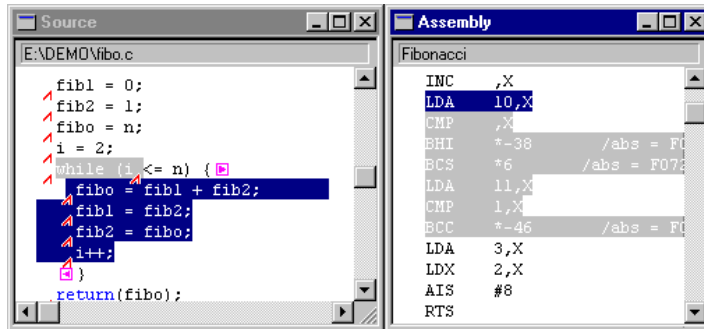

Setting Temporary Breakpoints

For information on setting breakpoints refer to the [Control Points](#) chapter.

- Point to an instruction in the Source component Window and click the right mouse button. The Source window context menu is displayed. Select **Run To Cursor** from the context menu. The application continues execution and stops at this location.
- Hold down the left mouse button and press the T key. This sets a temporary breakpoint at the nearest code position (visible with marks). The next time the program runs it breaks at this location, as shown in [Figure 3.61](#).

Figure 3.61 Setting Breakpoints

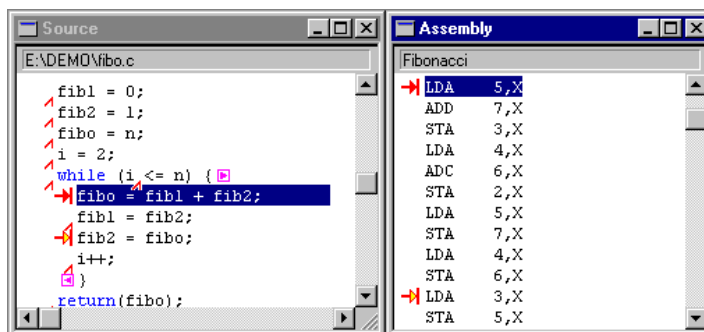







Setting Permanent Breakpoints

- Point to an instruction in the Source component Window and click the right mouse button. The Source Component context menu is displayed. Select **Set Breakpoint** from the context menu. The permanent breakpoint icon is displayed in front of the source statement pointed to.
- Holding down the left mouse button and pressing the P key: Sets a permanent breakpoint at the nearest code position (visible with marks). The permanent breakpoint icon is displayed in front of the source statement pointed to.

Folding and Unfolding

Use this feature to show or hide a section of source code (e.g., source code of a function). For example, if a section is free of bugs, you can hide it. All text is unfolded at loading.

- Sections of code that can be folded are enclosed between  and .
- Sections of code that can be unfolded are hidden under .
- Double-click a folding mark  or  to fold the text located between the marks.
- Double-click an unfolding mark  to unfold the text that is hidden behind the mark.

Source Menus

The Source Menu is shown in [Figure 3.62](#) and [Figure 3.63](#) shows the functions associated with the Source Context Menu. [Table 3.33](#) describes these functions. Menu content varies if the DBG module is available.

Figure 3.62 Source Menu

Source	Window	Help
Open Source File...		
Copy		Ctrl+C
Go To Line...		Ctrl+G
Find...		Ctrl+F
Find Procedure...		Ctrl+I
Folding		▶
✓ Marks		
ToolTips		▶

Figure 3.63 Source Associated Context Menu

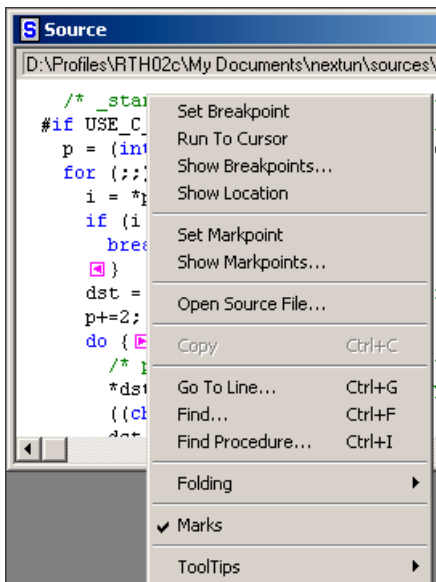

Table 3.33 Source Associated Context Menu Description

Menu Entry	Description
Set Breakpoint	Appears only in the Context Menu if no breakpoint is set or disabled at the nearest code position (visible with marks). When selected, sets a permanent breakpoint at this position. If program execution reaches this statement, the program is halted and the current program state is displayed in all window components.
Delete Breakpoint	Appears only in the Context Menu if a breakpoint is set or disabled at the nearest code position (visible with marks). When selected, deletes this breakpoint.
Enable Breakpoint	Appears only in the Context Menu if a breakpoint is disabled at the nearest code position (visible with marks). When selected, enables this breakpoint.
Disable Breakpoint	Appears only in the Context Menu if a breakpoint is set at the nearest code position (visible with marks). When selected, disables this breakpoint.

Debugger Components

General Debugger Components

Table 3.33 Source Associated Context Menu Description (*continued*)

Menu Entry	Description
Run To Cursor	When selected, sets a temporary breakpoint at the nearest code position and continues program execution immediately. Disabling a permanent breakpoint at this position disables the temporary breakpoint and prevents the program from halting. Temporary breakpoints are automatically removed when they are reached.
Show Breakpoints	Opens the Controlpoints Configuration Window's Breakpoints Tab and allows you to view the list of breakpoints defined in the application and modify their properties (See Control Points chapter).
Show Location	Highlights a code range in the Assembly component window matching the line or selected source code. The line or the source code range are highlighted as well.
Set Markpoint	Appears only in the Context Menu if a markpoint is disabled at the nearest code position (visible with marks). When selected, enables this markpoint.
Delete Markpoint	Appears only in the Context Menu if a markpoint is set at the nearest code position (visible with marks). When selected, disables this markpoint.
Show Markpoints	Opens the Controlpoints Configuration Window's Markpoints Tab and allows you to view the list of markpoints defined in the application and modify their properties (see Control Points).
Set Program Counter	The Program Counter is set to the address of the selected source code.
Open Source File	Opens the Source File dialog box if a CPU is loaded (see chapter below).
Copy (CTRL+C)	Copies the selected area of the source component into the clipboard. You can select a word by double-clicking it. You can select a text area with the mouse by moving the pointer to the left of the lines until it changes to a right-pointing arrow, and then drag up or down; automatic scrolling is activated when the text is not visible in the windows.
Go to Line (CTRL+G)	Opens a dialog box to scroll the window to a number line (see chapter below).
Find (CTRL+F)	Opens a dialog box prompting for a string and then searches the file displayed in the source component. To start searching, click Find Next , the search is started at the current selection or at the first line visible in the source component.

Table 3.33 Source Associated Context Menu Description (continued)

Menu Entry	Description
Find Procedure (CTRL+I)	Opens a dialog box for searching a procedure.
Foldings	Opens the folding window.
Marks	Toggles the display of source positions where breakpoints may be set. If this switch is on, these positions are marked by small triangles.
ToolTips	Allows you to enable or disable the source tool tips feature, to set up the tool tip mode, and tool tip format.

NOTE If some statements do not show marks although the mark display is switched on, the following reasons may be the cause:

- The statement did not produce any code due to optimizations done by the compiler.
- The entire procedure was not linked in the application, because it is never used.

Open Source File

The Open Source File dialog box shown in [Figure 3.64](#) allows you to open the Source File (if a CPU is loaded). A source file is a file that has been used to build the currently loaded absolute file. Assembly file (* .dbg) is searched in the directory given by the OBJPATH and GENPATH variables. C, C++ files (* .c,* .cpp,* .h) are searched in the directories given by the GENPATH variable.

Figure 3.64 Open Source File Dialog Box

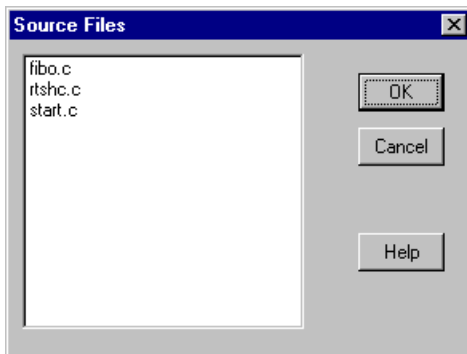

Go to Line

This menu entry is only enabled if a source file is loaded. It opens the dialog box shown in [Figure 3.65](#). In this dialog box, enter the line number you want to go to in the source component, and the selected line appears at the top of the source window. If the number is incorrect, a message appears.

Figure 3.65 Go to Line Dialog Box

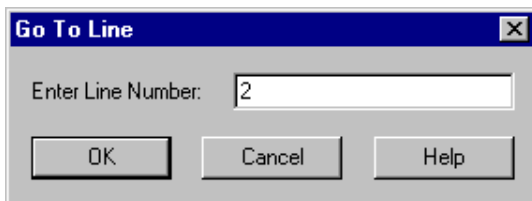

When this dialog box is open, the line number of the first visible line in the source is displayed and selected in the **Enter Line Number** edit box.

Find Operations

The Find dialog box, shown in [Figure 3.66](#) is used to perform find operations for text in the Source component. Enter the string you want to search for in the **Find what** edit box. To start searching, click **Find Next**, the search starts at the current selection or first line visible in the source component, when nothing is selected.

Use the **Up / Down** buttons to search backward or forward. If the string is found, the source component selection is positioned at the string. If the string is not found, a message is displayed.

Figure 3.66 Find Dialog Box

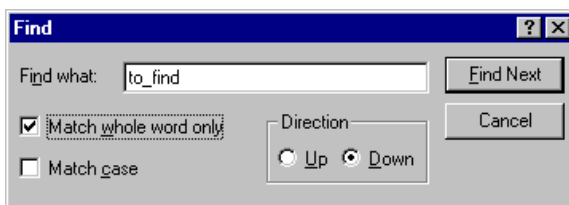

This dialog box allows you to specify the following options:

- **Match whole word only:** If this box is checked, only strings separated by special characters are recognized.
- **Match case:** If this box is checked, the search is case sensitive.

NOTE If an item (single word or source section) has been selected in the Source component window before opening the Find dialog box, the first line of the selection is copied into the **Find what** edit box.

Find Procedure

The Find Procedure dialog box, shown in [Figure 3.67](#) is used to find the procedure name in the currently loaded application. Enter the procedure name you want to search for in the **Find Procedure** edit box. To start searching, click **OK**, the search starts at the current selection or at the first line visible in the source component, when nothing is selected.

Figure 3.67 Find Procedure Dialog Box

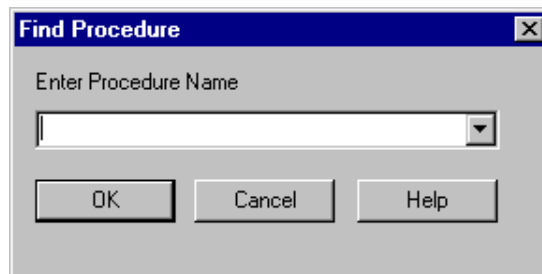

If a valid procedure name is given as a parameter, the source file where the procedure is defined is opened in the Source Component. The procedure's definition is displayed and the procedure's title is highlighted.

The drop-down list allows you to access the last searched items (classified from first to older input). Recent search items are stored in the current project file.

Folding Menu

The Folding Menu shown in [Figure 3.68](#) allows you to select the Fold functions described in [Table 3.34](#).

Figure 3.68 Folding Menu

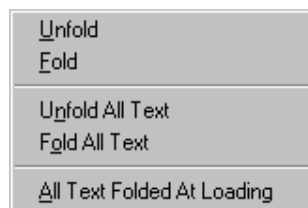

Debugger Components

General Debugger Components

Table 3.34 Folding Menu Description

Menu Entry	Description
Unfold	Unfolds the displayed source code
Fold	Folds the displayed source code
Unfold All Text	Unfolds all displayed source code
Fold All Text	Folds all displayed source code
All Text Folded At Loading	Folds all source code at load time

Drag Out

[Table 3.35](#) shows the drag actions possible from the Source component.

Table 3.35 Source Drag Possibilities

Destination Component Window	Action
Assembly	Displays disassembled instructions starting at the first high level language instruction selected. The assembler instructions corresponding to the selected high level language instructions are highlighted in the Assembly component.
Register	Loads the destination register with the PC of the first instruction selected.
Data	A selection in the Source window is considered as an expression in the Data window, as if it was entered through the Expression Editor of the Data component. (See Data Component or Expression Editor .)

Drop Into

[Table 3.36](#) shows the drop actions possible into the Source component.

Table 3.36 Source Drop Possibilities

Source Component Window	Action
Assembly	Source component scrolls to the source statements corresponding with the pointed to assembly instruction and highlights it.
Memory	Displays high level language source code starting at the first address selected. Instructions corresponding to the selected memory area are grayed in the source component.
Module	Displays source code from the selected module.

Demo Version Limitations

Only one source file of the currently loaded application can be displayed.

Associated Commands

[ATTRIBUTES](#), [FIND](#), [FOLD](#), [FINDPROC](#), [SPROC](#), [SMOD](#), [SPC](#), [SMEM](#), [UNFOLD](#).

Terminal Component

The Terminal Component window shown in [Figure 3.69](#) can be used to simulate input and output. It can receive characters from several input devices and send them to other devices.

Figure 3.69 Terminal Window

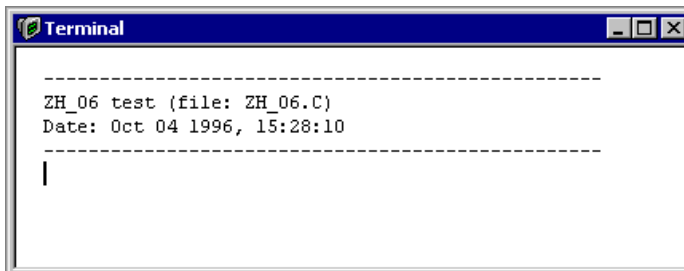

Debugger Components

General Debugger Components

You can use a virtual SCI (Serial Communication Interface) port provided by the framework for communication with the target, but it is also possible to use the keyboard, the display, some files or even the serial port of your computer as I/O-devices.

To control and configure a terminal component use the Terminal menu of the terminal shown in [Figure 3.70](#).

Figure 3.70 Terminal Menu and Context Menu

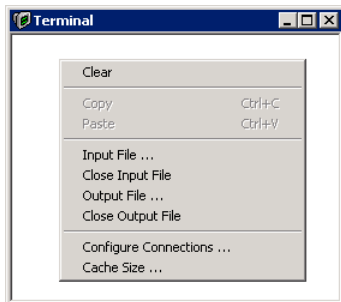

To open the context menu, right click in the terminal window.

Configure Terminal Connections

The terminal window is very flexible and can redirect characters received from any available input device to any available output device. You can specify these connections by choosing **Configure Connections** in the context menu of the terminal component. This opens the dialog box shown in [Figure 3.71](#).

Figure 3.71 Configure Terminal Connections Dialog Box

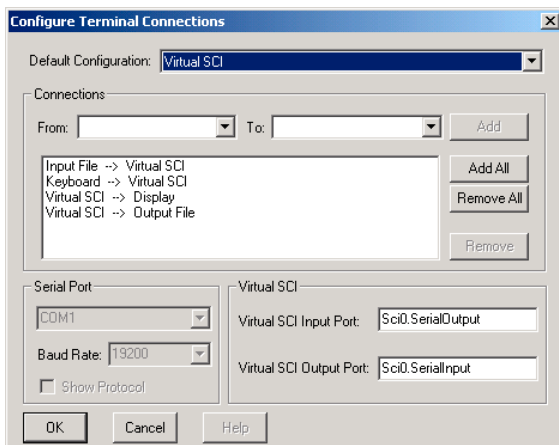

You can simply choose one of the default configurations in the **Default Configuration** combo box. In the **Connections** section all active connections are listed in a list box. There you can customize input to output device redirection by adding and removing connections.

To add a connection specify the source and target devices using the **From** and **To** combo boxes and then press the **Add** button. The new connection then appears in the list below, which shows all active connections.

To remove connections, select them in the list of active connections and press the **Remove** button.

In the **Serial Port** section you can specify which serial port to use and its properties. This is only possible if there is at least one connection from or to the serial port.

If you select a connection from or to the virtual SCI port you can also specify which ports to take as virtual SCI ports in the **Virtual SCI** section. This enables you to make a connection to any port in the FCS framework.

Input and Output File

It is also possible to take a file as an input stream for the terminal component or redirect the output to a file.

To use a file as an input stream, make sure that there exists at least one connection from the input file to any output device. Then you can open an input file by simply choosing **Input File** from the context menu. As soon as you press the **OK** button in the **File Open** dialog, input from the file starts. The file closes as soon as the end of file is reached or you choose **Close Input File** from the context menu.

When the input file has reached its end, it sends a CTRL-Z character (ASCII code 26 decimal) to all output devices receiving characters from the input file to notify them that the file transfer has been finished.

If you want to redirect some input devices to an output file, you have to proceed similarly. Make sure that you have chosen your connections from input devices to the output file. Then you can open or create your output file by choosing **Output File** from the context menu. If the file does not exist it is created. Otherwise you can choose to overwrite or append the existing file. To stop writing to the output file you can choose **Close Output File** from the context menu.

File Control Commands

It is also possible to open and close input and output files through special Escape sequences in the data stream from serial port or virtual SCI. [Table 3.37](#) illustrates the different possible commands and associated Escape sequences where filename is a sequence of characters terminated by a control character (e.g. CR) and is a valid filename.

Table 3.37 Terminal File Control Commands

Escape Sequence	Function
ESC "h" "1"	Close output file.
ESC "h" "2" filename	Open output file.
ESC "h" "3" filename	Open output file and suppress output to terminal display.
ESC "h" "4"	Close input file
ESC "h" "5" filename	Open input file.
ESC "h" "6" filename	Append to existing output file.
ESC "h" "7" filename	Append to existing output file and suppress output to terminal display.

ESC is the ESC Character (ASCII code 27 decimal).

These commands can be given in the data stream sent from the serial port or virtual SCI port, but not from the input file or the keyboard. They only have an effect if there are any connections reading from the input file or writing to the output file.

The **TERM_Direct** function declared in `terminal.h` is used to send such commands from a target via SCI to the terminal. [Listing 3.3](#) shows the source code in `terminal.c`.

Listing 3.3 TERM_Direct Source Code

```
void TERM_Direct(TERM_DirectKind what, const char* fileName) {
    /* sets direction of the terminal */
    if (what < TERM_TO_WINDOW || what > TERM_APPEND_FILE) return;
    TERM_Write(ESC); TERM_Write('h');
    TERM_Write((char)(what + '0'));
    if (what != TERM_TO_WINDOW && what != TERM_FROM_KEYS) {
        TERM_WriteString(fileName); TERM_Write(CR);
    }
}
```

In the example, the parameter `what` is one of the following constants:

- **TERM_TO_WINDOW**: send output to terminal window
- **TERM_TO_BOTH**: send output to file and window
- **TERM_TO_FILE**: send output to file `fileName`
- **TERM_FROM_KEYS**: read from keyboard (close input file)
- **TERM_FROM_FILE**: read input from file `fileName`

- **TERM_APPEND_BOTH**: append output to file and window
- **TERM_APPEND_FILE**: append output to file `fileName`

See also `terminal.h` for further details.

How to Use Virtual SCI

In its default **Virtual SCI** configuration the terminal component accesses the target through the Object Pool interface.

To make the terminal component work in this default configuration, the target must provide an object with the name **Sci0**. If no **Sci0** object is available, no input or output happens. It is possible to check, through the Inspector component, if the environment currently provides an **Sci0** object.

NOTE Only some specific Full Chip Simulation components currently have a **Sci0** object. For all other Full Chip Simulation components the default virtual SCI port does not work unless a user defined **Sci0** object with the specified register name is loaded.

Write access to the target application is done with the Object Pool function **OP_SetValue** at the address **Sci0.SerialInput**.

Input from the target application is handled with a subscription to an Object Pool register with the name **Sci0.SerialOutput**. When this register changes (sends a notification), a new value is received.

For implementations of this register with help of the **IOBase** class, use the **IOB_NotifyAnyChanges** flag. Otherwise only the first of two identical characters are received.

It is also possible to configure the terminal to use another object in the Object Pool instead of **Sci0** with which to communicate. Refer to [Configure Terminal Connections](#) for information about where you can do this.

Cache Size

The item **Cache Size** in the context menu allows you to set the number of lines in the terminal window with the dialog shown in [Figure 3.72](#).

Figure 3.72 Size of the Cache Dialog Box

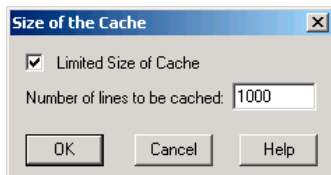

Trace Component

The Trace window shown in [Figure 3.73](#) records and displays instruction frames and time or cycles.

Figure 3.73 Trace Window

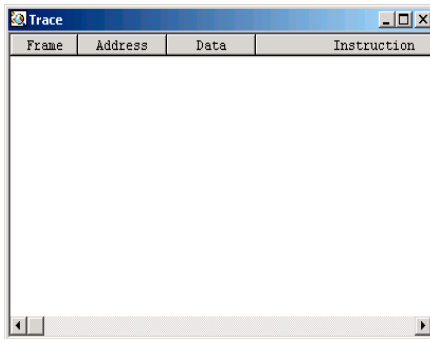

Trace Operations

Pointing at a frame and dragging the mouse forces all open windows to show the corresponding code or location. Time and cycles of all other frames are evaluated relative to this base.

Holding down the left mouse button and pressing the Z key sets the zero base frame to the pointed frame.

Holding down the left mouse button and pressing the D key forces all open component windows to show the code matching the pointed to frame.

Trace Menu

The Trace Menu shown in [Figure 3.74](#) contains the functions described in [Table 3.38](#). Trace menu entries vary depending on the connection.

Figure 3.74 Trace Menu

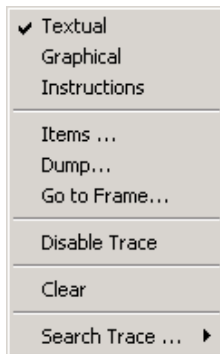

Table 3.38 Trace Menu Description

Menu Entry	Description
Textual	Displays window contents in text format.
Graphical	Displays window contents in graphical format.
Instructions	Displays instructions in window
Items	Use to specify the window display items.
Dump	Select a file to dump or a range of frames to dump.
Go to Frame	Search for a specific frame.
Disable Trace/ Enable Trace	Disable or enable tracing function.
Clear	Clears the Trace component window.
Search Trace	Use to specify search conditions (see Associated Context Menu).

Associated Context Menu

The Trace context menu shown in [Figure 3.75](#) allows you to specify trace search conditions. [Table 3.39](#) describes the menu items. (This context menu is not available with all connections.)

Debugger Components

General Debugger Components

Figure 3.75 Trace Associated Context Menu

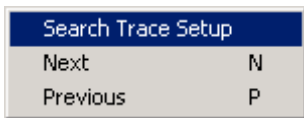
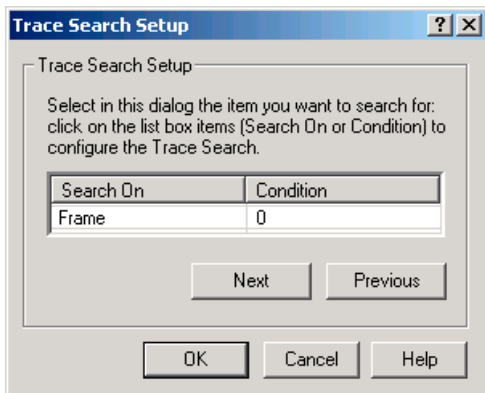

Table 3.39 Trace Associated Context Menu Description

Menu Entry	Description
Search Trace Setup	Select this menu entry to activate the Trace Search Setup dialog box (see Figure 3.76). Specify either the frame or a condition for which to search. (Not available with all connections.)
Next	Steps to the next occurrence of the condition. Pressing the N key has the same effect.
Previous	Steps back to the previous occurrence of the condition. Pressing the P key has the same effect.

Figure 3.76 Trace Search Setup Dialog Box



Drag Out

Nothing can be dragged out.

Drop Into

Nothing can be dropped in.

Demo Version Limitations

The number of frames is limited to 50.

Associated Commands

[CLOCK](#), [CYCLE](#), [FRAMES](#), [RECORD](#), [RESET](#).

Visualization Utilities

Besides components that provide the Debugger engine a well-defined service dedicated to the task of application development, the debugger component family includes utility components that extend to the productive phase of applications, such as, the host application builder components, process visualization components, etc.

Among these components, there are visualization utilities that graphically display values, registers, memory cells, etc., or provide an advanced graphical user interface to simulated I/O devices, program variables, and so forth.

The following components of the continuously growing set of visualization utilities belong to the standard Debugger installation.

Inspector Component

The Inspector window shown in [Figure 3.77](#) displays information about several topics. It displays loaded components, the visible stack, pending events, pending exceptions and loaded I/O devices.

Figure 3.77 Inspector Component Window

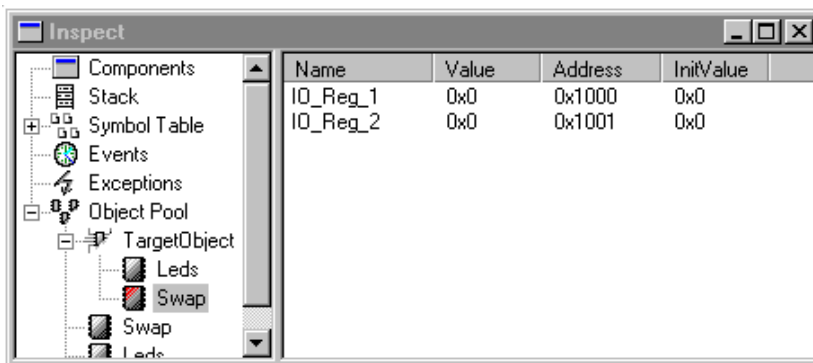

The hierarchical content of the items is displayed in a tree structure. If any item is selected on the left side, then additional information is displayed on the right side.

Debugger Components

Visualization Utilities

In the figure above, for example, the Object Pool is expanded. The Object Pool contains the TargetObject, which contains the Leds and Swap peripheral devices. The Swap peripheral device is selected and registers of the Swap device are displayed.

Components Icon

When the components icon is selected in the Inspect window, as shown in [Figure 3.78](#), the right side displays various information about all loaded components. A Component is the “unit of dynamic loading”, therefore all windows, the CPU, the connection and perhaps the connection-simulator are listed.

Figure 3.78 Inspect Window Components Icon

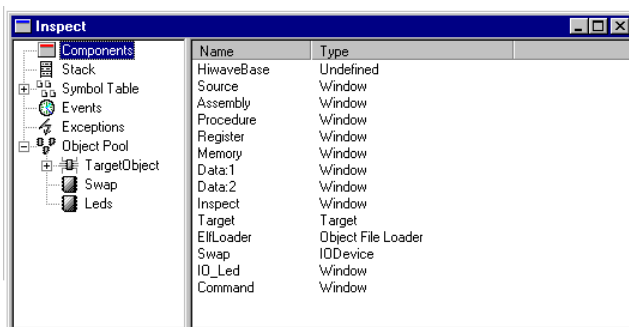

Stack Icon

The Stack icon shown in [Figure 3.79](#) displays the current stack trace. Every function on the stack has a separate icon on the trace. In the stack-trace, the content of a local variable is accessible.

Figure 3.79 Inspector Window Stack Icon

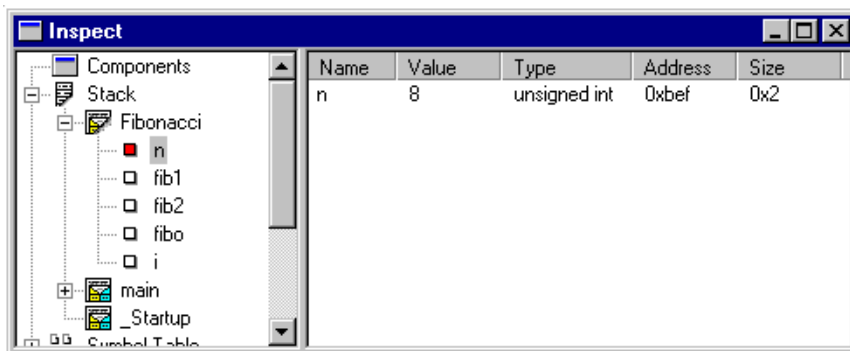

Symbol Table

The symbol table shown in [Figure 3.80](#) displays all loaded symbol table information in raw format. There are no stack frames associated with functions. Therefore the content of local variables is not displayed. Global variables and their types are displayed.

Figure 3.80 Inspector Window Symbol Table

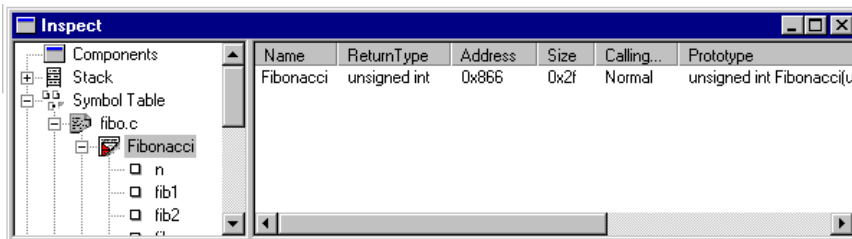

Events Icon

The Inspect window Events icon shown in [Figure 3.81](#) shows all currently installed events. Events are handled by peripheral devices, and notified at a given time. The Event display shows the name of the event and remaining time until the event occurs.

Figure 3.81 Inspector Window Events Icon

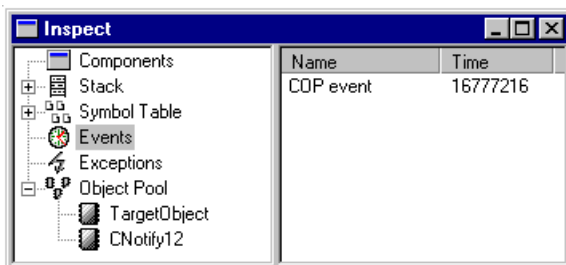

Events are only used in the HC(S)08 Freescale Full Chip Simulator. This information is used for simulation I/O device development.

When simulating a watchdog/COP, an event with the remaining time is displayed in the Event View.

Exceptions Icon

The Inspector window Exceptions icon shown in [Figure 3.82](#) shows all currently raised exceptions. Exceptions are pending interrupts.

Figure 3.82 Inspector Window Exceptions Icon

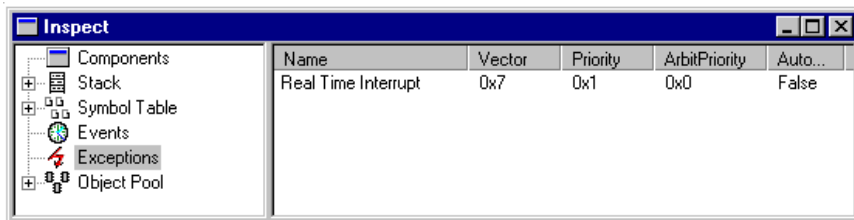

Events are only used in the HC(S)08 Freescale Full Chip Simulator. This information is used for simulation I/O device development.

Since interrupts are usually simulated immediately when they are raised, the Exceptions are usually empty. Only when interrupts are disabled or an interrupt is handled, something is visible in this item.

When simulating a watchdog/COP, an Exception is raised as soon as the watchdog time elapses.

Object Pool

The Object Pool shown in [Figure 3.83](#) is a pool of objects. It can contain any number of Objects, which can communicate together and also with other parts of the Debugger.

Figure 3.83 Inspector Window Object Pool

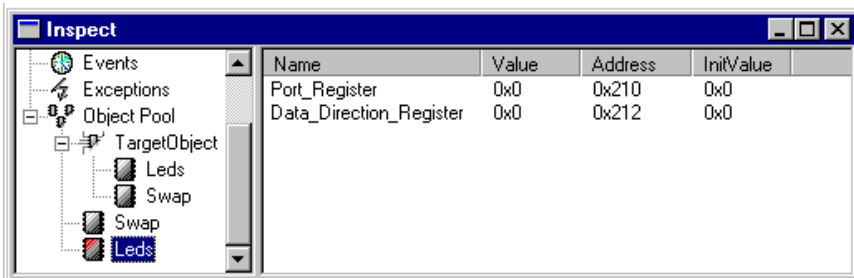

The most common use of Objects is to simulate special hardware with the I/O development package, however, other connections also use the Object Pool. For example, the Terminal Component exchanges its input and output by the Object Pool. The Terminal Component also operates with some hardware connections.

For the HC(S)08 Freescale Full Chip Simulator, the Object Pool usually contains the TargetObject, which represents the address space. All Objects that are loaded are displayed in the Object Pool. The TargetObject additionally shows the objects that are mapped to the address space.

IO Registers

The IO Registers icon shown in [Figure 3.84](#) shows all the IO Registers and Core Registers referenced by the debugger database. The Inspector can therefore provide many more registers information than the regular Register window.

Figure 3.84 Inspector Window IO Registers: ColdFire registers set example

Name	Value	AccessResult	Address or ID	Size	Access	Type
TPM3C5C	0x0	OK	0xffff8060	0x8	RW	Memory Mapped Reg
TPM3C5B	0x0	OK	0xffff8061	0x10	RW	Memory Mapped Reg
TPM3MOD	0x0	OK	0xffff8063	0x10	RW	Memory Mapped Reg
TPM3C05C	0x0	OK	0xffff8065	0x8	RW	Memory Mapped Reg
TPM3C0V	0x0	OK	0xffff8066	0x10	RW	Memory Mapped Reg
TPM3C15C	0x0	OK	0xffff8068	0x8	RW	Memory Mapped Reg
TPM3C1V	0x0	OK	0xffff8069	0x10	RW	Memory Mapped Reg
TPM3C25C	0x0	OK	0xffff806b	0x8	RW	Memory Mapped Reg
TPM3C2V	0x0	OK	0xffff806c	0x10	RW	Memory Mapped Reg
TPM3C35C	0x0	OK	0xffff806e	0x8	RW	Memory Mapped Reg
TPM3C3V	0x0	OK	0xffff806f	0x10	RW	Memory Mapped Reg
TPM3C45C	0x0	OK	0xffff8071	0x8	RW	Memory Mapped Reg
TPM3C4V	0x0	OK	0xffff8072	0x10	RW	Memory Mapped Reg
TPM3C55C	0x0	OK	0xffff8074	0x8	RW	Memory Mapped Reg
TPM3C5V	0x0	OK	0xffff8075	0x10	RW	Memory Mapped Reg

Each group of registers can be expanded, and registers can be directly edited in the Value column when double-clicking directly on the value. Register names are provided in the Name column, an access result diagnostic is given in the AccessResult column, the register size is given in bits in the size column, the kind of access (read, read/write, write) is given in the Access column, and finally the Type column indicates if the register is memory mapped or is a special purpose register (core).

Inspector Operations

Click the folded/unfolded icons to unfold/fold the tree and display/hide additional information.

Click on any icon or name to see the corresponding information displayed on the right side.

On the right side, some value fields can be edited by double clicking on them. Only values that are accessible can be edited. Usually, if a value is displayed, it can be changed. I/O Devices in the Object Pool do not accept all new values, depending on the I/O Device.

Debugger Components

Visualization Utilities

Values can be entered in hexadecimal (with preceding **0x**), in decimal, in octal (with preceding **0**), or in binary (with preceding **&**).

To see the IO_Led in the Inspector, as shown in [Figure 3.85](#), open the IO_Led with the context menu **Component-Open** and then open the Inspector. If the Inspector is already loaded, select **Update** from the context menu in the Inspector. Then click on the Components icon to see the Component list, which now includes the “IO_Led” component.

Figure 3.85 How to See the IO_Led in the Inspector Window

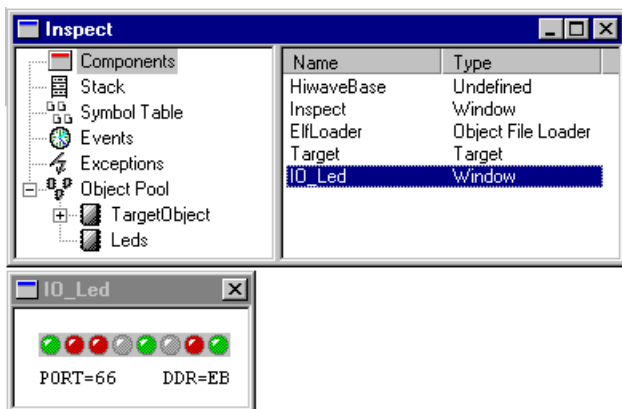

Expand Object Pool, to see the Leds icon. Click on the Leds icon. On the right side, the Port_Register and Data_Direction_Register are displayed with their current value. Double click on the values to change them ([Figure 3.86](#)).

Figure 3.86 Changing Data_Direction_Register Value

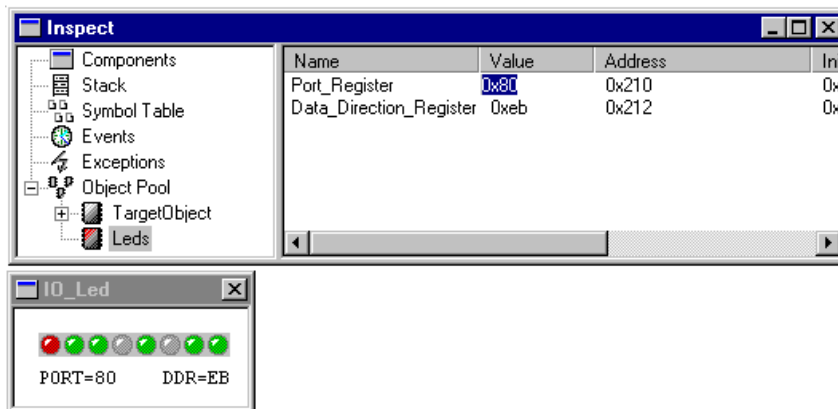

Inspector Menu

The Inspector menu contains entries described in [Table 3.40](#).

Table 3.40 Inspector Menu Entries

Menu Entry	Description
Update	All displayed information is updated Items that no longer exist are removed and new items are added.

Associated Context Menu

Commands in the Inspector context menu depend on the selected item. It can contain entries described in [Table 3.41](#).

Table 3.41 Inspector Context Menu Entries Description

Menu Entry	Context	Description
Update	All items	All displayed information is updated Items that no longer exist are removed and new items are added.
Max. Elements	All items	To display large arrays element by element, the maximum number can be configured. It is also possible to display a dialog box that prompts the user.
Format	All items	Numerical values can be displayed in different formats.
Close	single selected Component only	Closes the corresponding component

Drag Out

Items that can be dragged, depends on which icon is selected. [Table 3.42](#) gives a brief description.

Table 3.42 Inspector Component Drag Possibilities

Dragging Item	Description
Components	The components cannot be dragged
Stack	The Stack Icon itself cannot be dragged. All subitems can be dragged the same way as the Symbol Table subitems, described below.
Symbol Table	The Symbol Table icon cannot be dragged out. Subitems can be dragged depending on their type: <ul style="list-style-type: none"> • Modules: Modules can be dragged to the source and global data window to specify a specific module. • Functions: Functions can be dragged to display the function or code range. • Variables: Variables can be dragged to display their content in memory. • Indirections: Indirections can be dragged to display their content in memory.

Drop Into

Nothing can be dropped in.

Demo Version Limitations

Only 5 items can be expanded at each location. For remaining items, an icon with the text **Demo Limitation** is displayed, as shown in [Figure 3.87](#).

Figure 3.87 Inspector Component Demo Version Limitations

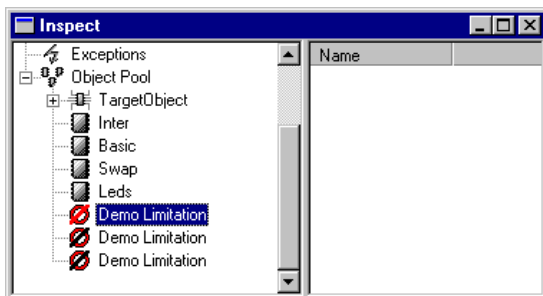

Visualization Tool Component

The Visualization Tool component is a very convenient tool for presenting your data. For software demonstration, or for your own debugging session, take advantage of all its virtual instruments.

The VisualizationTool window, shown in [Figure 3.88](#), consists of a plain workspace that can be equipped with many different instruments.

Figure 3.88 VisualizationTool Window

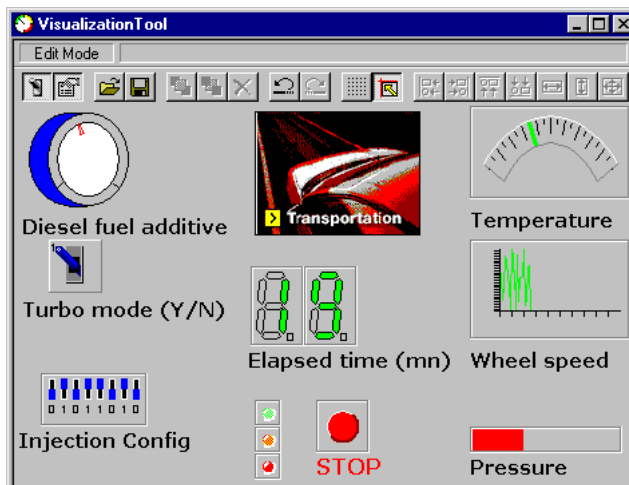

Edit Mode and Display Mode

The VisualizationTool may operate in two modes: Display mode or Edit mode.

The Edit mode is for designing the workspace to suit your needs. In the Display mode you can then use what you have done in the Edit mode, that is, to view values, interact with your application and instruments, press buttons, etc.

To switch between these two modes, you can use the toolbar, the context menu, or the shortcut **Ctrl+E**.

Add New Instrument

Use the context menu ([VisualizationTool Menu](#)) to add a new instrument.

Instrument Selection

You can select a single instrument by left clicking the mouse on it, and change the selection by pressing the tab-key.

To make multiple selections, hold down the control key and left-click on the desired instruments. You can also left click, hold and move to create a selection rectangle.

Move Instruments

There are two ways to move instruments. First, make your desired selection. You can then use the mouse to drag the instruments, or use the cursor keys to move them step by step (hold down the control key to move the instrument in steps of ten). The move process performed with the mouse can be broken off by pressing the escape key.

Resize Instruments

When you select a instrument, sizing handles appear at the corners and along the edges of the selection rectangle. You can resize an object by dragging its sizing handles, or by using the cursor keys while holding down the shift key. The resize process performed with the mouse can be broken off by pressing the escape key. Only one instrument can be resized at a time. Furthermore, each instruments has its own size minimum.

VisualizationTool Menu

Once the Visualization Tool component has been launched, its menu appears in the debugger menu bar. The menu contains the entries described in [Table 3.43](#).

Table 3.43 Visualization Tool Menu Description

Menu Entry	Description
Properties	Displays the properties of the currently selected instrument. Shortcut: <Ctrl+P>
Add New Instrument	Enables to choose an instrument from the list and add it to the view.
Paste	Pastes an instrument that has been previously copied. Shortcut: <Ctrl+V>
Select All	Selects all the instruments of the view. Shortcut: <Ctrl+A>
Edit mode	Switches between Display mode and Edit mode. In Edit mode, this entry is checked. Shortcut: <Ctrl+E>

Table 3.43 Visualization Tool Menu Description (continued)

Menu Entry	Description
Load Layout	Loads a VisualizationTool-Layout (*.vtl). Does not remove the actual instruments. Shortcut: <Ctrl+L>
Save Layout	Saves the current layout to a file (*.vtl). Shortcut: <Ctrl+S>

Associated Context Menu

The context menu of the VisualizationTool depends on the current selection. It can contain the entries described in [Table 3.44](#).

Table 3.44 VisualizationTool Context Menu

Menu entry	Context	Description
Edit mode	Always	Switches between Display mode and Edit mode. In Edit mode, this entry is checked.
Setup	Always	Shows Setup dialog box of the VisualizationTool.
Load Layout	Edit mode	Loads a VisualizationTool-Layout (*.vtl).
Save Layout	Always	Saves current layout to a file (*.vtl).
Add New Instrument	Edit mode	Shows a new context menu with all available instruments.
Properties	Only one instrument selected	Shows property dialog box for the currently selected instrument. Shortcut: Ctrl + P
Remove	At least one selection	Removes all currently selected instruments. Shortcut: Delete
Copy	At least one selection	Copies data of the currently selected instruments into the clipboard. Shortcut: Ctrl + C
Cut	At least one selection	Cuts currently selected instruments into the clipboard. Shortcut: Ctrl + X

Table 3.44 VisualizationTool Context Menu (*continued*)

Menu entry	Context	Description
Paste	Edit mode	Adds instruments, which are temporary stored in the clipboard, to the workspace. Shortcut: Ctrl + V
Send to Back	At least one selection	Sends current instrument to the back of the Z-order.
Send to Front	At least one selection	Brings current instrument to the front of the Z-order.
Clone Attributes	More than one selection	Clones common attributes to all selected instruments according to the last selected. Shortcut: <Ctrl + Enter>
Align	At least two selections	Gives access to a new menu for alignment.
Top	Align	Aligns instruments to the top line of the last selected instrument.
Bottom	Align	Aligns instruments to the bottom line of the last selected instrument.
Left	Align	Aligns instruments to the left line of the last selected instrument.
Right	Align	Aligns instruments to the right line of the last selected instrument.
Size	Align	Makes size of all selected instruments the same as the last selected.
Vertical Size	Align	Makes vertical size of all selected instruments the same as the last selected.
Horizontal Size	Align	Makes horizontal size of all selected instruments the same as the last selected.

VisualizationTool Properties

Like other instruments, the VisualizationTool itself has Properties. There are several configuration possibilities for the VisualizationTool, shown in [Table 3.45](#). To view the property dialog box of the VisualizationTool, use the shortcut <CTRL-P> or double click on the background.

Table 3.45 VisualizationTool Properties

Menu Entry	Description
Edit mode	Switches from Edit mode to Display mode.
Display Scrollbars	Switches the scrollbars on, off, or sets it to automatic mode.
Display Headline	Switches the headline on or off.
Background color	Specifies the background color of the VisualizationTool.
Grid Mode	Specifies the grid mode. There are four possibilities: <i>Off</i> , <i>Show grid but no snap</i> , <i>Snap to grid without showing the grid</i> , or <i>Show the grid and snap on it</i> .
Grid Size	Specifies the distance between two grid points (vertical, horizontal).
Grid Color	Specifies the color of the grid points.
Refresh Mode	Specifies window refresh mode. You may choose between: Automatic, Periodical, Each access, CPU Cycles.

Instruments

When you first add an instrument, it is in “move mode”. Place it at the desired location on the workspace. All new instruments are set to their default attributes. To configure an instrument, right-click on an instrument and choose **Properties**, or double click on it. All instruments have the common attributes shown in [Table 3.46](#).

Table 3.46 Instruments Properties Attributes

Attribute	Description
X-Position	Specifies the X-coordinate of the upper left corner.
Y-Position	Specifies the Y-coordinate of the upper left corner.
Height	Specifies the instruments height.
Width	Specifies the instruments width.
Bounding Box	Specifies the look of the bounding box. Available displays are: No Box, Flat (outline only), Raised, Sunken, Etched, and Shadowed.
Background color	Defines the color of the instrument’s background. The checkbox enables to set a color or let the instrument be transparent.
Kind of Port	Specifies the kind of port to be used to get the value to display. The location must be specified in the Port to Display field.
Port to Display	Defines the location of the value be used for the instrument’s visualization. Here are some Examples: Substitute: <i>TargetObject.#210</i> Subscribe: <i>TargetObject.#210</i> Subscribe: <i>PORTB.PORTB (check exact spelling using Inspector)</i> Variable: <i>counter</i> Register: <i>SP</i> Memory: <i>0x210</i>
Size of Port	If you use the Memory Port, you can also specify the width of memory to display (up to 4 Bytes).

Analog Instrument

The Analog instrument ([Figure 3.89](#)) represents the classical pointer instrument, also known as speedometer or voltage meter.

Figure 3.89 Analog Instrument



Analog instrument attributes are shown in [Table 3.47](#).

Table 3.47 Analog Instrument Attributes

Attribute	Description
Low Display Value	Defines zero point of the indicator. Values below this definition are not displayed.
High Display Value	Defines highest position of the indicator. Defines the value at which the indicator reads 100%.
Indicatorlength	Defines length of the small indicator. Minimal value is set to 20.
Indicator	Defines color of the indicator. Default color is red.
Marks	Defines color of the marks. Default color is black.

Bar Instrument

Using the Bar instrument, values are displayed by a bar strip. This instrument (see [Figure 3.90](#)) may be used as a position state of a water tank.

Figure 3.90 Bar Instrument



Bar instrument attributes are shown in [Table 3.48](#)

Table 3.48 Bar Instrument Attributes

Attribute	Description
Low Display Value	Defines zero point of the indicator. Values below this definition are not displayed.
High Display Value	Defines highest position of the indicator. Defines the value on which the indicator reads 100%.
Barirection	Sets desired direction of the bar that displays the value.
Barcolor	Specifies color of the bar. Default color is red.

Bitmap Instrument

You can use the Bitmap instrument to give a special look to your visualization, or to display a warning picture.

Additionally, it can also be used as a bitmap animation. Its attributes are shown in [Table 3.49](#).

Table 3.49 Bitmap Instrument Attributes

Attribute	Description
Filename	Specifies the location of the bitmap. With the button behind, you can browse for files.
AND Mask	Performs a bitwise-AND operation with this value. AND the value of the selected port. Default value is 0.
EQUAL Mask	This value is compared to the result of the AND operation. The bitmap is displayed only if both values are the same. Default value is 0.

In general, for showing the bitmap, the following condition has to be true:

```
(port_memory & ANDmask) == EQUALmask
```

Following is a practical example about using the AND and EQUAL masks

You want to show in the visualization a tail light of a car. For this you need bitmaps (e.g. from a digital camera) of all possible states of the tail light (e.g. flasher on, brake light on, etc.). Usually the status of all lamps are encoded into a port or memory cell in your application, and each bit in this cell describes whether a lamp is on (e.g., bit 0 says that the

flasher is on, while bit 1 says that the brake light is on. So for your simple application you need the following bitmaps with their settings:

- No light on bitmap: AND mask 3, EQUAL mask 0
- Flasher on bitmap: AND mask 3, EQUAL mask 1
- Brake light on bitmap: AND mask 3, EQUAL mask 2
- Brake and flasher light on: AND mask 3, EQUAL mask 3

DILSwitch Instrument

The DILSwitch instrument is also known as Dual-in-Line Switch ([Figure 3.91](#)). It is mainly used for configuration purposes. You can use it for viewing or setting bits of one to four bytes.

Figure 3.91 DILSwitch Instrument



DILSwitch instrument attributes are listed in [Table 3.50](#).

Table 3.50 DILSwitch Instrument Attributes

Attribute	Description
Display 0/1	When enabled, displays the value of the bit under each plot of the DILSwitch instrument.
Switch Color	Specifies the color of the switch.

Knob Instrument

The Knob instrument is normally known as an adjustment instrument. For example, it can simulate the volume control of a radio ([Figure 3.92](#)).

Figure 3.92 Knob Instrument

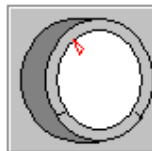

Knob instrument attributes are shown in [Table 3.51](#)

Table 3.51 Knob Instrument Attributes

Attribute	Description
Low Display Value	Defines the zero point of the indicator. The values below this definition are not displayed.
High Display Value	Defines the highest position of the indicator. It defines the value on which the indicator reads 100%.
Indicator Color	Defines the color and the width of the pen used to draw the indicator.
Knob Color	Defines the color of the knob side.

LED Instrument

The LED instrument is used for observing one definite bit of one byte ([Figure 3.93](#)). There are only two states: On and Off.

Figure 3.93 Led Instrument



LED instrument attributes are shown in [Table 3.52](#).

Table 3.52 LED Instrument Attributes

Attribute	Description
Bitnumber to Display	Defines the bit of the given byte to be displayed.
Color if Bit = = 1	Defines the color if the given bit is set.
Color if Bit = = 0	Defines the color if the given bit is not set.

7-Segment Display Instrument

This is the well known 7-Segment Display instrument for numbers and characters. It has seven segments and one point. These eight units represent eight bits of one byte ([Figure 3.94](#)).

Figure 3.94 7-Segment Display Instrument



7-Segment Display instrument attributes are shown in [Table 3.53](#)

Table 3.53 7-Segment Display Instrument Attributes

Attribute	Description
Decimalmode	Displays the first four or the second four bits of one byte in hexadecimal mode. When it is switched off, each segment represents one bit of one byte.
Sloping	Switches the sloping on or off.
Display Version	Selects the appearance of the instrument. Two versions are available.
Color if Bit = = 1	Defines the color of an activated segment. You may also set the color to transparent.
Color if Bit = = 0	Defines the color of a deactivated segment. You may also set the color to transparent.
Outlinecolor	Defines the color of the segment outlines. You may also set the color to transparent.

Switch Instrument

Use the Switch instrument to set or view a definite bit ([Figure 3.95](#)). The Switch instrument also provides an interesting debugging feature: you can let it simulate bounces, and thus check whether your algorithm is robust enough. Four different looks of the switch are available: slide switch, toggle switch, jumper or push button.

Figure 3.95 Switch Instrument



Switch instrument attributes are shown in [Table 3.54](#).

Table 3.54 Switch Instrument Attributes

Attribute	Description
Bitnumber to Display	Specifies the number of the bit you want to display.
Display 0/1	Enables ability to display the value of the bit in its upper left corner.

Table 3.54 Switch Instrument Attributes (*continued*)

Attribute	Description
Top Position is	Specifies if the 'up' position is either zero or one. Especially useful to easily transform the push button into a reset button.
Kind of Switch	Changes the look of the instrument. Following kinds of switches are available: Slide Switch, Toggle Switch, Jumper, Push Button. The behavior of the Push Button slightly differs from the others, since it returns to its initial state as soon as it has been released.
Switch Color	Specifies the color of the switch.
Bounces	If enabled, gives access to the following other attributes to configure the way the switch bounces.
Nb Bounces	Specifies the number of bounces before stabilization.
Bounces on Edge	Specifies whether the switch bounces on falling, rising or both edges.
Type of Unit	Synchronizes the frequency of the bouncing either on the timer of your host machine, or on CPU cycles.
Pulse Width (100ms)	Defines the duration of one bounce. Fill in this attribute if you chose "Host Periodical" in the "Type of Unit" attribute.
CPU Count	This attribute represents the number of CPU cycles to reach before the switch changes its state. Fill in this attribute if you chose "CPU Cycles" in the "Type of Unit" attribute.

Text Instrument

The Text instrument has several functions: Static Text, Value, Relative Value, and Command ([Figure 3.96](#)).

Figure 3.96 Text Instrument

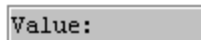

Use **Text Mode** to switch between the five available modes. Text instrument common attributes are shown in the [Table 3.55](#)

Table 3.55 Text Instrument Attributes

Attribute	Description
Text Mode	Specifies the mode. Choose among four modes: Static Text, Value, Relative Value, and Command
Displayfont	Defines the desired font. All installed Windows fonts are available.
Horiz. Text Alignment	Specifies the desired horizontal alignment of the text in the given bounding box.
Vert. Text Alignment	Specifies the desired vertical alignment of the text in the given bounding box.
Textcolor	Defines the color of the given text.

Static Text is used for adding descriptions on the workspace. Its attributes are shown in [Table 3.56](#).

Table 3.56 Static Text Attributes

Attribute	Description
Field Description	Contains the text to be displayed.

Value is used for displaying a value in different ways (decimal, hexadecimal, octal, or binary). Its attributes are shown in [Table 3.57](#).

Table 3.57 Value Attributes

Attribute	Description
Field Description	Contains the additional description that appears in front of the value. Add a colon and/or space as you wish. The default setting is Value:
Format mode	Defines the format. Choose among this list: Decimal, Hexadecimal, Octal, and Binary formats.

Relative Value is used for showing a value in a range of 0 up to 100% or 1000%. Its attributes are shown in [Table 3.58](#)

Table 3.58 Relative Value Attributes

Attribute	Description
Field Description	Add the additional description text to be displayed in front of the value. Add a colon and/or space if desired. The default setting is Value:
Low Display Value	Fixes the minimal value that represents 0%. Values below this definition appear as an error: #ERROR.
High Display Value	Fixes the maximal value that represent 100%. Values above this definition appear as an error: #ERROR.
Relative Mode	Switches between percent and permill.

Command: Use this instrument mode to specify a command to execute by clicking on this field. For more information about commands, read [Debugger Engine Commands](#). [Table 3.59](#) shows **Command** mode attributes.

Table 3.59 Command Attributes

Attribute	Description
Field Description	Contains the text that appears on the button.
Command	Contains the command-line command to execute after pressing the button.

CMD Callback mode is the same as **Command**, but with one difference: The returned value appears as text instead of **Field Description**. [Table 3.60](#) shows **CMD Callback** mode attributes.

Table 3.60 CMD Callback Attributes

Attribute	Description
Field Description	Warning: Executing the specified command overwrites the text in this field.
Command	Contains the command line command to execute after pressing the button.

Drop Into

In Edit mode, the drag and drop functionality supplies a very easy way to automatically configure an instrument.

To assign a variable, simply drag it from the Data Window onto the instrument.

The **kind of Port** is immediately set on “Memory” and the “Port to Display” field contains the address of the variable. Now repeat the drag-and-drop on a bare portion of the VisualizationTool window: a new text instrument is created, with correct port configuration.

Some other components allow this operation:

- The memory window: select bytes and drag-and-drop them onto the instrument.
- The Inspector component: pick an object from the object pool.

Demo Version Limitations

Loads only one VisualizationTool window. Limits the number of instruments to three.



Debugger Components
Visualization Utilities

Control Points

This chapter provides an overview of the debugger control points: Breakpoints, Watchpoints, and Markpoints. Click any of the following links to jump to the corresponding section of this chapter:

- [Introduction](#)
- [Breakpoints](#)
- [Setting Breakpoints](#)
- [Watchpoints](#)
- [Setting Watchpoints](#)
- [Markpoints](#)
- [Setting Markpoints](#)
- [Halting on a Control Point](#)

Introduction

There are three kinds of control points:

- Breakpoints (also called data breakpoints): Breakpoints are located at an address. They can be temporary or permanent.
- Watchpoints: Watchpoints are located at a memory range. They start from an address, have a range, and a read and/or write state.
- Markpoints: Are marked points of observation that can be jumped to by the programmer. They can be located in data, source or memory.

In the context menu of the Source, Memory or Assembly window you can set or disable a control point, set a condition and an optional command, and set the current count and counting interval.

You can edit control point characteristics in the three tabs of the Control Points Configuration Window: Breakpoints, Watchpoints and Markpoints tab. These three tabs have common properties that allow you to perform the following operations on control points:

- Select a single control point from a list box and click **Delete**.
- Select multiple control points from a list box and click **Delete**.

Control Points

Breakpoints

- Enable/disable a selected control point by checking or unchecking the related checkbox.
- Enable/disable multiple control points by checking or unchecking the related checkbox.
- Enter or modify the condition of a selected control point.
- Enable/disable the condition of a selected control point by checking/unchecking the related checkbox.
- Enter or modify the command of a selected control point.
- Enable/disable the command of a selected control point by checking/unchecking the related checkbox.
- Enable/disable multiple control point commands by selecting control points and checking/unchecking the related checkbox.
- Modify the counter and/or limit of a single control point.

With breakpoints, the following operations are also available:

- Enable/disable halting on a single temporary breakpoint by checking/unchecking the matching checkbox.
- Enable/disable halting on multiple temporary breakpoints by checking/unchecking the matching checkbox.

With watchpoints, the following operations are also available:

- Enable/disable halting on a single read and/or write access by checking/unchecking the corresponding checkboxes.
- Enable/disable halting on multiple read and/or write accesses by checking/unchecking the corresponding checkboxes.
- Define the memory range controlled by the watchpoint.

Breakpoints

Breakpoints are control points associated with a PC value. That is, program execution is stopped as soon as the PC reaches the value defined in a breakpoint. The debugger supports four different types of breakpoints:

- Temporary breakpoints, which are activated next time the instruction is executed.
- Permanent breakpoints, which are activated each time the instruction is executed.
- Counting breakpoints, which are activated after the instruction has been executed a certain number of times.
- Conditional breakpoints, which are activated when a given condition is TRUE.

Breakpoints are controlled through the Breakpoints tab of the Controlpoints Configuration window. This window can be opened through the Source Window Context menu, as described below:

Figure 4.1 Source Window Context Menu

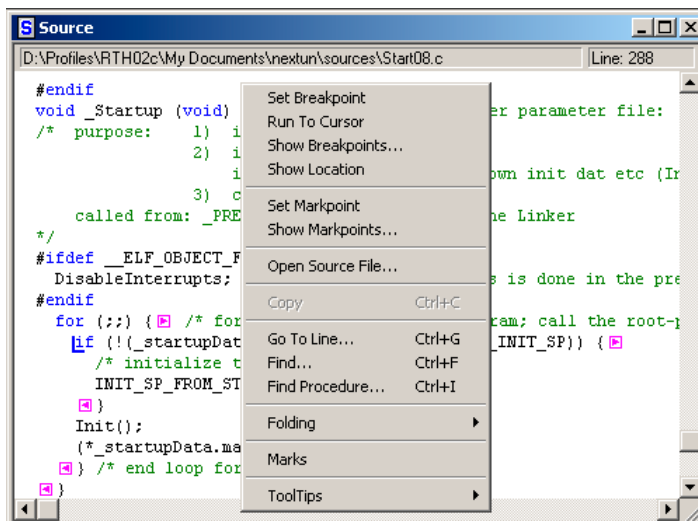

1. Point at a C statement in the Source window, and click the right mouse button.
2. Select **Show Breakpoints** from this menu.

The [Controlpoints Configuration Window \(Breakpoints Tab\)](#) is opened. The Breakpoints tab of this window is shown in [Figure 4.2](#).

Control Points

Breakpoints

Figure 4.2 Controlpoints Configuration Window (Breakpoints Tab)

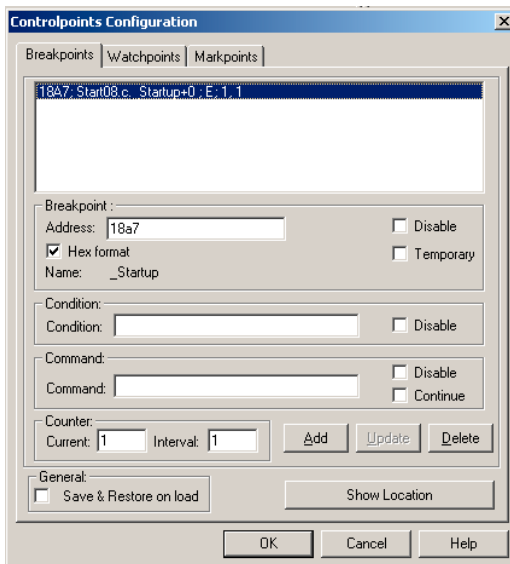

Breakpoints Tab

The [Controlpoints Configuration Window \(Breakpoints Tab\)](#) contains:

- List box that displays the list of currently defined breakpoints
- **Breakpoint:** group box that displays the address of the currently selected breakpoint, name of procedure in which the breakpoint has been set, state of the breakpoint (disabled or not), and type of breakpoint (temporary or permanent).
- **Condition:** group box that displays the condition string to evaluate, and the state of the condition (disabled or not).
- **Command:** group box that displays the command string to execute and the state of the command (disable or continue after command execution).
- **Counter:** group box that displays the current value of the counter and interval value of the counter.

NOTE Current and Interval values are limited to 2,147,483,647. If entering a number greater than this value, a beep occurs and the character is not appended. When the Interval value is changed, the Counter value is automatically set to the Interval value.

- **Delete** button to remove the currently selected breakpoint.

- **Update** button to Update all modifications in the dialog box.
- **Add** button to add new breakpoints. Specify the Address (in hexadecimal when **Hex format** is checked, or as an expression when **Hex format** is unchecked).
- **OK** button to validate all modifications.
- **Cancel** button to ignore all modifications.
- **Help** button to open related help information.

Multiple Selections in List Box

The list box allows you to select multiple consecutive breakpoints by clicking the first breakpoint then pressing the **Shift** key and clicking the last breakpoint you want to select.

The list box allows you to select multiple breakpoints that are not consecutive by clicking the first breakpoint then pressing the **Ctrl** key and clicking another breakpoint.

When multiple breakpoints are selected in the list box, the name of the group box **Breakpoint:** is changed to **Selected Breakpoints:**.

When selecting multiple breakpoints, the **Address** (hex), **Name**, **Condition**, **Disable** for condition, **Command**, **Current**, and **Interval** controls are disabled.

When multiple breakpoints are selected, the **Disable** and **Temporary** controls in the **Selected breakpoints:** group box are enabled and **Disable** in the **Command:** group box is enabled.

Checking Expressions

You can enter an expression in the **Condition:** group edit box. The syntax of the expression is checked when you select another breakpoint in the list box or click **OK**. The syntax is **parameters = = expression**. For a register condition the syntax is **\$RegisterName = = expression**.

If a syntax error has been detected, a message box is displayed:

```
Incorrect Condition. Do you want to correct it?.
```

If you click **OK**, correct the error in the condition edit box.

If you click **Cancel**, the **Condition:** edit box is cleared.

Saving Breakpoints

The Debugger provides a way to store all defined breakpoints of the currently loaded application (.ABS file) into the matching breakpoints file. The matching file has the same name as the loaded .ABS file but its extension is .BPT (for example, the FIBO.ABS file has a breakpoint file called FIBO.BPT). This file is generated in the same directory as the .ABS file. This is a text file, in which a sequence of commands is stored. This file contains the following information.

- The **Save & Restore on load** flag (**Save & Restore on load** checkbox in the [Controlpoints Configuration Window \(Breakpoints Tab\)](#)). The **SAVEBP** command is used: **SAVEBP on** when checked, **SAVEBP off** when unchecked.

NOTE For more information about this, see the [SAVEBP](#) command.

- List of defined breakpoints: the **BS** command is used, as shown in [Listing 4.1](#).

Listing 4.1 Breakpoint (.BPT) File Syntax

```
BS address [P|T[ state]][;cond="condition"[ state]]
[;cmd="command"[ state]][;cur=current[ inter=interval]]
[;cdSz=codeSize[ srSz=sourceSize]]
```

In the code above:

The **address** value is the address where the breakpoint is to be set. This address is specified in ANSI C format. The **address** value can also be replaced by an **expression** as shown in the example below.

P specifies the breakpoint as a permanent breakpoint.

T specifies the breakpoint as a temporary breakpoint. A temporary breakpoint is deleted once it is reached.

The state is **E**, **D** or **C** where **E** is for enabled (state is set by default to **E** if nothing is specified), **D** is for disabled and **C** for Continue.

The **condition** is an **expression**. It matches the **Condition** field in the [Controlpoints Configuration Window \(Breakpoints Tab\)](#) for conditional breakpoint.

The **command** is any debugger command. It matches the **Command** field in the [Controlpoints Configuration Window \(Breakpoints Tab\)](#), for associated commands.

The **current** value is an **expression**. It matches the **Current** field (**Counter**) in the [Controlpoints Configuration Window \(Breakpoints Tab\)](#), for counting breakpoints.

The **interval** is an **expression**. It matches the **Interval** field (**Counter**) in the [Controlpoints Configuration Window \(Breakpoints Tab\)](#), for counting breakpoints.

The **codeSize** value is an **expression**. It is usually a constant number to specify (for security) the code size of a function where a breakpoint is set. If the size specified does not match the size of the function currently loaded in the **.ABS** file, the breakpoint is set but it is disabled.

The **sourceSize** value is an **expression**. It is usually a constant number to specify (for security) the source (text) size of a function where a breakpoint is set. If the size specified does not match the size of the function in the source file, the breakpoint is set but it is disabled.

- If **Save & Restore on load** is checked and the user quits the debugger or loads another **.ABS** file, all breakpoints are saved.
- If **Save & Restore on load** is clear (default), only this flag (**SAVEBP off**) is saved.

Breakpoint File (.BPT) Example

Case 1: If **FIBO.ABS** is loaded, and **Save & Restore on load** was checked in a previous session of the same **.ABS** file, and breakpoints have been defined, the **FIBO.BPT** looks as shown in [Listing 4.2](#).

Listing 4.2 Breakpoint File with Save & Restore on load Checked

```
savebp on
BS &fibonacci:Fibonacci+19 P E; cond = "fibonacci > 10" E; cdSz = 47 srSz = 0
BS &fibonacci:Fibonacci+31 P E; cdSz = 47 srSz = 0
BS &fibonacci:main+12 P E; cdSz = 42 srSz = 0
BS &fibonacci:main+21 P E; cond = "fibonacciCount==5" E; cmd = "Assembly < spc
0x800" E; cdSz = 42 srSz = 0
```

Case 2: If **FIBO.ABS** is loaded, and **Save & Restore on load** was unchecked in a previous session of the same **.ABS** file and breakpoints have been defined, the **FIBO.BPT** looks as shown below:

```
savebp on
```

Only the flag has been saved and breakpoints have been removed.

NOTE If only one or few functions differ after a recompile, not all breakpoints are lost. Breakpoints are disabled only if the size of a function changes. The size of a function is evaluated in bytes (when it is compiled) and in characters (number of characters contained in the function source text). When an **.ABS** file is loaded and the matching **.BPT** file exists, for each **BS** command, the debugger checks if the code size (in bytes) and the source size (in characters) are different in the matching function (given by the symbol table). If there is a difference, the debugger sets and disables the breakpoint. If there is no difference, the debugger sets and enables the breakpoint.

NOTE For more information about this syntax, see [BS](#) and [SAVEBP](#) commands.

Setting Breakpoints

Breakpoints may be set in a Source or Assembly component window.

Positions Where a Breakpoint Is Definable

A compound statement is one that can be split into several base instructions. When using a high level language some compound statements can be generated, as shown in the following example.

Figure 4.3 Source and Assembly Windows

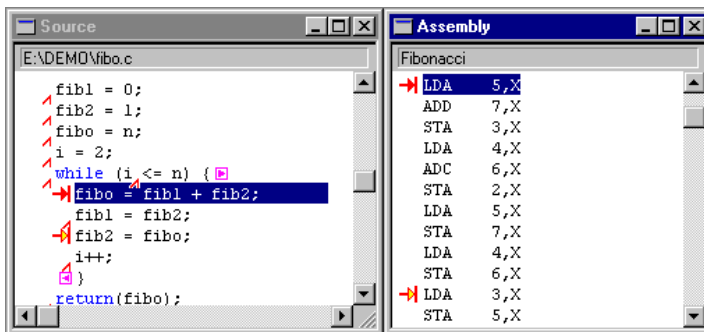

The debugger helps you detect all positions where you can set a breakpoint.

1. Right-click in the Source component. The Source Context Menu is displayed on the screen.
2. Choose **Marks** from the Context Menu. All statements where a breakpoint can be set are identified by a special red inverted check mark:



To remove the breakpoint marks, right-click in the Source component and choose **Marks** again.

Temporary Breakpoints

Temporary breakpoints are activated next time the instruction is executed. A temporary breakpoint is recognized by the following icon:



Setting Temporary Breakpoints

Using the Source Window Context Menu:

1. Point at a C statement in the Source window and right-click. The Source Context Menu is displayed.
2. Choose **Run To Cursor** from the Context Menu. The application continues execution and stops before executing the statement. A temporary breakpoint is set.

Holding down the left mouse button and pressing the T key:

1. Point at a C statement in the Source window, hold down the left mouse button and press the T key.
2. A temporary breakpoint is defined.
3. Choose **Run To Cursor** from the Context Menu. The application continues execution and stops before executing the statement.

Temporary breakpoints are automatically deleted once they have been activated. If you continue program execution, it no longer stops on the statement that contained the temporary breakpoint.

Permanent Breakpoints

Permanent breakpoints are activated each time the instruction is executed. A permanent breakpoint is recognized by the following icon:



Setting Permanent Breakpoints

Using the Source Window Context Menu:

1. Point at a C statement in the Source window and right-click. The Source Context Menu is displayed.
2. Select **Set BreakPoint** from the Context Menu. A permanent breakpoint mark is displayed in front of the selected statement.

Control Points

Setting Breakpoints

Holding down the left mouse button and pressing the P key:

1. Point at a C statement in the Source window, hold down the left mouse button and press the P key.
2. A permanent breakpoint mark is displayed in front of the selected statement.

Once a permanent breakpoint has been defined, you can continue program execution. The application stops before executing the statement. Permanent breakpoints remain active until they are disabled or deleted.

Counting Breakpoints

Counting breakpoints are activated after the instruction has been executed a certain number of times. A Counting breakpoint is recognized by the following icon:



Setting Counting Breakpoints

Counting breakpoints can only be set using the [Controlpoints Configuration Window \(Breakpoints Tab\)](#). There are two ways to set a counting breakpoint:

Holding down the left mouse button and pressing the S key:

1. Point at a C statement in the Source window, hold down the left mouse button and press the S key.
2. The Controlpoints Configuration window with the Breakpoints tab is opened.
3. A new breakpoint is inserted in the list of breakpoints defined in the application.
4. Select the breakpoint you want to modify by clicking on the corresponding entry in the list of defined breakpoints at the top of the tab.
5. In the **Counter:** group of this tab specify the interval for the breakpoint detection in the **Interval:** field.
6. Then close the window by clicking the **OK** button.

Using the Source Context Menu:

1. Point at a C statement in the Source window and right-click. The Source Context Menu is displayed.
2. Choose **Set BreakPoint** from the Context Menu. A breakpoint is defined on the selected instruction.
3. Point in the Source window and right-click again.
4. Choose **Show Breakpoints** from the Context Menu. The [Controlpoints Configuration Window \(Breakpoints Tab\)](#) is displayed.

5. Select the breakpoint you want to modify by clicking on the corresponding entry in the list of defined breakpoints at the top of the tab.
6. In the **Counter:** group of this tab specify the interval for the breakpoint detection in the **Interval:** field.
7. Then close the window by clicking the **OK** button.

If you continue program execution, the content of the **Current:** field is decremented each time the instruction containing the breakpoint is reached. When **Current** is equal to 0, the application stops. If the checkbox **Temporary** is unchecked (not a temporary breakpoint), **Current** is reloaded with the value stored in **Interval:** in order to enable the counting breakpoint again.

Conditional Breakpoints

Conditional breakpoints are activated when a given condition is TRUE. A conditional breakpoint is recognized by the following icon:



Setting Conditional Breakpoints

Conditional breakpoints can only be set from the Controlpoint Configuration window's Breakpoints tab. There are two ways to set a conditional breakpoint:

Holding down the left mouse button and pressing the S key:

1. Point at a C statement in the Source Component window, hold down the left mouse button and press the S key.
2. The [Controlpoints Configuration Window \(Breakpoints Tab\)](#) is opened and a new breakpoint is inserted in the list of breakpoints defined in the application.
3. Select the breakpoint you want to modify by clicking on the corresponding entry in the list of defined breakpoints.
4. Specify the condition for breakpoint activation in the **Condition:** group Condition box. The condition must be specified using the ANSI C syntax (Example **counter == 7**). You can use register values in the breakpoint condition field with the following syntax: **\$RegisterName** (Example **\$RX == 0x10**)
5. Close the window by clicking **OK**.

Using the Source Window Context Menu:

1. Point at a C statement in the Source Component window and right-click. The Source Context Menu is displayed.
2. Select **Set BreakPoint** from the Context Menu. A breakpoint is defined on the selected instruction.
3. Point in the Source Component window and right-click. The Source Context Menu is displayed.
4. Select Show Breakpoints from the Context Menu. The [Controlpoints Configuration Window \(Breakpoints Tab\)](#) is opened and a new breakpoint is inserted in the list of breakpoints defined in the application.
5. Select the breakpoint you want to modify by clicking on the corresponding entry in the list of defined breakpoints.
6. Specify the condition for breakpoint activation in the **Condition:** group Condition box. The condition must be specified using the ANSI C syntax (Example `counter == 7`). You can use register values in the breakpoint condition field with the following syntax: **\$RegisterName** (Example `$RX == 0x10`)
7. Close the window by clicking **OK**.

If you continue program execution, the condition is evaluated each time the instruction containing the conditional breakpoint is reached. When the condition is **TRUE**, the application stops.

Deleting Breakpoints

The debugger provides three ways to delete a breakpoint:

Using Delete Breakpoint from Source Context Menu

1. In the Source component window, point at a C statement where a breakpoint has previously been defined and right-click. The Source Context Menu is displayed.
2. Choose **Delete Breakpoint** from the context menu. The breakpoint is deleted.

Holding down the left mouse button and pressing the D key:

1. Point at a C statement in the Source Component window where a breakpoint has previously been defined, hold down the left mouse button and press the D key.
2. The breakpoint is deleted.

Choosing Show Breakpoints from Source Context Menu

1. Point in the Source Component window and right-click. The Source Context Menu is displayed.
2. Choose **Show Breakpoints** from the context menu. The **Breakpoints Setting** dialog box is displayed.
3. In the list of defined breakpoints, select the breakpoint to delete.
4. Click **Delete**. The selected breakpoint is removed from the list of defined breakpoints.
5. Click **OK** to close the **Breakpoints Setting** dialog box.

The icon associated with the deleted breakpoint is removed from the source component.

Associate a Command with a Breakpoint

Each breakpoint (temporary, permanent, counting or conditional) can be associated with a debugger command. This command can be specified in the Breakpoints tab of the Controlpoints Configuration window. To open this window choose **Show Breakpoints** from the Source Window context menu.

In the Breakpoints tab of the Controlpoints Configuration window:

1. Select the breakpoint to modify by clicking on the corresponding entry in the list of defined breakpoints.
2. Enter the command in the **Command** field. The command is a single debugger command (at this level, the commands **G**, **GO** and **STOP** are not allowed). A command file can be associated with a breakpoint using the command **CALL** or **CF** (Example: `CF breakCmd.cmd`).
3. Click **OK** to close the window.

When the breakpoint is detected, the command is executed and the application stops.

The **Continue** check button of the Controlpoints Configuration window allows the application to continue after the command is executed.

Demo Version Limitations

Only two breakpoints can be set.

Watchpoints

Watchpoints are control points associated with a memory range. Program execution stops when the memory range defined by the watchpoint has been accessed. The debugger supports different types of watchpoints:

- Read Access Watchpoints, which are activated when a read access occurs inside the specified memory range.
- Write Access Watchpoints, which are activated when a write access occurs inside the specified memory range.
- Read/Write Access Watchpoints, activated when a read or write access occurs inside the specified memory range.
- Counting Watchpoints, activated after a specified number of accesses occur inside the memory range.
- Conditional Watchpoints, activated when an access occurs inside the memory range and a given condition is TRUE.

Watchpoints are controlled through the [Controlpoints Configuration Window \(Watchpoints Tab\)](#). This window can be opened through the Memory or Data component window context menu, as described below:

To open the Controlpoints Configuration window with the Watchpoints tab exposed:

1. Position your cursor in either the Memory or Data component window.
2. Press the right mouse button.
3. Select **Show Watchpoints** from either menu.
4. Click the left mouse button.

The ControlPoints Configuration window appears. The Watchpoints tab of this window is shown in [Figure 4.6](#).

Figure 4.4 Memory Context Menu

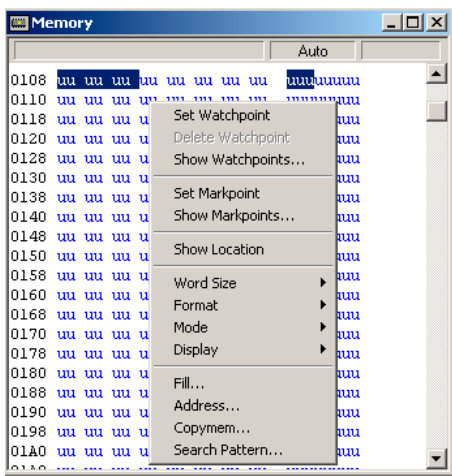
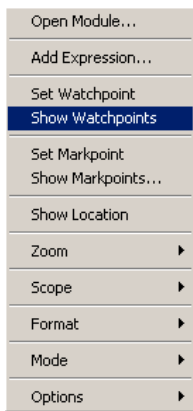

Figure 4.5 Data Context Menu



Control Points

Watchpoints

Figure 4.6 Controlpoints Configuration Window (Watchpoints Tab)

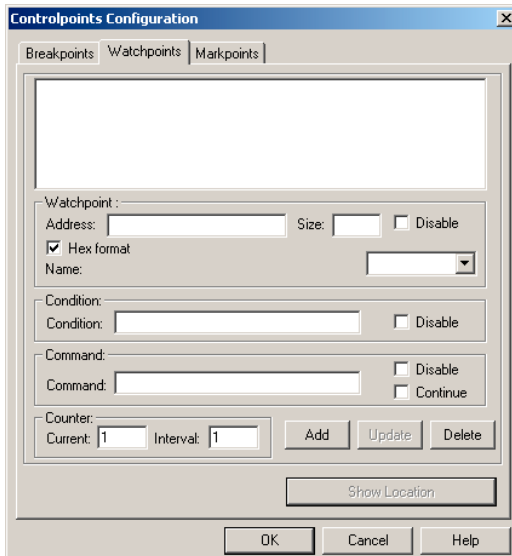

Watchpoints Tab

The Watchpoints tab of the Controlpoints Configuration window contains:

- List box that displays the list of currently defined watchpoints.
- **Watchpoint:** group box that displays the address of the currently selected watchpoint, size of the watchpoint, name of the procedure or variable on which the watchpoint has been set, state of the watchpoint (disabled or not), read access of the watchpoint (enabled or not) and write access of the watchpoint (enabled or not).
- **Condition:** group box that displays the condition string to evaluate and the state of the condition (disabled or not).
- **Update** button to Update all modifications in the dialog box.
- **Command:** group box that displays the command string to execute and state of the command (disabled or continue after command execution).
- **Delete** button to remove currently selected watchpoint and select the watchpoint that is below the removed watchpoint.
- **OK:** button to validate all modifications.
- **Add** button to add new watchpoints. Specify the Address in hexadecimal when **Hex format** is checked or as an expression when **Hex format** is unchecked.
- **Counter:** group box that displays the current value of the counter and interval value of the counter.

NOTE Current and Interval values are limited to 2,147,483,647. A beep occurs and the character is not appended, if a number greater than this value is entered.

NOTE When the Interval value is changed, the Counter value is automatically set to the Interval value.

- **Cancel** button to ignore all modifications.
- **Help:** button to display help file and related help information.

Multiple Selections

For watchpoints, you can do multiple selections in the Watchpoints tab of the Controlpoints Configuration window using the **Shift** and **Ctrl** keys.

When multiple watchpoints in the list box are selected, the name of the group box **Watchpoint:** is changed to **Selected Watchpoints:**.

When multiple watchpoints are selected, the **Address** (hex), **Size**, **Name**, **Condition**, **Disable** for condition, **Command**, **Current**, and **Interval** controls are disabled.

When multiple watchpoints are selected in the list box, the **Disable**, **Read** and **Write** controls in the **Selected watchpoints:** group box are enabled.

When multiple watchpoints are selected, **Disable** in the **Command:** group box is enabled.

Click **Delete** when multiple watchpoints are selected to remove watchpoints from the list box.

Checking Syntax

You can enter an expression in the Condition group edit box. Check the syntax of the expression by selecting another watchpoint in the list box or by clicking **OK**.

If a syntax error is detected, a message box appears:

```
Incorrect Condition. Do you want to correct it?
```

Click **OK** to correct the error in the condition edit box.

Click **Cancel** to clear the condition edit box.

Setting Watchpoints

Watchpoints may be set in a Data or Memory window.

NOTE Due to hardware restrictions, the watchpoint function might not be implemented on hardware connections.

Setting a Read Watchpoint

A green vertical bar is displayed in front of a variable associated with a read access watchpoint.

The debugger provides two ways to define a read access watchpoint:

Using the Data Context Menu:

1. Point at a variable in the Data window and right-click. The [Data Context Menu](#) is displayed.
2. Choose **Set Watchpoint** from the Context Menu. A **Read/Write** Watchpoint is defined.
3. Point in the Data window and right-click. The Data Context Menu is displayed.
4. Choose **Show WatchPoints** from the Context Menu. The Controlpoints Configuration window Watchpoints tab is displayed.
5. Select the watchpoint you want to define as *read* access from the list.
6. Select the **Read** type in the list menu.
7. A read access watchpoint is defined for the selected variable.

Using the Left Mouse Button and Pressing the R Key:

1. Point at a variable in the Data window, hold down the left mouse button and press the R key.
2. A read access watchpoint is defined for the selected variable.

Once a read access watchpoint has been defined, you can continue program execution. The application stops after detecting the next read access on the variable. Read access watchpoints remain active until they are disabled or deleted.

Setting a Write Watchpoint

A red vertical bar is displayed in front of a variable associated with a write access watchpoint.

The Debugger provides two ways to define a write access watchpoint:

Using the Data Context Menu:

1. Point at a variable in the Data window and right-click. The Data Context Menu is displayed.
2. Choose **Set Watchpoint** from the Context Menu. A Read/Write Watchpoint is defined.
3. Point in the Data Component Window and right-click. The Source Context Menu is displayed.
4. Choose **Show WatchPoints** from the Context Menu. The Controlpoints Configuration window Watchpoints tab is displayed.
5. Select the watchpoint you want to define as write access from the list.
6. Select the **Write** type in the list menu.
7. A write access watchpoint is defined for the selected variable.

Using the Left Mouse Button and Pressing the W Key:

1. Point at a variable in the Data window, hold down the left mouse button and press the W key.
2. A write access watchpoint is defined for the selected variable.

Once a write access watchpoint has been defined, you can continue program execution. The application stops after the next write access on the variable. Write access watchpoints remain active until they are disabled or deleted.

Defining a Read/Write Watchpoint

A yellow vertical bar is displayed in front of a variable associated with a read/write access watchpoint.

The debugger provides two ways to define a read/write access watchpoint:

Using the Data Context Menu:

1. Point at a variable in the Data window and right-click. The Data Context Menu is displayed.
2. Choose **Set Watchpoint** from the Context Menu. A Read/Write Watchpoint is defined.

Using the Left Mouse Button and Pressing the B Key:

1. Point at a variable in the Data window, hold down the left mouse button and press the B key.
2. A read/write access watchpoint is defined for the selected variable.

Once a read/write access watchpoint has been defined, you can continue program execution. The application stops after the next read or write access on the variable. Read/write access watchpoints remain active until they are disabled or deleted.

Defining a Counting Watchpoint

A counter can be associated with any type of watchpoint (read, write, read/write).

The Debugger provides two ways to define a counting watchpoint:

Using the Data Context Menu:

1. Point at a variable in the Data window and right-click. The Data Context Menu is displayed.
2. Choose **Set Watchpoint** from the Context Menu. A Read/Write Watchpoint is defined.
3. Point in the Data Component Window and right-click. The Source Context Menu is displayed.
4. Choose **Show WatchPoints** from the Context Menu. The Controlpoints Configuration window Watchpoints tab is displayed.
5. Select the watchpoint you want to define as a counting watchpoint.
6. From the list menu, select the type of access you want to track.
7. In the interval field, specify the interval count for the watchpoint.
8. Close the window by clicking **OK**. A counting watchpoint is defined for the selected variable.

Using the Left Mouse Button and Pressing the S Key:

1. Point at a variable in the Data window, hold down the left mouse button and press the S key. The Watchpoints tab of the Controlpoints Configuration window is displayed.
2. Select the watchpoint you want to define as a counting watchpoint from the list.
3. From the list menu, select the type of access you want to track.
4. In the interval field, specify the interval count for the watchpoint. Close the window by clicking **OK**. A counting watchpoint is defined for the selected variable.

If you continue program execution, the **Current** field is decremented each time an appropriate access on the variable is detected. When **Current** is equal to 0, the application

stops. **Current** is reloaded with the value stored in the interval field to enable the counting watchpoint again.

Defining a Conditional Watchpoint

A condition can be associated with any type of watchpoint described previously (read, write, read/write).

The Debugger provides two ways to define a conditional watchpoint:

Using the Data Context Menu:

1. Point at a variable in the Data window and right-click. The Data Context Menu is displayed.
2. Choose **Set Watchpoint** from the Context Menu. A Read/Write Watchpoint is defined.
3. Point in the Data window and right-click. The Source Context Menu is displayed.
4. Choose **Show WatchPoints** from the Context Menu. The Controlpoints Configuration window Watchpoints tab is displayed.
5. Select the watchpoint you want to define as a conditional watchpoint.
6. From the list menu, select the type of access you want to track.
7. Specify the condition for the watchpoint in the **Condition** field. The condition must be specified using the ANSI C syntax (Example: counter == 7).
8. Close the window by clicking **OK**. A conditional watchpoint is defined for the selected variable.

Using the Left Mouse Button and Pressing the S Key:

1. Point at a variable in the Data window, hold down the left mouse button and press the S key. The Watchpoints tab of the Controlpoints Configuration window is displayed.
2. Select the watchpoint you want to define as a conditional watchpoint.
3. From the list menu, select the type of access you want to track.
4. Specify the condition for watchpoint activation in the Condition field. The condition must be specified using the ANSI C syntax (Example: **counter == 7**). You can use register values in the breakpoint condition field with the following syntax: **\$RegisterName** (Example **\$RX == 0x10**)
5. Close the window by clicking **OK**. A conditional watchpoint is defined for the selected variable.

If you continue program execution, the condition is evaluated each time an appropriate access on the variable is detected. When the condition is TRUE, the application stops.

Deleting a Watchpoint

The Debugger provides three ways to delete a watchpoint:

Use Delete Breakpoint from Context Menu:

1. In the Data window, point to a variable where a watchpoint has been defined and right-click. The Data Context Menu is displayed.
2. Select **Delete Watchpoint** from the Context Menu. The watchpoint is deleted and the vertical bar in front of the variable is removed.

Using the Left Mouse Button and Pressing the D Key:

1. Point at a variable in the Data window, hold down the left mouse button and press the D key. The Watchpoints tab of the Controlpoints Configuration window is displayed.
2. The watchpoint is deleted and the vertical bar in front of the variable is removed.

Choosing Show Watchpoints from Data Context Menu:

1. Point in the Data window and right-click. The Data context menu is displayed.
2. Choose **Show Watchpoints** from the context menu. The Watchpoints tab of the Controlpoints Configuration window is displayed.
3. Select the watchpoint you want to delete.
4. Click **Delete**. The selected watchpoint is removed from the list of defined watchpoints.
5. Click **OK** to close the window. The watchpoint is deleted and the vertical bar in front of the variable is removed.

Associate a Command with a Watchpoint

Each watchpoint type (read, write, read/write, counting, or conditional) can be associated with a debugger command. This command can be specified in the Watchpoints tab of the Controlpoints Configuration window. To open this window:

Choosing Show Watchpoints from Data Context Menu:

1. Point in the Data Component Window and right-click. The [Data Context Menu](#) is displayed.
2. Select **Show Watchpoints** from the Context Menu. The Watchpoints tab of the Controlpoints Configuration window is displayed.
3. Click on the corresponding entry in the list of defined breakpoints to select the watchpoint you want to modify.

4. You can enter the command in the **Command** field. The command is a single debugger command. At this level, the commands [G](#), [GO](#) and [STOP](#) are not allowed. A command file can be associated with a watchpoint using the commands [CALL](#) or [CF](#) (Example CF breakCmd.cmd).
5. Click **OK** to close the window.
6. When the watchpoint is detected, the command execute and the application stops at this point. The **Continue** check button allows the application to continue after command execution.

Demo Version Limitations

Only two watchpoints can be set.

Markpoints

Watchpoints are control points associated with a source line, memory or data range. They provide the programmer with accessible program markers.

Program execution does NOT stop when the Source line, data or memory range defined by the markpoint has been accessed.

Markpoints are controlled through the Markpoint tab of the [Controlpoints Configuration Window \(Markpoints Tab\)](#). This window can be opened through the Source, Memory or Data window context menu, as described below:

To open the Controlpoints Configuration window with the Markpoints tab displayed:

1. Position your cursor in either the Source, Memory or Data window.
2. Press the right mouse button.
3. Select **Show Watchpoints** from the window's context menu.
4. Click the left mouse button.

The ControlPoints Configuration window appears with the Markpoints tab of this window displayed.

Control Points

Markpoints

Figure 4.7 Source Window Context Menu

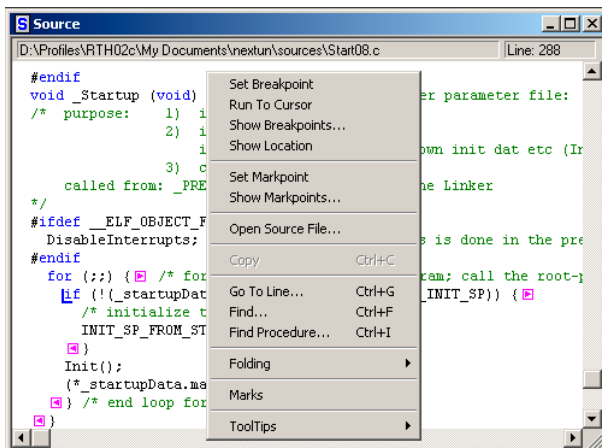

Figure 4.8 Memory Context Menu

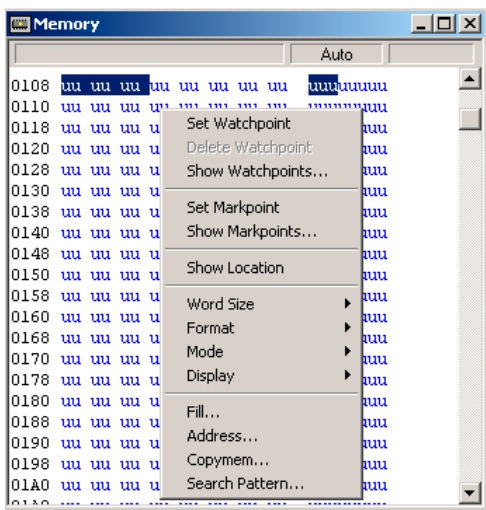
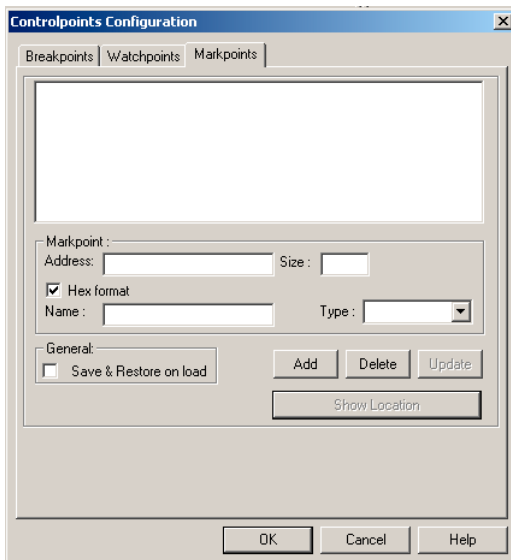

Figure 4.9 Data Context Menu



Figure 4.10 Controlpoints Configuration Window (Markpoints Tab)



Markpoints Tab

The Markpoints tab of the Controlpoints Configuration window contains:

- List box that displays the list of currently defined markpoints.

Control Points

Setting Markpoints

- **Markpoint:** group box that displays the address of the currently selected markpoint, size of the markpoint, name of the procedure or variable on which the markpoint has been set, and type of the markpoint.
- **General** group box that contains a checkbox that allows you to save and restore the markpoint selected.
- **Add** button to add new markpoints. Specify the Address in hexadecimal when **Hex format** is checked or as an expression when **Hex format** is unchecked.
- **Delete** button to remove currently selected markpoint and select the markpoint that is below the removed markpoint.
- **Update** button to update all modifications in the window.
- **OK:** button to validate all modifications.
- **Cancel** button to ignore all modifications.
- **Help:** button to display help file and related help information.

Setting Markpoints

Markpoints may be set in a Source, Data or Memory window.

Setting a Source Markpoint

A blue letter L is displayed in front of a code line associated with a markpoint. To define a markpoint in source code:

Use the Source Context Menu:

1. Point at a code line in the Source window and right-click. The [Source Window Context Menu](#) is displayed.
2. Choose **Set Markpoint** from the Context Menu. A **markpoint** is defined at the beginning of the line.
3. Point in the Source window and right-click. The Source Context Menu is displayed.
4. Choose **Show WatchPoints** from the context menu. The Controlpoints Configuration Window Markpoints Tab is displayed.
5. Make any modifications to the markpoint you have installed, or any other markpoints listed.
6. Click OK to close the window.

Setting a Data Markpoint

A blue letter L is displayed in front of a variable associated with a markpoint. To define a data range markpoint:

Use the Data Context Menu:

1. Point at a variable in the Data window and right-click. The [Data Context Menu](#) is displayed.
2. Choose **Set Markpoint** from the context menu. A markpoint is defined at the beginning of the data range selected.
3. Point in the Data window and right-click. The Data Context Menu is displayed.
4. Choose **Show WatchPoints** from the context menu. The Controlpoints Configuration Window Markpoints Tab is displayed.
5. Make any modifications to the markpoint you have installed, or any other markpoints listed.
6. Click OK to close the window.

Setting a Memory Markpoint

A blue letter L is displayed in front of a memory range associated with a markpoint. To define a Memory markpoint:

Use the Memory Context Menu:

1. Point at a line in the Memory window and right-click. The [Memory Context Menu](#) is displayed.
2. Choose **Set Watchpoint** from the Context Menu. A Markpoint is defined.
3. Point in the Memory window and right-click. The Memory Context Menu is displayed.
4. Choose **Show WatchPoints** from the Context Menu. The Controlpoints Configuration Window Markpoints Tab is displayed.
5. Make any modifications to the markpoint you have installed, or any other markpoints listed.
6. Click OK to close the window.

Control Points

Halting on a Control Point

Deleting a Markpoint

To delete a markpoint:

Using the Left Mouse Button and Pressing the D Key:

1. Point at the markpoint variable in the Data window, the memory range in the Memory window, or the codeline in the Source window:
2. Holding down the left mouse button, press the D key.
3. The markpoint is deleted and the blue letter L in front of the variable, memory range or codeline is removed.

Choosing Show Markpoints from Appropriate Context Menu:

1. Point in the Data, Memory or Source component window and right-click. That window's context menu is displayed.
2. Choose **Show Markpoints** from the Context Menu. The Markpoints Tab of the Controlpoints Configuration Window is displayed.
3. In this tab's List box, select the markpoint(s) you want to delete.
4. Click **Delete**. The selected markpoint is removed from the list of defined watchpoints.
5. Click **OK** to close the window. The markpoint is deleted and the blue letter L in front of the variable, memory range, or code line is removed.

Halting on a Control Point

Code execution is halted when the program reaches either a breakpoint or a watchpoint, if the conditions specified in the definition of the breakpoint or watchpoint have been reached. Code execution is NOT halted when the program reaches a markpoint.

Counting Control Point

If the interval property is greater than 1, a counting control point has been defined. When the debugger is running, each time the control point is reached, its current value is decremented. The debugger halts when the value reaches zero (0). When the debugger stops on the control point, a command executes (if defined and enabled).

Conditional Control Point

If a condition has been defined and enabled for a control point that halts the debugger, a command executes (if defined and enabled).

Control Point with Command

When the debugger halts on the control point, a specified command executes.

Real Time Kernel Awareness

The Debugger allows you to load and control applications on the target system, or applications simulated on the host. It also allows you to inspect the state of the application, which includes global variables, processor registers and the procedure call chain including the local (automatic) variables.

This chapter describes how applications built of several tasks are handled by a generic awareness support and an OSEK awareness.

Topics in this chapter include:

- [Introduction](#)
- [Task Description Language](#)
- [Application Example](#)
- [Inspecting Kernel Data Structures](#)
- [OSEK Kernel Awareness](#)

Introduction

Often operating systems (Real Time Kernels) are used to coordinate the different tasks in more complex systems. This chapter describes how applications built of several tasks can be handled with the Debugger. There are two main topics to be considered:

- Debugging of any task in the system (e.g., viewing the state of any task in the system). When using the original basic versions of the Debugger, only the current task can be inspected. Due to this extension, it is possible to switch the debugging context from the current task to any other task in the system.
- Real time kernels use data structures to describe the state of the system (scheduling information, queues, timers, etc.). Some of these data structures are described in this chapter.

Inspecting Task State

Each multitasking operating system stores the context of each task at a specific location, usually called the task descriptor. This context consists of the CPU context (CPU registers) and the content of the associated stack. There is more information in the task descriptor, depending on the specific implementation of the kernel.

The Debugger allows you to inspect the CPU registers and stack containing all procedure activation frames (return addresses, parameters, local variables). Therefore, it has to get this information for each task to be debugged. Since this information is specific to the kernel used, there is a universal way to specify the location where and how to collect this data.

This information is read from a file with the name `OSPARAM.PRM`, which describes the algorithm of how to get all the needed data from the target memory (from the task descriptors). To describe this algorithm, a simple procedural language is used. The only parameter to the algorithm is an address specified by the user, which identifies the task to be inspected. The result is the CPU context (CPU registers) and status of the task, which allows the debugger to display the procedure activation stack in a symbolic way.

RTK Interface

When the application is halted, the debugger displays the state of the current task. To identify the task to be inspected, the user has to follow these steps.

Make the task descriptor or a pointer to it visible in any of the debugger's data windows.

Press the **P** key while holding down the left mouse button on a variable of type "pointer to task descriptor".

Now the current state of the selected task and procedure chain of that task is displayed in the 'Procedure Chain' window. By clicking on the procedures in the call chain list, the local data of that function is displayed in the **Data1** window. All the usual debugging functions are also available to inspect this task (including displaying the register contents).

Task Description Language

To debug a task, a file named `OSPARAM.PRM` has to be created and must be stored in one of the directories specified in [GENPATH: #include "File" Path](#).

The file `OSPARAM.PRM` describes the algorithm to collect the context information for a specific task (the PC, SP, DL, SR and registers).

The following syntax must be used to specify the algorithm (in EBNF):

```
StatSequence = Statement] {';' Statement};
Statement = Assignment | ErrorMessage | If.
```

```

Assignment = Ident ':=' Expression.
ErrorMsg = 'MSG' ':=' String.
IfStatemen = 'IF' BoolExpr 'THEN' StatSequence {ELSIFPart} [ELSEPart]
'END'.
ELSIFPart = 'ELSIF' BoolExpr 'THEN' StatSequence.
ELSEPart = 'ELSE' StatSequence.
String = '"' {char} '"'.
BoolExpr = Expression RelOp Expression.
Expression = Term {Op Term}.
Term = Ident | Function | Number.
Ident = 'a'..'z' | 'R00'..'R31' | 'DL' | 'SP' | 'SR' | 'PC' | 'STATUS'
| 'B'.
Function = ('MB' | 'MW' | 'MD' | 'MA') '[' Expression ']'.
RelOp = '#' | '<' | '<=' | '=' | '>=' | '>'.
Op = '+' | '-'.

```

The terminal symbols have the following meaning:

- B – is the given reference to the task descriptor (initialized upon start).
- a-z – are variables for intermediate storage.
- MB – gets value of memory BYTE at given address.
- MW – gets value of memory WORD at given address.
- MD – gets value of DOUBLE WORD at given address.
- MA – gets value at given address interpreted as DOUBLE WORD.
- PC – is the program counter to be set.
- SP – is the stack pointer to be set.
- SR – is the status register value to be set.
- DL – is the dynamic link (data base) to be set (if not available, same as SP).
- STATUS – is the error number to be set (refer to manual).
- Rnn – processor registers to be set (mapping to CPU registers; see manual).
- MSG – is the error message (must be specified if N >= 1000).

On activation of the task debugging command, the file `OSPARAM.PRM` is opened and the selected address is stored in variable '**B**'. Then the commands in the file are interpreted. The CPU context of the task is then expected in the variables PC, SP, SR, DL, Rnn and EN. EN describes the status of the task. If 'EN' is bigger than 1000 the status is expected in the string MSG.

Application Example

[Listing 5.1](#) shows an example of a OSPARAM.PRM file for SOOM System/REM.

Listing 5.1 OSPARAM.PRM File

```
{ File OSParam.PRM, implementation for SOOM System/REM }
{ R0..R7 = D0..D7, R8..R15 = A0..A7 }
{ MSG = message displayed in Procedure Chain window }

DL := MD(B+8); { A6 in PD, dynamic link    }
SP := MD(B+4); { A7 in PD, stack pointer  }
PC := MD(B+14); { PC in PD, program counter }
SR := MW(B+12); { SR in PD, status register }
STATUS := 1000; { Initialized with 1000 }
IF MW(B+18) = 1 THEN
{ IF (registers are saved in task Control Block) THEN }
R0 := MD(B+22); R1 := MD(B+26); R2 := MD(B+30);
R3 := MD(B+34); R4 := MD(B+38); R5 := MD(B+42);
R6 := MD(B+46); R7 := MD(B+50); R8 := MD(B+54);
R9 := MD(B+58); R10 := MD(B+62); R11 := MD(B+66);
R12 := MD(B+70)
END;
R13 := B;
R14 := DL;
R15 := SP;
i := MB(B+112); { i contains the current state of the selected task. }
IF i = 0 THEN MSG := "ReadyInCQSc"
ELSIF i = 1 THEN MSG := "BlockedByAccept"
ELSIF i = 2 THEN MSG := "WaitForDReply"
ELSIF i = 3 THEN MSG := "WaitForMail"
ELSIF i = 4 THEN MSG := "DelayQueue"
ELSIF i = 5 THEN MSG := "BlockedByReceive"
ELSIF i = 6 THEN MSG := "WaitForSemaphore"
ELSIF i = 7 THEN MSG := "Dummy"
ELSIF i = 8 THEN MSG := "SysBlocked"
ELSE MSG := "invalid"
END;
```

Inspecting Kernel Data Structures

To allow the debugger to display the data structures of the operating system, the corresponding symbol information has to be available. This is the case when using SOOM System/REM. When another kernel is used its source code must be available and must be compiled. However, if only the object code is available, the needed symbol information can be generated in the following way:

- The kernel data structures of interest must be described using ANSI-C language, as shown in [Listing 5.2](#).

Listing 5.2 Kernel Data Structure Description

```
typedef struct PD {
    int status;
    struct PD *next;
    long regs[6];
} PD;
```

This is an example of the definition of a simple task descriptor.

- Variables can be collected in a structure and must be assigned to a segment (for example, OS_DATA shown in [Listing 5.3](#)).

Listing 5.3 OS_DATA Structure

```
#pragma DATA_SEG OS_DATA
struct {
    PD *readyList; /* list of tasks ready to be executed */
    char filler[6]; /* unimportant variables */
    int processes; /* total number of tasks */
    PD processes[10]; /* the 10 possible tasks */
} OS_DATA;
```

Define this structure so that it fits the same layout as the operating system. It might be necessary to introduce filler variables to get the correct alignment.

The linker must place this segment to the correct address by using the PRM file shown in [Listing 5.4](#):

Listing 5.4 Linker PRM File

```
NAMES ... rtk.o+ ... END
SECTIONS
...
    RTK_SEC = NO_INIT 0x1040 TO 0x1F80;
...
```

Real Time Kernel Awareness

OSEK Kernel Awareness

```

END

PLACEMENT
    . . .
    OS_DATA INTO RTK_SEC;
    . . .
END

```

The source file (for example: `rtk.c`) has to be compiled and listed in the NAMES section of the linker parameter file. To force linking, the name of the object file has to be immediately followed by a '+'. In this example the variable is linked to the address 0x1040.

If an application is prepared in this way, all declared variables may be inspected in the data windows of the Debugger. There is no restriction in the complexity of the structures to describe the global data of the kernel.

NOTE Do not open the terminal window during testing. Errors detected during reading of a PRM file are written to this window.

OSEK Kernel Awareness

OSEK Kernel provides a framework for building real-time applications.

OSEK Kernel awareness within the debugger allows you to debug your application from the operating system perspective.

The CodeWarrior Debugger supports OSEK ORTI compliant real-time operating systems and offers dedicated kernel awareness, using the information stored in your application's ORTI file.

With CodeWarrior OSEK kernel awareness, you can monitor kernel task information, semaphores, messages, queues, resources allocations, synchronization, communicating between tasks, etc.

ORTI describes the applications in any OSEK implementation:

- A set of attributes for system objects.
- A method for interpreting the data obtained.

OSEK Run Time Interface

The OSEK Run Time Interface (ORTI) is an interface for development tools to the OSEK Operating System. It is a part of the OSEK standard (refer to www.osek-vdx.org).

The ORTI enables the attached tool to evaluate and display information about the operating system, its state, its performance, the different task states, the different operating system objects etc.

ORTI File and Filename

The ORTI file name has the same name as the application file name, but with the extension `.ort`. For instance, if the application file name is `winLift_demo.abs`, the ORTI file name is `winLift_demo.ort`. Otherwise the debugger cannot use the correct ORTI file.

The ORTI file contains dynamic information as a set of attributes that are represented by formulas to access corresponding dynamic values. Formulas for dynamic data access are comprised of constants, operations, and symbolic names within the target file. The given formula can then be evaluated by the debug tool to obtain internal values of the required OS objects.

Figure 5.1 ORTI Aware Debugging System

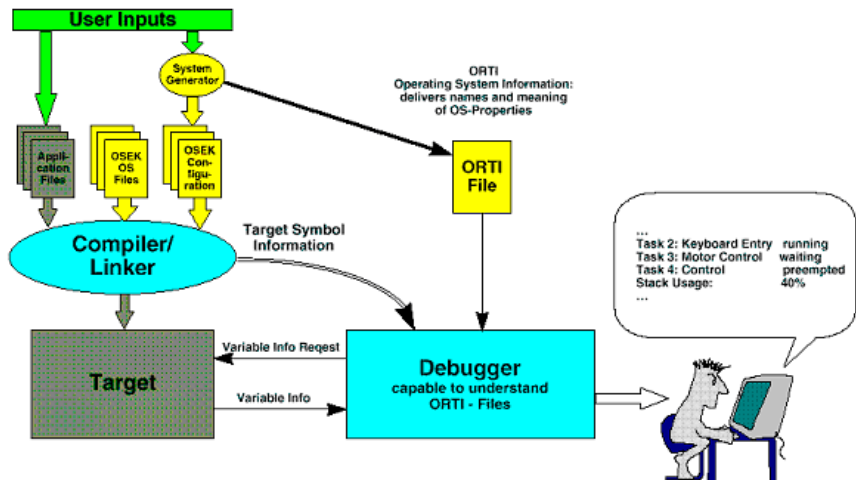

Two types of data are made available to the CodeWarrior IDE debug tool. One type describes static configuration data that remains unchanged during program execution. The second type of data is dynamic and this data is re-evaluated each time by the CodeWarrior IDE. The static information is useful for display of general information and in

Real Time Kernel Awareness

OSEK Kernel Awareness

combination with the dynamic data. The dynamic data gives information about the current status of the system.

The information given to the CodeWarrior IDE is represented in a text file (ORTI-File). The file describes the different objects configured in the OS and their properties. The information is represented in direct text, enumerated values, Symbolic names, or an equation that may be used for evaluating the attribute.

The ORTI File is generated when building the project through the OSEK System Generator. The generated file has the same name and the same location as the executable file but its extension is `.ort`.

ORTI File Structure

The ORTI file structure builds on top of the structure of the OSEK OIL file. It consists of the following parts:

- Version Section - This section describes the version of the ORTI standard used for the current ORTI file.
- Implementation Definition Section - This section describes the method to use to interpret the data obtained for the value. This section may also detail the suggested display name for a given attribute.
- Application Definition Section - This section contains information on all objects that are currently available for a given system. This section also describes the method that shall be used to reference or calculate each required attribute. This information shall either be supplied as a static value or else a formula that shall be used to calculate the required value.

OSEK RTK Inspector Component

OSEK awareness is described through the CodeWarrior RTK Inspector component as shown in [Figure 5.2](#).

Inspector window is displayed by clicking on the *Component > Open* menu entry and then by clicking on **Inspect** icon in the Open Window Component window.

When the RTK components icon is selected in the hierarchical content of the items, the right side displays various information about OSEK Awareness.

Figure 5.2 CodeWarrior RTK Inspect Window

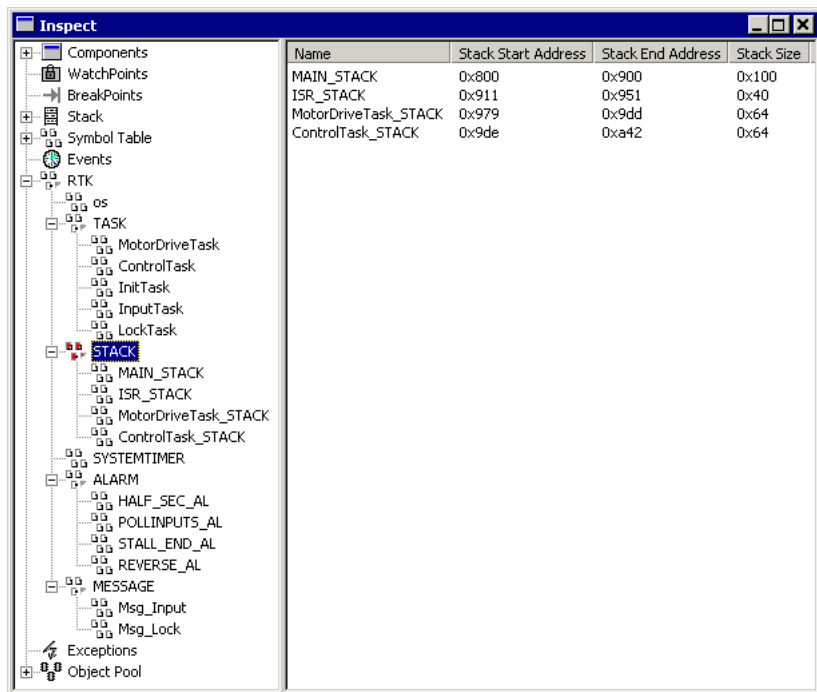

The OSEK RTK Inspect Window provides access to all this information. As defined in the ORTI file, objects of the same type are grouped and can be viewed together.

- Task
- Stack
- SystemTimer
- Alarm
- Message

The following sections offer a description of typical objects along with their attributes and how they are presented.

NOTE Objects and their attributes depend on the OSEK implementation and OSEK configuration, and therefore may differ from this description.

Inspector Task

The Task shown in [Figure 5.3](#) displays the current state of the OSEK task trace.

Figure 5.3 Inspector Task

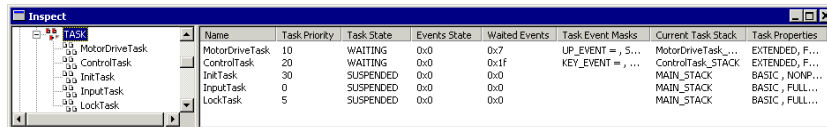

Name	Task Priority	Task State	Events State	Waited Events	Task Event Masks	Current Task Stack	Task Properties
MotorDriveTask	10	WAITING	0x0	0x7	UP_EVENT =, 5...	MotorDriveTask...	EXTENDED, F...
ControlTask	20	WAITING	0x0	0x1f	KEY_EVENT =, ...	ControlTask_STACK	EXTENDED, F...
InitTask	30	SUSPENDED	0x0	0x0		MAIN_STACK	BASIC, NONP...
InputTask	0	SUSPENDED	0x0	0x0		MAIN_STACK	BASIC, FULL...
LockTask	5	SUSPENDED	0x0	0x0		MAIN_STACK	BASIC, FULL...

When selecting Task in the hierarchical tree on the left side of the Inspect window, additional information concerning tasks is displayed on the right side of the window under the following headings:

- **Name:** displays the name of the task
- **Task Priority:** displays the priority of the task.
- **Task State:** describes the current state of the task. Possible values are READY, SUPENDED, WAITING, RUNNING or INVALID_TASK. The ORTI file defines the different states.
- **Events State:** the event is represented by its mask. The event mask is the number whose range is from 1 to 0xFFFFFFFF. When the event mask value is set to 1, the event is activated. When it is set to 0, the event is disabled.
- **Waited Events:** when the bit is set to 0, the event is not expected. When the bit is set to 1, the event is expected.
- **Task Event Masks:** describes the current task event mask.
- **Current Task Stack:** displays the name of the current stack used by the task.
- **Task Properties:** describes task properties. Possible value are BASIC/EXTENDED, NONPREMPT/FULLPREMPT, Priority value, AUTO. The ORTI file defines the possible values.

Inspector Stack

The Stack shown in [Figure 5.4](#) displays the current state of OSEK stack trace.

Figure 5.4 Inspector Stack

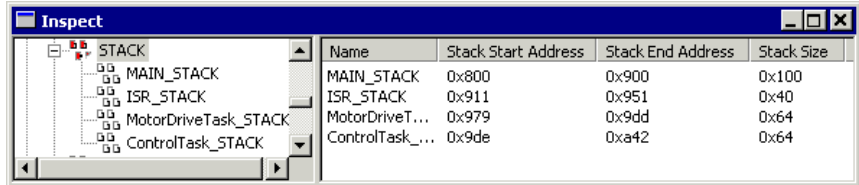

Select Stack in the hierarchical tree on the left side to display additional information concerning the stack on the right side of the window under the following headings:

- **Name:** displays the name of the stack.
- **Stack Start Address:** displays the start address of the stack.
- **Stack End Address:** displays the end address of the stack.
- **Stack Size:** displays the size of the stack.

Inspector SystemTimer

The SystemTimer shown in [Figure 5.5](#) displays the current state of OSEK SystemTimer trace.

Figure 5.5 Inspector SystemTimer

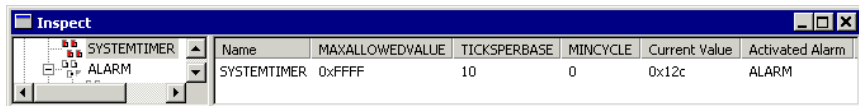

Select SystemTimer in the hierarchical tree on the left side to display additional information concerning the timer on the right side of the window under the following headings:

- **Name:** displays name of the system timer.
- **MAXALLOWEDVALUE:** displays the maximum allowed counter value. When the counter reaches this value it rolls over and starts again from zero.
- **TICKSPERBASE:** displays the number of ticks required to reach a counter-specific value.
- **MINCYCLE:** displays the minimum allowed number of counter ticks for a cyclic alarm linked to the counter.

Real Time Kernel Awareness

OSEK Kernel Awareness

- **Current Value:** displays the current value of the system timer.
- **Activated Alarm:** displays associated alarms.

Inspector Alarm

The Alarm shown in [Figure 5.6](#) displays the current state of OSEK alarm trace.

Figure 5.6 Inspector Alarm

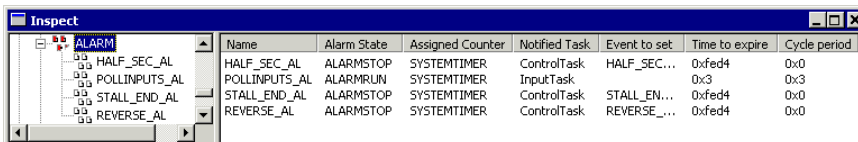

Name	Alarm State	Assigned Counter	Notified Task	Event to set	Time to expire	Cycle period
HALF_SEC_AL	ALARMSTOP	SYSTEMTIMER	ControlTask	HALF_SEC...	0xfed4	0x0
POLLINPUTS_AL	ALARMRUN	SYSTEMTIMER	InputTask		0x3	0x3
STALL_END_AL	ALARMSTOP	SYSTEMTIMER	ControlTask	STALL_EN...	0xfed4	0x0
REVERSE_AL	ALARMSTOP	SYSTEMTIMER	ControlTask	REVERSE_...	0xfed4	0x0

Select Alarm in the hierarchical tree on the left side to display additional information concerning the alarm on the right side of the window under the following headings:

- **Name:** displays the name of the alarm.
- **Alarm State:** displays the current state of the alarm. Possible values are ALARMRUN and ALARMSTOP.
- **Assigned Counter:** based on counters, the OSEK OS offers an alarm mechanism for the application software. Assigned Counter is the name of the counter used by the alarm.
- **Notified Task:** alarm management allows the user to link task activation to a certain counter value, assign an alarm to a counter, and define the action to be performed when an alarm expires. Notified Task defines the task to be notified (by activation or event setting) when the alarm expires.
- **Event to Set:** alarm management allows the user to link event setting to a certain counter value, assign an alarm to a counter, and define the action to be performed when an alarm expires. Event to set specifies the event mask to be set when the alarm expires.
- **Time to expire:** displays time remaining before the time expires and the event is set.
- **Cycle period:** displays period of a tick.

Inspector Message

The Message shown in [Figure 5.7](#) displays the current state of OSEK message trace.

Figure 5.7 Inspector Message

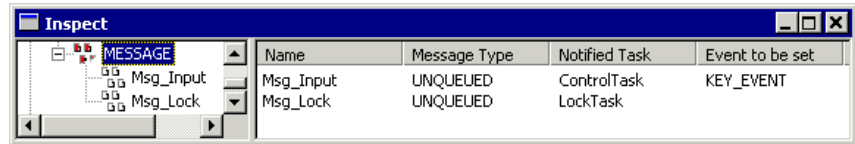

Select Message in the hierarchical tree on the left side to display additional information concerning task on the right side:

- **Name:** displays the name of the message.
- **Message Type:** displays message type. Possible values are: UNQUEUED/QUEUED.
- **Notified Task:** displays the task that shall be activated when the message is sent.
- **Event to be set:** displays the event to be set when the message is sent.



Real Time Kernel Awareness
OSEK Kernel Awareness

How To...

This chapter provides answers to frequently asked questions. Topics include:

- [How To Configure the Debugger](#)
- [Starting Debugger from CodeWarrior IDE](#)
- [Automating Debugger Startup](#)
- [How To Load an Application](#)
- [How to Start an Application](#)
- [How to Stop an Application](#)
- [How to Step in the Application](#)
- [How to Work on Variables](#)
- [How to Work on the Register](#)
- [Modify Content of Memory Address](#)
- [How to Consult Assembler Instructions Generated by a Source Statement](#)
- [How to View Code](#)
- [How to Communicate with the Application](#)

How To Configure the Debugger

If you have installed the Debugger under Windows 2000 or higher, the Debugger can be started from the CodeWarrior IDE, from the desktop, from the Start menu, or from an external editor. In order to work efficiently, the Debugger must be associated with a working directory.

For Use from Desktop

When starting the Debugger, the working directory can be defined in the file `MCUTOOLS.INI`, located in the Windows directory.

How To...

Starting Debugger from CodeWarrior IDE

Defining the Default Directory in the MCUTOOLS.INI

When starting from the desktop or Start menu, the working directory can be set in the configuration file MCUTOOLS.INI.

The working directory including the path is defined in the environment variable **DefaultDir** in the [Options] group or **WorkDir** [WorkingDirectory].

Starting Debugger from CodeWarrior IDE

The Debugger can be started by selecting *Project > Debug* or clicking the Debugger icon (bug) in project window. The Window looks similar to [Figure 6.1](#), but varies depending on your project.

Figure 6.1 Debugger After Startup

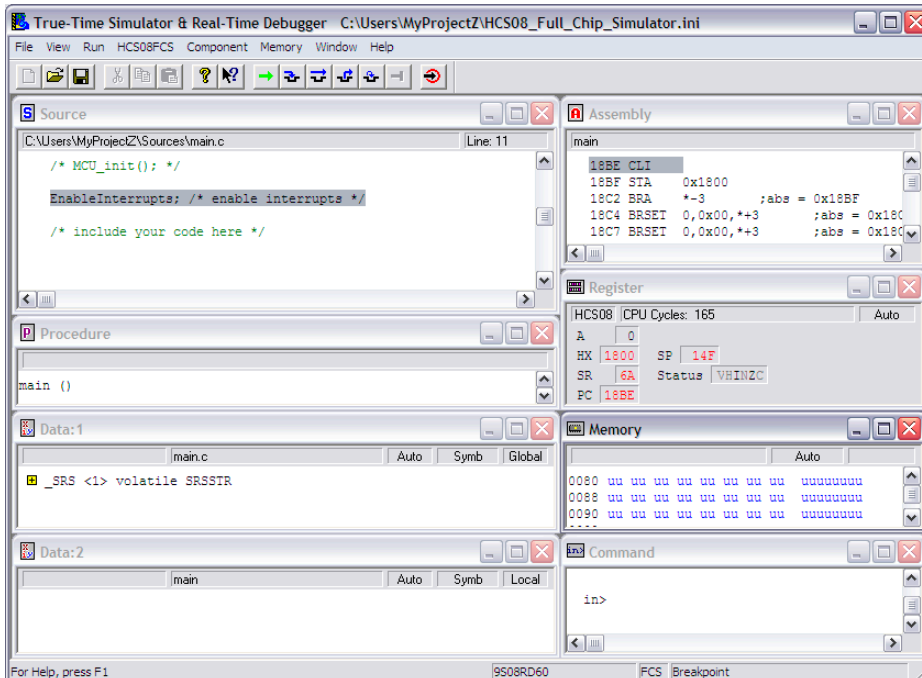

READY displayed in the status bar indicates that the simulator is ready.

Automating Debugger Startup

Often the same tasks have to be performed after starting the Debugger. These tasks can be automated by writing a command file that contains all commands to be executed after startup of the Debugger, as shown in [Listing 6.1](#).

Listing 6.1 Example of a Command File to Automate Tasks

```
load fibo.abs
bs &main t
g
```

This file first loads an application, then sets a temporary breakpoint at the start of the function **main** and start the application. The application then stops on entering **main** (after executing the startup and initialization code).

There are several ways to execute this command file:

- Specify the command file on the command line using the command line option `-c`. Do this in the application that starts the Debugger (for example, Editor, Explorer, or Make utility).

Example:

```
\Freescale\CodeWarrior for Microcontrollers
V6.1\PROG\HIWAVE.EXE -c init.cmd
```

When you start the Debugger with this command line, it executes the command specified in the file `init.cmd`, after loading the layout (or project file).

- Calling the command file from the project file ([Listing 6.2](#)). The project file in which you save the layout and connection component (*File > Save*) is a normal text file that contains command line commands to restore the context of a project. Once you create this file using the save command, you can extend it by a call to the command file (**CALL INIT.CMD**). Loading this project using the *File > Open* command or the corresponding entry in the Project file executes the commands in this file.

Listing 6.2 Calling a Command File from the Project File:

```
set Sim
CLOSE *
call \Freescale\DEMO\test.hwl
call init.cmd
```

- Calling the command file when the Connection Component is loaded. Most connection components execute the command file `STARTUP.CMD` once the connection component is loaded and initialized. By adding the call command file in

How To...

How To Load an Application

this file (for example, `CALL_INIT.CMD`), it automatically executes when the connection component is loaded.

NOTE Refer to [Starting Debugger from CodeWarrior IDE](#).

How To Load an Application

1. Choose *HCS08FCS > Load*. The **Load Executable File** dialog box opens.
2. Select an application (for example `FIBO.ABS`).
3. Click **OK**. The dialog box is closed and the application is loaded in the Debugger (refer to [Figure 6.1](#)).

The Source component contains source from the module containing the entry point for the application (usually the startup module). The highlighted statement is the entry point.

The Assembly component contains the corresponding disassembled code. The highlighted statement is the entry point.

The Data:1 component contains the list of global variables defined in the module containing the application entry point.

The Data:2 component lists local variables, if any are available.

The PC in the Register component is initialized with the PC value from the application entry point.

How to Start an Application

There are two different ways to start an application:

- Choose *Run > Start/Continue*
- Click the *Start > Continue* icon in the debugger tool bar 

RUNNING in the status line indicates that the application is running.

The application continues execution until:

- you decide to stop the execution (See [How to Stop an Application](#)).
- it reaches a breakpoint or watchpoint.
- it detects an exception (watchpoints or breakpoints).

How to Stop an Application

There are two ways to stop program execution:

- Choose *Run >Halt*
- Click on the **Halt** icon in the debugger tool bar 

HALTED in the status line indicates that execution has been stopped.

The blue highlighted line in the source component is the source statement at which the program was stopped (next statement to be executed).

The blue highlighted line in the Assembly component is the assembler statement at which the program was stopped (next assembler instruction to be executed).

Data window with attribute **Global** displays the name and values of the global variables defined in the module where the currently executed procedure is implemented. The name of the module is specified in the Data info bar.

Data window with attribute **Local** displays the name and values of the local variables defined in the current procedure. The name of the procedure is specified in the Data info bar.

How to Step in the Application

The Debugger provides stepping functions at the application source level and assembler level ([Figure 6.2](#)).

On Source Level

Figure 6.2 Stepping at Source Level

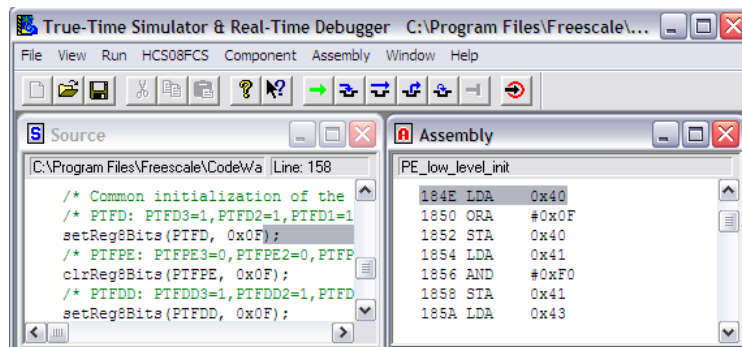

How To...

How to Step in the Application

On the Next Source Instruction

The Debugger provides two ways of stepping to the next source instruction:

- Choose *Run > Single Step*
- Click the **Single Step** icon from the Debugger tool bar 

STEPPED in the status line indicates that the application is stopped by a step function.

If the application was previously stopped on a subroutine call instruction, a **Single Step** stops the application at the beginning of the invoked function.

The display in the Assembly component is always synchronized with the display in the Source component. The highlighted instruction in the Assembly component is the first assembler instruction generated by the highlighted instruction in the Source component.

Elements from Register, Memory or Data components that are displayed in red are the register, memory position, local or global variables, and which values have changed during execution of the source statement.

Step Over a Function Call (Flat Step)

The Debugger provides two ways of stepping over a function call:

- Choose *Run > Step Over*
- Click the **Step Over** icon from the Debugger tool bar 

STEPPED OVER ([STEPOVER](#)) or STOPPED ([STOP](#)) in the status line indicates that the application is stopped by a step over function.

If the application was previously stopped on a function invocation, a **Step Over** stops the application on the source instruction following the function invocation.

The display in the Assembly component is always synchronized with the display in the Source component. The highlighted instruction in the Assembly component is the first assembler instruction generated by the highlighted instruction in the Source component.

Elements from Register, Memory or Data components that are displayed in red are the register, memory position, local or global variables, and which values have changed during execution of the invoked function.

Step Out from a Function Call

The Debugger provides two ways of stepping out from a function call:

- Choose *Run > Step Out*
- Click the **Step Out** icon from the debugger tool bar 

STOPPED ([STOP](#)) in the status line indicates that the application is stopped by a step out function.

If the application was previously stopped in a function, a **Step Out** stops the application on the source instruction following the function invocation.

The display in the Assembly component is always synchronized with the display in the Source component. The highlighted instruction in the Assembly component is the first assembler instruction generated by the highlighted instruction in the Source component.

Elements from Register, Memory or Data components that are displayed in red are the register, memory position, local or global variables, and which values have changed since the **Step Out** was executed.

Step on Assembly Level

The Debugger provides two ways of stepping to the next assembler instruction:

- Choose *Run > Assembly Step*
- Click the **Assembly Step** icon from the debugger tool bar 

TRACED in the status line indicates that the application is stopped by an assembly step function.

The application stops at the next assembler instruction.

The display in the Source component is always synchronized with the display in the Assembly component. The highlighted instruction in the Source Component is the source instruction that has generated the highlighted instruction in the Assembly component.

Elements from Register, Memory or Data components that are displayed in red are the register, memory position, local or global variables, and which values have changed during execution of the assembler instruction.

How to Work on Variables

This section describes the different methods to work on variables.

Display Local Variable from a Function

The Debugger provides two ways to see the list of local variables defined in a function:

- Drag and Drop
Drag a function name from the Procedure component to a Data component with attribute **local**.

How To...

How to Work on Variables

- Double-click

Double-click a function name in the Procedure component.

The Data component (for **local** that is neither **frozen** or **locked**) displays the list of variables defined in the selected function with their values and type.

Display Global Variable from a Module

The Debugger provides two ways to see a list of global variables defined in a module:

Opening Module Component

1. Choose *Component > Open*. The list of all available components is displayed on the screen.
 2. Double-click the entry **Module**. A module component is opened, which contains the list of all modules building the application.
 3. Drag a module name from the **Module** component to a Data component with attribute **Global**.
-

Using Context Menu

1. Right-click in a Data component with attribute **Global**.
2. Choose **Open Module** in Context Menu. A dialog box is opened, which contains the list of all modules building the application.
3. Double-click on a module name. The Data component for **global**, which is neither **frozen** nor **locked** is the destination component.

The destination Data component displays the list of variables defined in the selected module with their values.

Change Format for Variable Value Display

The Debugger allows you to see the value of variables in different formats. This is set by entries in the **Format** menu ([Table 6.1](#)).

Table 6.1 Debugger Display Format

Menu entry	Description
Hex	Variable values are displayed in hexadecimal format.
Oct	Variable values are displayed in octal format.
Dec	Variable values are displayed in signed decimal format.
UDec	Variable values are displayed in unsigned decimal format.
Bin	Variable values are displayed in binary format.
Symbolic	Displayed format depends on variable type.

- Values for pointer variables are displayed in hexadecimal format.
- Values for function pointer variables are displayed as function name.
- Values for character variables are displayed in ASCII character and decimal format.
- Values for other variables are displayed in signed or unsigned decimal format depending on the variable being signed or not.

Format menu is activated as follows:

1. Right-click in the Data component. The Data Context Menu is displayed on the screen.
2. Choose **Format** from Context Menu. The list of formats is displayed on the screen.

The format selected is valid for the whole Data component. Values from all variables in the data component are displayed according to the selected format.

Modify a Variable Value

The Debugger allows you to change the value of a variable, as shown in [Figure 6.3](#).

Figure 6.3 Modifying a Variable Value

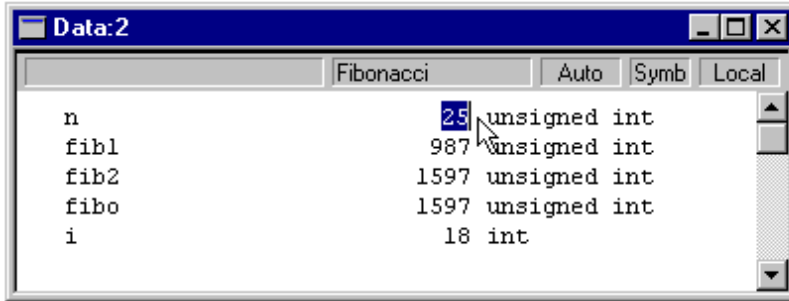

Double-click on a variable. The current variable value is highlighted and can be edited.

1. Formats for the input value follow the rule from ANSI C constant values (prefixed by 0x for hexadecimal value, prefixed by 0 for octal values, otherwise considered as decimal value). For example, if the data component is in decimal format and if a variable input value is 0x20, the variable is initialized with 32. If a variable input value is 020, the variable is initialized with 16.
2. To validate the input value you can either press the **Enter** or **Tab** key.
3. If an input value has been validated by the **Tab** key, the value of the next variable in the component is automatically highlighted (this value can also be edited).
4. To restore the previous variable value, press the **Esc** key or select another variable.

A local variable can be modified when the application is stopped. Since these variables are located on the stack, they do not exist as long as the function where they are defined is not active.

Get the Address Where a Variable is Allocated

The Debugger provides you with the start address and size of a variable if you do the following:

1. Point to a variable name in a Data Component
2. Click the variable name

The start address and size of the selected variable is displayed in the Data info bar.

Inspect Memory Starting at a Variable Location Address

The Debugger provides two ways to dump the memory starting at a variable allocation address.

- Using Drag and Drop

Drag a variable name from the Data Component to Memory component.

- Holding down the left mouse button and pressing the A key

Point to a variable name in a Data Component, hold the left mouse button down and press the A key.

The memory component scrolls until it reaches the address where the selected variable is allocated. The memory range corresponding to the selected variable is highlighted in the memory component.

Load an Address Register with the Address of a Variable

The Debugger allows you to load a register with the address where a variable is allocated. Drag a variable name from the Data Component to Register component. The destination register is updated with the start address of the selected variable.

How to Work on the Register

This section describes how to work with the Register component.

Change Format of Register Display

The Debugger allows you to display the register content in hexadecimal or binary format.

1. Right-click in the Register component. The Register context menu is displayed on the screen.
2. Choose *Options* from the context menu. The list menu containing the possible formats is displayed.
3. Select either binary or hexadecimal format.

The format selected is valid for the Register component. The contents from all registers are displayed according to the selected format.

How To...

How to Work on the Register

Modify a Register Content

The Debugger allows you to change the content of indexes, accumulators or bit registers.

Modify Index or Accumulator Register Content

Double-click a register. The current register content is highlighted and may be edited.

Figure 6.4 Modifying Index or Accumulator Register Content

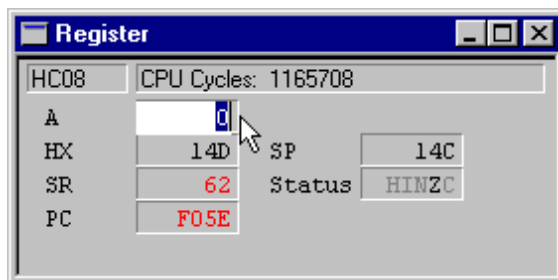

1. The format of the input value depends on the format selected for the data component. If the format of the component is **Hex**, the input value is treated as a Hex value. If the input value is 10 the variable is set to $0 \times 10 = 16$.
2. To validate the input value, either press the **Enter** or **Tab** key, or select another register.
3. Validating an input value using the **Tab** key automatically highlights the content of the next register in the component. You can edit this register also.
4. To restore the previous register content, press the **Esc** key.

Modify Bit Register Content

In a bit register, each bit has a specific meaning: a Status Register (SR) or Condition Code Register (CCR).

Mnemonic characters for bits that are set to 1 appear in black, whereas mnemonic characters for bits that are cleared to 0 appear in gray.

You can toggle single bits inside the bit register by double-clicking the corresponding mnemonic character.

Start Memory Dump at Address Where Register is Pointing

The Debugger provides two ways to dump memory starting at the address to which a register points.

Using Drag and Drop

- Drag a register from the Register component to Memory component.

Choose Address

Figure 6.5 Memory menu Display Address

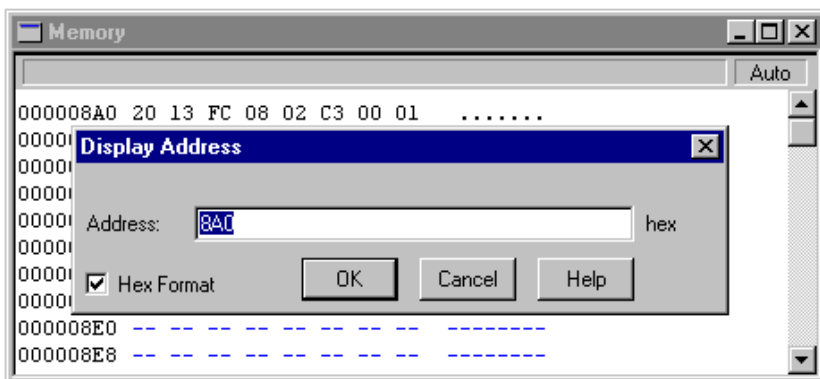

1. Right-click in the Memory component to display the *Memory* context menu.
2. Choose *Address* from the context menu to open the **Memory** dialog box shown in [Figure 6.5](#).
3. Enter the register content in the Edit Box and choose **OK** to close the dialog box.

The memory component scrolls until it reaches the address stored in the register. This feature allows you to display a memory dump from the application stack.

NOTE If Hex Format is checked, numbers and letters are considered to be hexadecimal numbers. Otherwise, type expressions and prefix Hex numbers with **0x** or **\$**.

How To...

Modify Content of Memory Address

Modify Content of Memory Address

The Debugger allows you to change the content of a memory address. Double-click the memory address you want to modify. Content from the current memory location is highlighted and can be edited.

1. The format for the input value depends on the format selected for the Memory component. If the format for the component is **Hex**, the input value is treated as a Hex value. An input value of 10 sets the memory address to $0x10 = 16$.
2. Once a value has been allocated to a memory word, it is validated and the next memory address is automatically selected and can be edited.
3. To stop editing and validate the last input value, you can either press the **Enter** or **Tab** key, or select another variable.
4. To stop editing and restore the previous memory value, press the **Esc** key.

How to Consult Assembler Instructions Generated by a Source Statement

The Debugger provides an on-line disassembly facility, which allows you to disassemble the hexadecimal code directly from the Debugger code area. Online disassembly can be performed in one of the following ways:

Using Drag and Drop

1. In the Source component, select the section you want to disassemble.
2. Drag the highlighted block to the Assembly component.

Holding down the left mouse button and pressing the R key

1. In the Source component window, point to the instruction you want to disassemble.
2. Hold down the left mouse button and press the R key.

The disassembled code associated with the selected source instruction is grayed in the Assembly component.

How to View Code

The Debugger allows you to view the code associated with each assembler instruction.

Figure 6.6 Viewing Code Associated with Assembler instruction

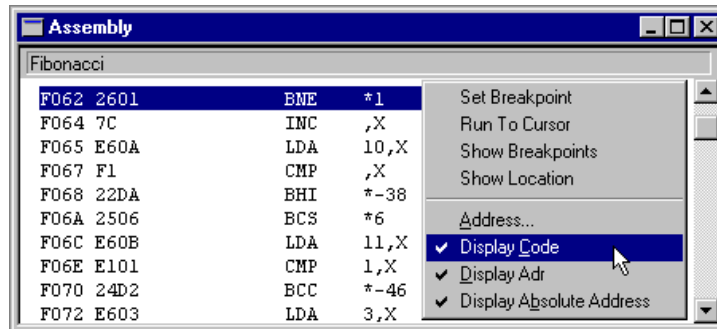

Online disassembly can be performed in one of the following ways:

Using Context Menu

1. Point in the Assembly component and right-click. The Assembly context menu is displayed.
2. Choose **Display Code** ([Figure 6.6](#)).

Using Assembly Menu

1. Click the title bar of the Assembly component. The Assembly menu appears in the debugger menu bar.
2. Choose *Assembly > Display Code*

The Assembly component displays the corresponding code on the left of each assembler instruction.

How To...

How to Communicate with the Application

How to Communicate with the Application

The Debugger has a pseudo-terminal facility. Use the **TestTerm** or **Terminal** component window to communicate with the application using specific functions defined in the `TERMINAL.H` file and used in the calculator demo file.

1. Start the Debugger and choose *Open* from the Component menu.
2. Open the **TestTerm** or **Terminal** Component.
3. Choose *Load* from the Simulator menu.
4. Load the program `CALC.ABS`.

The target application uses the **Read** function to fetch data entered in the **TestTerm** or **Terminal** component window through the keyboard. The target application uses the **Write** function to send data to the Terminal component window of the host.

CodeWarrior IDE Integration

This chapter provides information on how to use and configure the Simulator/Debugger within the CodeWarrior IDE using the following software:

- CodeWarrior IDE - CW08 version 3.1 or later

Debugger Configuration

The New Project Wizard in the CodeWarrior IDE has default debugger settings that are correct for most projects, and no changes are necessary for normal use. At times, however, you may wish to make some configuration changes.

CAUTION Changing the configuration from within the debugger may affect your project adversely. Under normal circumstances make all configuration changes in the CodeWarrior IDE.

To change the configuration the Real Time Debugger and True Time Simulator, follow these steps:

1. Start the IDE.
2. From the CodeWarrior IDE, open the **Target Settings Panel** by clicking on the Targets panel of the IDE main window.
3. Double click on the name of your target in the list displayed in this panel.
4. Select **Build Extras** as shown in [\(Figure 7.1\)](#).
5. In the **Build Extras** pane check the **Use External Debugger** checkbox.
6. In the Application field, type the Debugger path, (or select from the Open window by clicking the Browse button) for example: {Compiler}prog\hiwave.exe.
7. In the Arguments field, type the arguments, for example, %targetFilePath - Target=sim.
8. Click on **Apply** to validate these changes.

CodeWarrior IDE Integration

Debugger Configuration

Figure 7.1 IDE Target Window - Build Extras Panel

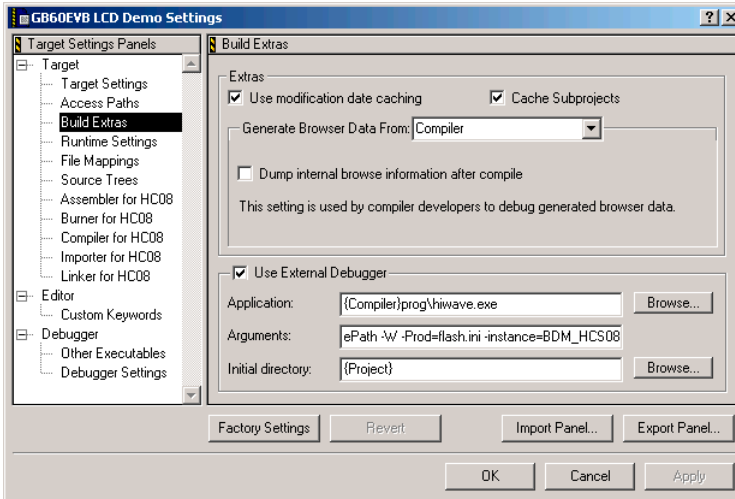

Debugger DDE Capabilities

Introduction

The DDE is a form of interprocess communication that uses shared memory to exchange data between applications. Applications can use DDE for one-time data transfers and for ongoing exchanges in applications that send updates to one another as new data becomes available.

NOTE The DDE capabilities of the Debugger are deprecated. Future versions of the Debugger will have no DDE capabilities. You can use the Component Object Model (COM) Interface.

DDE Implementation

The Debugger integrates a DDE server and DDE client implementation in the KERNEL. The DDE application name of the IDF server is "HI-WAVE".

The Debugger DDE support allows you to execute almost any command from the Command line, that is available within the debugger. There are also special DDE items for more commonly performed tasks.

This section describes topics and DDE items available to CodeWright clients. In addition to the required System topic, CurrentBuffer and the names of all CodeWright non-system buffers (documents) are available as topics.

Driving Debugger through DDE

The DDE implementation in the Debugger allows you to drive it easily by using the DDE command. To do this, you have to use a program that can send a DDE message (a DDE client application) like DDECLient.exe from Microsoft.

The service name of the Debugger DDE Server is **HI-WAVE** and the Topic name for the Debugger DDE Server is **Command**.

The following example is done with DDECLient.exe from Microsoft.

1. Run the Debugger and in the **Service** field in the DDECLient type: **HI-WAVE**
2. In the **Topic** field type **Command**

Debugger DDE Capabilities

3. Push the **Connect** button of the DDECLient. The following message appears in DDECLient: **Connected to HI-WAVE|Command**.
4. In the **Exec** field of DDECLient type a Debugger command, for example `open recorder` and click the **Exec** button. The command is executed by way of DDE and a new recorder component appears in the Debugger.

NOTE You can disconnect the DDE in the Debugger. The Debugger can be started without DDE (this is saved in the project file). To view the current state, open a command line component and type the following command: `DDEPROTOCOL STATUS`. The state must be: `DDEPROTOCOL ON` to ensure the DDE works properly.

Synchronized Debugging Through DA-C IDE

This chapter provides information on how to use and configure Freescale tools within the Development Assistant for C (DA-C) IDE. For more information on DA-C, refer to the *Development Assistant for C* documentation v 3.5.

You must be running:

DA-C - version 3.5 build 555 or later - (Development Assistant for C - RistanCASE).

Topics in this chapter include:

- [Configuring DA-C IDE for Freescale Tool Kit](#)
- [Debugger Interface](#)
- [Synchronized Debugging](#)
- [Troubleshooting](#)

Configuring DA-C IDE for Freescale Tool Kit

Install the DA-C software. The Freescale CD contains a demo version located in `\Addons\DA-C`. Run **Setup** to install the **Typical** installation.

A few configurations are required in order to make efficient use of Freescale Tools within DA-C IDE.

- Create a new project
- Configure the working directories
- Configure the file types
- Configure the Freescale library path
- Adding files to project
- Building the Database
- Configure the tools

In the following sections, we assume that the Freescale tool kit is installed in the `C:\Program Files\Freescale` directory. You may have to adapt the paths to your

Synchronized Debugging Through DA-C IDE

Configuring DA-C IDE for Freescale Tool Kit

current installation. An example configuration for the M68k CPU is provided, which can be adapted to each CPU supported by Freescale.

Create New Project

Start `DA-C.exe` and choose *Project > New Project* from the main menu. Browse to the directory and enter a project file name, for example:

```
C:\Program Files\Freescale\work\<<processor>c\myproject
```

Change the `<processor>` field to your CPU). A specific project file is created with `.dcp` extension (for example `myproject.dcp`).

Configure Working Directories

Choose *Options > Project* from the main menu of DA-C. The window shown in [Figure 9.1](#) contains options which establish directories for the project.

Figure 9.1 DA-C Project Options Window - Directories Tab

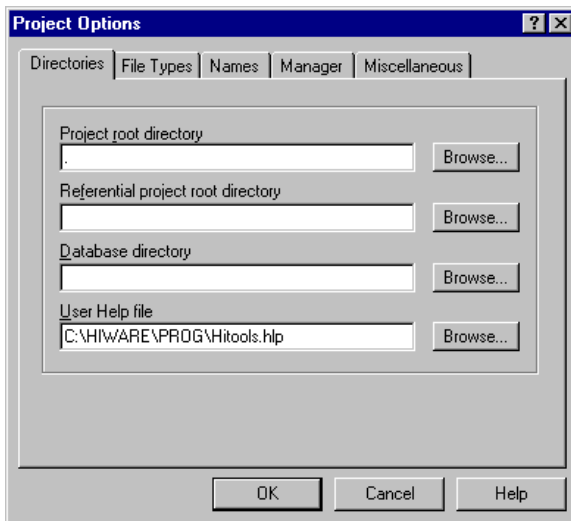

Project Root Directory

This text box determines the project root directory. The full path is expected, or a single dot can be entered, which stands for the same directory where the project file resides. All files that belong to the project are considered relative to the Project root directory, if the full path of the file is not given. In our case, keep the single dot for the project root directory.

Referential Project Root Directory

If not empty, this text box specifies an alternate Project Root Path for searching files not found in the original project path. Filenames in the original path with referential extensions are tried before those in the referential path. Specified path may be either full or relative to project root, and it may not specify a subdirectory in the project root directory tree. Leave this field empty.

Database Directory

This text box determines the directory in which to save the symbols and software metrics database. This directory can be absolute or relative to the Project Root Directory. Leave this field empty.

User Help File

This text box determines the user help file, for example compiler help file. The hot key for User Help File can be defined in the Keyboard definition file (default Ctrl-Shift-F1). Browse in the \prog directory of your Freescale installation and select the help file matching your CPU.

Configure File Types

From the main menu of DA-C choose *File Types* to configure the basic file types. The File Types Tab of the Project Options Window contains options, which determine file types of the project. For an efficient use of Freescale tools, [Figure 9.2](#) shows file extension types that can be defined.

Figure 9.2 DA-C Project Options Window - File Types Tab

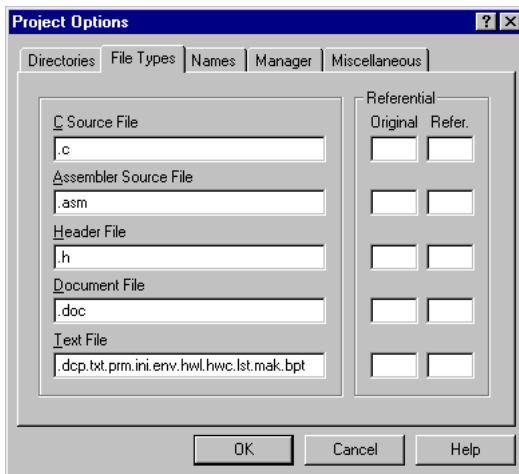

Configure Library Path

An additional configuration path must be defined to specify the location of library header files (needed for DA-C symbol analysis). This can be done by choosing *Options > Analysis for Symbols > C Source* in the main menu of DA-C.

The window shown in [Figure 9.3](#) contains options that determine parameters of the C source code analysis.

Figure 9.3 Analysis for Symbols Options Window - C Source Tab

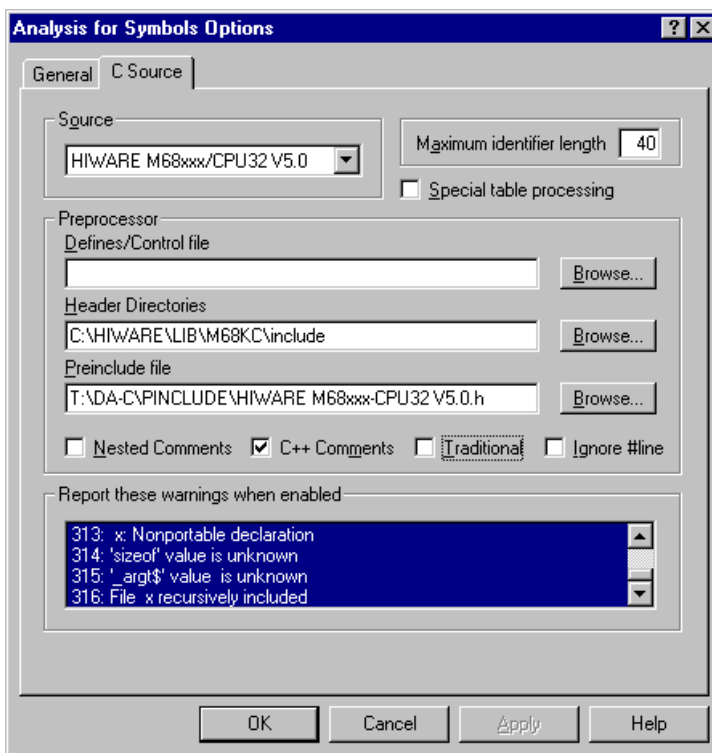

Source

The supported C dialects of the C language used in the current project can be selected in this text field. In our example we chose the Freescale M68k language (adapt it to your needs).

Preprocessor - Header Directories

This text box determines the list of directories that are to be searched for files named within the `#include` directive. A semicolon separates directories. Only listed directories are searched for files named between `<` and `>`. Searching for files named between quotation marks (`"`), starts in the directory of the source file containing `#include` directive.

The list of header directories can be assigned in a file. In that case, this field contains the file name (absolute or relative in relation to the project root) with prefix `@`. Directories are separated with a semi-colon or new line.

Define the library path matching your CPU (assuming Freescale tools are installed on `C:\Program Files\Freescale`):

```
C:\Program Files\Freescale\lib\<processor>c\include.
```

Preprocessor - Preinclude File

This text box determines the name of the file included automatically at the beginning of every source module during analysis, as if `#include "string"` were present in the first line. Use the preinclude file to specify predefined macros and variable and function declarations for a particular compiler, which are not set by default in DA-C analysis. We have selected the one corresponding to our example: M68k preinclude file (adapt it to your needs).

Adding Files to Project

In the Project Window the Explorer View Tab replaces the Window's Explorer and supplies you with additional information on directories containing project files. It also gives you the option to add files into the project. For example, we will now set all files needed to run the **fib0** example:

1. In the Explorer View, browse to the `\Freescale\WORK\ directory of your Freescale installation`
2. Select the `fib0.c` file.
3. Right-click mouse button and choose **Add to Project**.

The file is now added in the current project and a green mark appears in front of it ([Figure 9.4](#)).

Figure 9.4 Adding Files to Project Using Explorer Tab

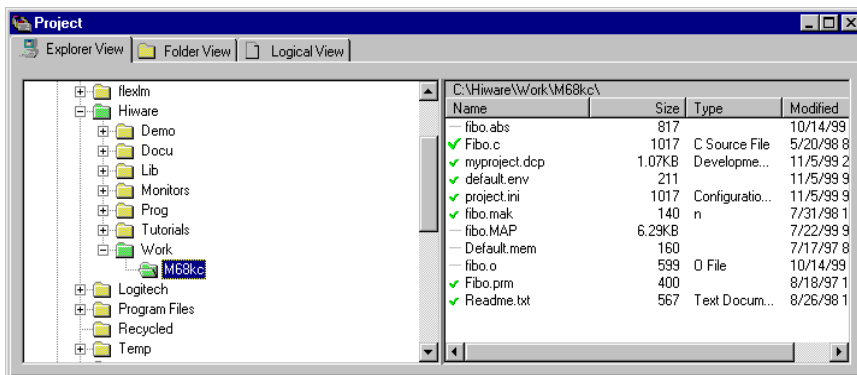

In the same way, select `fib0.prm` file and add it to this project.

You can also add a directory to the project in the following way:

- Select Explorer View Tab in Project Window.
- In the left section, select the directory with files to be added to the project (files from subdirectories may also be added to the project).
- From context menu choose **Add to project**.

This operation may also be performed from Folder view, if the directory is in the left section.

NOTE When adding an entire directory to the project, only files with extensions defined in *Options > Project > File types* (as described in the section [Configure File Types](#)) are added.

Building The Database

Development Assistant for C provides the static code analysis of C source files, as well as generating various data based on the results.

Analysis of the project source files and generation of the database are divided into two phases: the analysis of individual program modules and generation of data about global symbols usage. Results of the analysis are saved in database files on the disk, which enables their later use in DA-C. You can choose between the unconditional analysis of all project files and the analysis of changed source files only, using *Start > Build database* and *Start > Update database* commands. *Start > Update database* optionally checks to ensure that the include files used in program modules are changed as well.

To build the database in our example use *Start > Build database* command, which makes the unconditional analysis of all project files and creates a database containing information about analyzed source code. Errors and Warnings detected during this operation are displayed in the Messages window as illustrated in [Figure 9.5](#) (for `Fibo.c` sample file):

Figure 9.5 DA-C Message Window

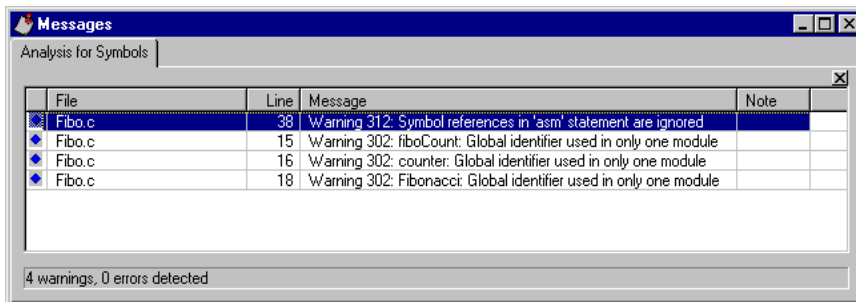

After the analysis of all project files, the new database file containing information about global symbols is constructed. Refer to the DA-C manual for more information on how symbol information can be used.

In the Project Manager's window of DA-C, select the **Logical View** Tab shown in [Figure 9.6](#) and unfold all fields. The project overview appears.

Synchronized Debugging Through DA-C IDE

Configuring DA-C IDE for Freescale Tool Kit

Figure 9.6 Logical View Tab

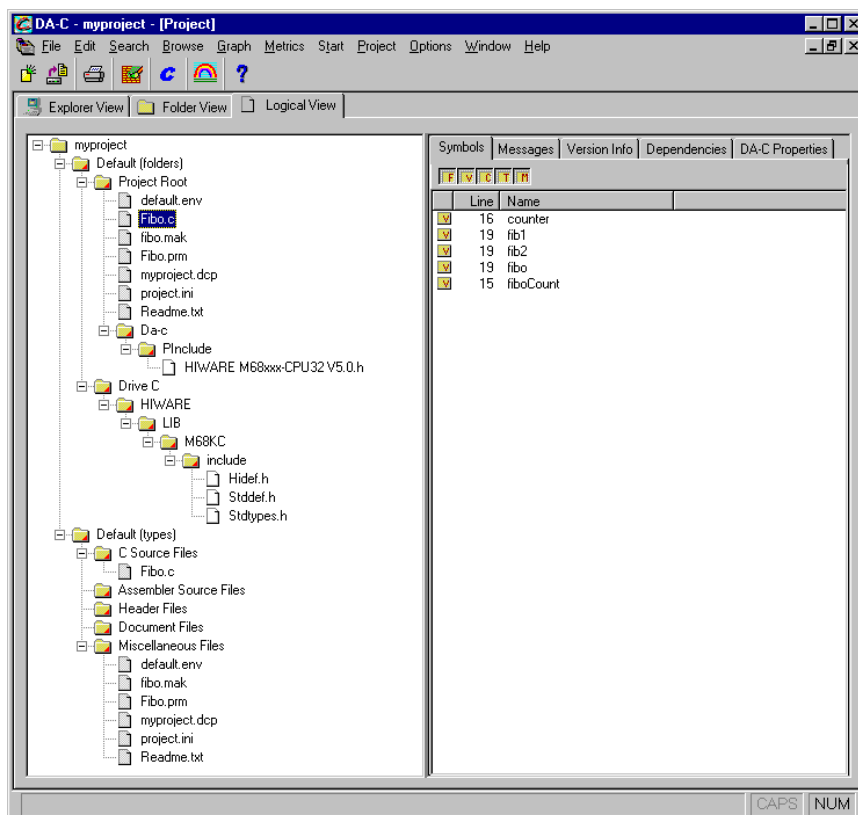

Double-click on `Fibo.c` file to open it.

Configuring The Tools

We will now configure the compiler and maker in the DA-C IDE. Procedures are defined in *Project > User Defined Actions* from the main menu of DA-C.

Compiler Configuration

In **Menu "Start" Actions**, click on **new** and fill in the **New Action** box with "C&compile", then press ENTER ([Figure 9.7](#)). In the **Toolbar** field, you can associate a bitmap with each tool, for example click on the **Picture** radio button and browse to the `\Bitmap` directory of your current DA-C installation and choose `Compiler.bmp`. This is a default bitmap delivered with the DA-C IDE. Here you are able to add your own bitmap.

Figure 9.7 DA-C Compiler Settings

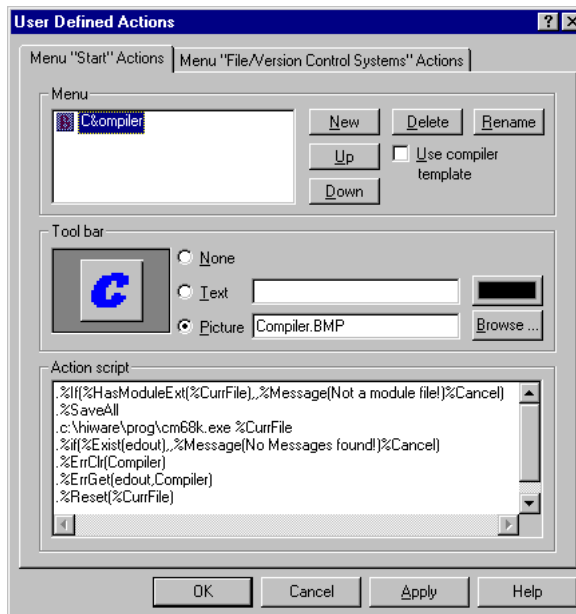

Now fill in the **Action Script** field in order to associate related compiler actions. Copy the following lines shown in [Listing 9.1](#) in the Action Script field and change the directory to where the compiler is located.

Listing 9.1 Script for Compiler Action Association

```

.%If(%HasModuleExt(%CurrFile),,%Message(Not a module file!)%Cancel)
.%SaveAll
.c:\Freescale\prog\cm68k.exe %CurrFile
.%if(%Exist(edout),,%Message(No Messages found!)%Cancel)
.%ErrClr(Compiler)
.%ErrGet(edout,Compiler)
.%Reset(%CurrFile)

```

Synchronized Debugging Through DA-C IDE

Configuring DA-C IDE for Freescale Tool Kit

Click on **OK** to validate these settings. Select the `Fibo.c` file. Click on the **Compiler** button (or from the main menu of DA-C select *Start > Compile*). This file is now compiled and the corresponding object file (`Fibo.o`) is generated.

Linker Configuration

In the same way, you can now configure the linker as illustrated in [Figure 9.8](#). In the **Menu "Start" Actions**, click on new and fill in the created **New Action** box with "&Link", then validate with ENTER. After setting the corresponding bitmap, copy the following lines shown in [Listing 9.2](#) in the **Action Script** field and change the directory to where the linker is located.

Listing 9.2 Script for Linker Action Association

```
+c:\Freescale\prog\linker.exe fibo.prm
.%if(%Exist(edout),, %Message(No Messages found!)%Cancel)
.%ErrClr()
.%ErrGet(edout)
```

Figure 9.8 DA-C Linker Settings

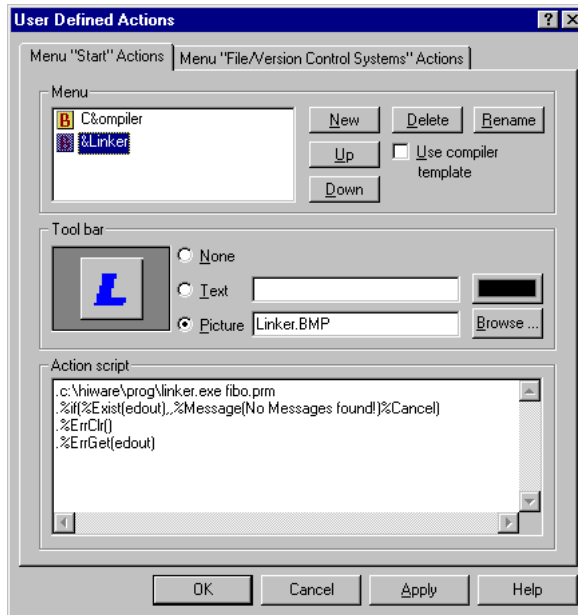

Maker Configuration

In the same way, you can now configure the maker as illustrated in [Figure 9.9](#). In the **Menu "Start" Actions**, click on new and fill in the created **New Action** box with "**&Make**", then press ENTER. After setting the corresponding bitmap, copy the lines from [Listing 9.3](#) in the **Action Script** field and change the directory to where the maker is located.

Listing 9.3 Script for Maker Action Association

```
+c:\Freescale\prog\maker.exe fibo.mak
.%if(%Exist(edout),,%Message(No Messages found!)%Cancel)
.%ErrClr()
.%ErrGet(edout)
```

Figure 9.9 DA-C Maker Settings

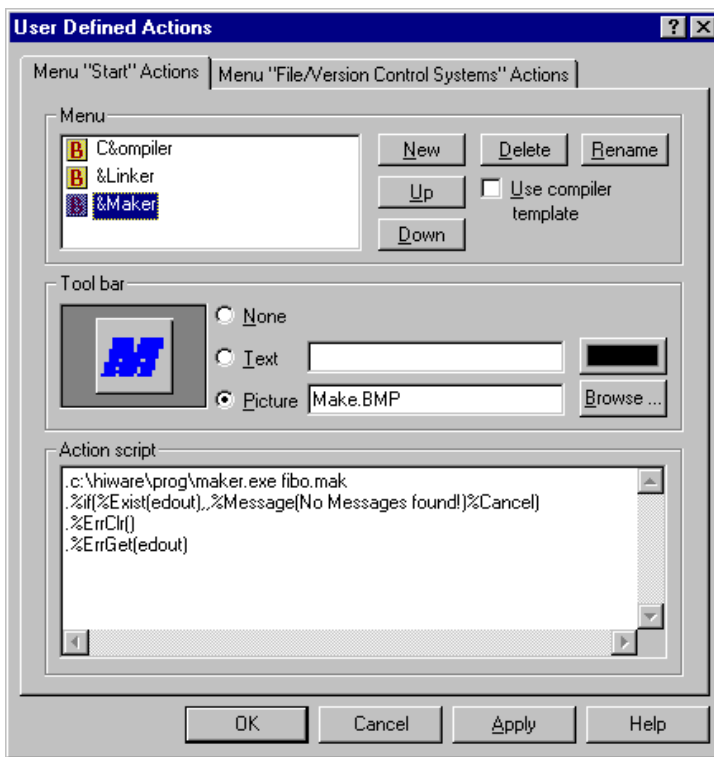

Debugger Interface

DA-C v3.5 currently integrates a DAPI interface (Debugging support Application Programming Interface). Through this interface DA-C is enabled to exchange messages with the Debugger. The advantages of this connection allow you to set or delete break points from within DA-C (in an editor, flow chart, graph, browser) and to execute other debugger operations. DA-C follows the debugger in its operation, since it is always in the same file and on the same line as the debugger. Thus, usability of both the DA-C and Debugger is increased. Some configurations are required in order to make efficient use of this Debugger Interface:

- Installation of communication DLL
- Configuration of Debugger properties
- Configuration of the Debugger project file

DA-C IDE and Debugger Communication

DA-C and the Debugger are both Microsoft Windows applications and communication is based on the DDE protocol, as shown in [Figure 9.10](#). The whole system contains:

- DA-C
- Debugger
- cDAPI interface implementation DLL - which is used by DA-C (Cdgen32.dll)
- nDAPI communication DLL (provided by DA-C), which is used by Debugger
- Debugger specific DLL for bridging its interface to debugging environment and DA-C's nDAPI (DAC . wnd)

Figure 9.10 Communication between DA-C IDE and Debugger

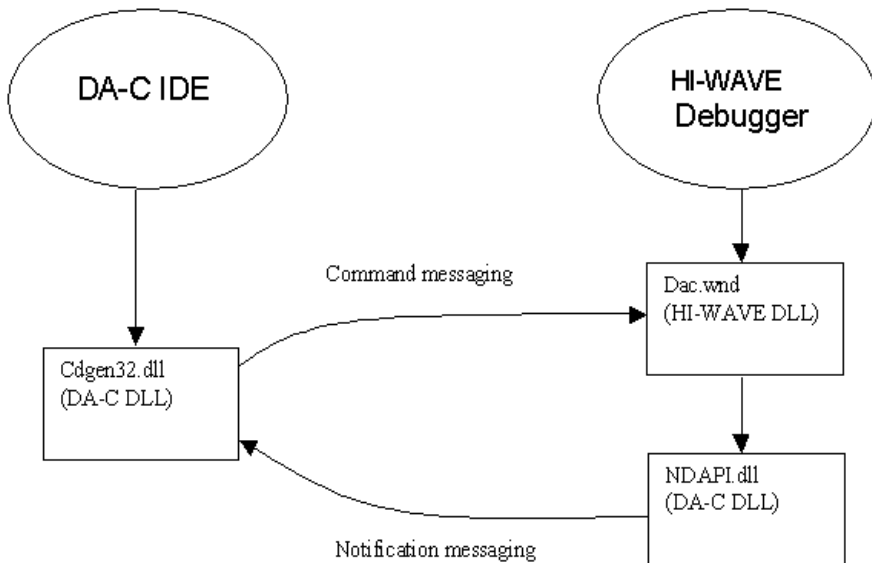

Communication DLL Installation

As described previously, the Debugger needs the nDAPI communication DLL (provided by DA-C IDE). This dll (called Ndapi.dll) is automatically installed during the Freescale Tool Kit installation. However, if you install a new release of DA-C you have to follow this procedure:

In the `\Program` directory of your DA-C installation, copy the `Ndapi32.dll` (`Ndapi32.dll` version 1.1 or later) and paste it in your current `Freescale\CodeWarrior for Microcontrollers V6.1\PROG` directory (where Debugger is located). Then rename it to `Ndapi.dll`.

Debugger Properties Configuration

In the DA-C main menu, choose *Options > Debugger*, the dialog box shown in [Figure 9.11](#) is opened.

Synchronized Debugging Through DA-C IDE Debugger Interface

Figure 9.11 DA-C Debugger Options Dialog Box

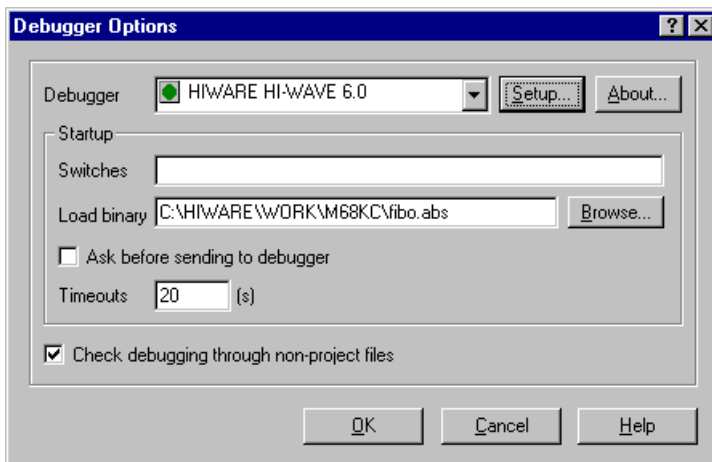

In the **Debugger** combo-box, select the corresponding debugger: **HI-WAVE 6.0**. Now specify the binary file to be opened: in our example we want to debug the `fibonacci.abs` file. Then click on the **Setup** button. The dialog box shown in [Figure 9.12](#) is opened.

Figure 9.12 DDE Debugger Setup Dialog Box

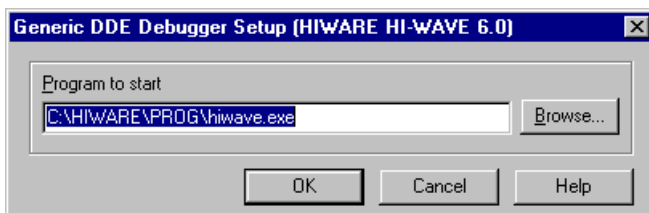

Specify the path to the `hiwave.exe` file or use the **Browse** button, then click on **OK**.

Debugger Project File Configuration

Before configuring the project file, close DA-C. Open Debugger (for example, from a shell) and select *File > Open Project* from the main menu bar. Select the `Project.ini` file from the currently defined working directory (in our case `C:\Program Files\Freescale\WORK\<processor>c\project.ini`). We will now add in the layout of the project the Debugger DA-C component (`dac.wnd`). In the Debugger select *Component > Open* from the main menu bar and choose **Dac**, as shown in [Figure 9.13](#).

Figure 9.13 DA-C Component Opening

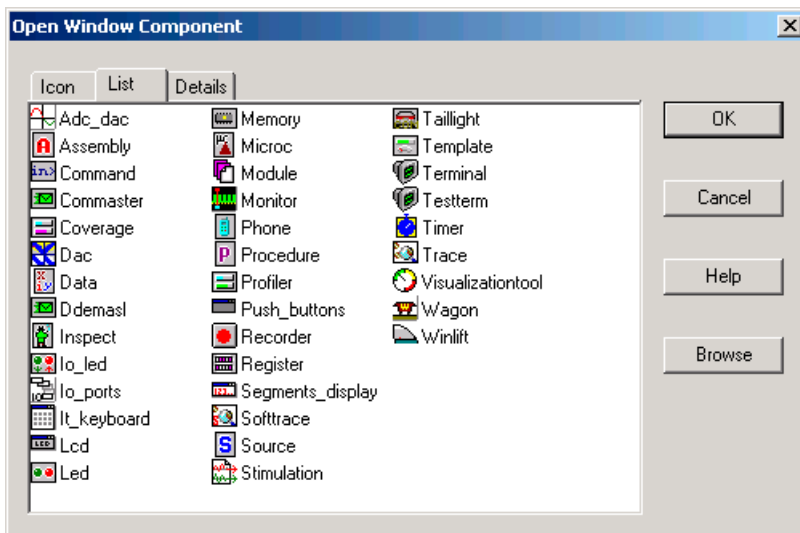

The Debugger DAC window, which is needed for communication with the DA-C IDE is now opened ([Figure 9.14](#)).

Figure 9.14 DA-C Window



You must save this configuration by selecting *File > Save Configuration* from the main menu of the Debugger. This component loads automatically the next time this project is called. Close the Debugger.

Synchronized Debugging

We can now test the synchronization between the DA-C IDE and Debugger. Run `DA-C.exe` and open the project previously created. Open `Fibo.c` if it's not already open. Right-click mouse button on `Fibo.c` source window and select **main** in the context menu. The cursor points to the `void main(void) {` statement. In the main menu from DA-C, select *Debug > Set Breakpoint* (or click on the corresponding button on the debug toolbar), the selected line is highlighted in red, indicating that a breakpoint has been set. Then select *Debug > Run*, the Debugger is now started and after a while stops on the specified breakpoint. Up to now, you can debug from the DA-C IDE with the toolbar, as shown in [Figure 9.15](#), or from the Debugger.

Synchronized Debugging Through DA-C IDE

Troubleshooting

Figure 9.15 DA-C toolbar



NOTE If changes are made to your source code, don't forget to rebuild the Database when generating new binary files to avoid misalignment between the Debugger and DA-C source positions.

Troubleshooting

This section describes possible trouble when trying to connect the Debugger with the DA-C IDE.

When loading the DAC component into the Debugger, if the message box shown in [Figure 9.16](#) is displayed, ensure that `ndapi.dll` is in the `\prog` directory of your current Freescale installation. If not, copy the specified DLL into this directory.

Figure 9.16 DA-C Component Loading Error Message



If the message box shown in [Figure 9.17](#) is displayed in the DA-C IDE, then the current name specified in the *Options > Debugger* main menu of DA-C doesn't match the debugger name specified in the Debugger.

Figure 9.17 DA-C Debugger Support Message

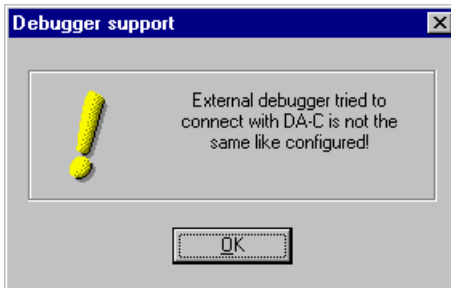

Open the setup dialog box in the Debugger by clicking on the DA-C Link component and choose *DA-C Link > Setup* from the main menu. The Connection Specification dialog box opens ([Figure 9.18](#)).

Figure 9.18 DA-C Connection Specification Dialog Box

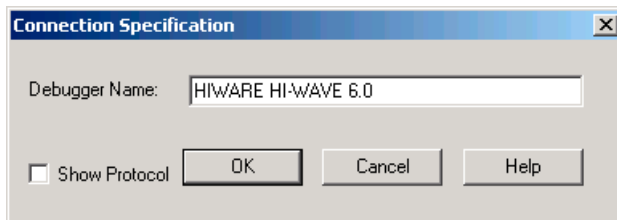

Compare the **Debugger Name** from this dialog box with the selected Debugger in the DA-C IDE (*Options > Debugger*), as shown in [Figure 9.19](#). Both must be the same.

Figure 9.19 DA-C Debugger Options Dialog Box

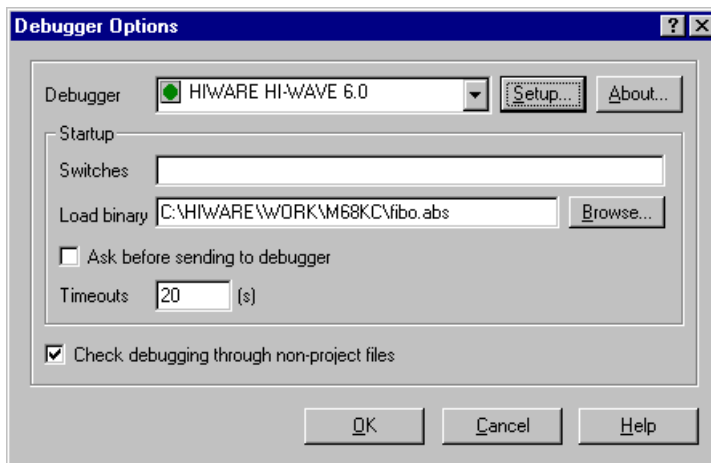

If the names are not the same, change the name in the Debugger "Connection Specification" and click **OK**. This establishes a new connection and saves the "Connection Specification" in the current `Project.ini` file in the section shown in [Listing 9.4](#).

Listing 9.4 DA-C Section in Project File.

```
[DA-C]
DEBUGGER_NAME=HI-WAVE 6.0
SHOWPROT=1
```



Synchronized Debugging Through DA-C IDE

Troubleshooting

Book II - HC08 Debug Connections

Book II Contents

Each section of the Debugger manual includes information to help you become more familiar with the Debugger, to use all its functions and help you understand how to use the environment. This book, the HC08 Debug Connections, defines the connections available for debugging code written for HC08 CPUs.

This book consists of the following sections:

- [Microcontroller Debugging First Steps](#)
- [HC08 Full Chip Simulation](#)
- [MON08 Interface Connection](#)
- [ICS MON08 Interface Connection](#)
- [HC08 P&E Multilink/Cyclone Pro Connection](#)
- [HC08 ICS P&E Multilink/Cyclone Pro Connections](#)
- [SofTec HC08 Connection](#)
- [HC08 FSICEBASE Emulator](#)



Book II Contents

Microcontroller Debugging First Steps

Since the initial steps for creating a project are similar, the following information provides an example of the first few steps of the New Project wizard that apply to creating an HC(S)08, HC08 or RS08 project. Debugging code using the CodeWarrior IDE requires that a project be created or exists, which specifies a connection that can be used to debug the code. This section guides you through the first steps toward code debugging with the CodeWarrior IDE and the following connections:

- [HCS08 Full Chip Simulation](#)
- [HCS08 Serial Monitor Connection](#)
- [ICS MON08 Interface Connection](#)
- [HCS08 P&E Multilink/Cyclone Pro Connection](#)
- [HC08 ICS P&E Multilink/Cyclone Pro Connections](#)
- [SofTec HCS08 Connection](#)
- [HCS08 Open Source BDM Connection](#)
- [RS08 Open Source BDM Connection](#)

NOTE The initial project creation steps for RS08 Connections mentioned in [Book IV - RS08 Debug Connections](#) are similar to the first steps mentioned in [Debugging First Steps Using the Wizard](#).

Technical Considerations

While they can be used to debug code, some of these connections have special technical considerations, as discussed in the following paragraphs.

Full Chip Simulation Considerations

The Full Chip Simulation (FCS) connection runs a complete simulation of all processor peripherals and I/O on the user's PC. No development board is required. Each derivative

has a totally different simulation engine to accurately simulate the memory ranges, I/O, and peripherals for any given derivative.

HC08 Serial Monitor Considerations

The 8/16 bit debugger (and then the CodeWarrior IDE) might be connected to HC08 hardware using the HC08 Serial Monitor connection. This connection supports communication specifications described in the application note from Freescale.

When the debugger runs the serial monitor connection, it can communicate and debug hardware running the serial monitor in full compliance with the Freescale Application Note specifications. Refer to this Application Note for communication hardware requirements.

ICS MON08 Interface Connection

In-Circuit Simulation (ICS) Mode is a P&E Microcomputer Systems mode of operation that is a hybrid between In-Circuit Debugging, and Full Chip simulation. In-Circuit Simulation, or ICS, mode simulates the CPU core instructions on the user's PC.

P&E Multilink/Cyclone Pro Considerations

To use the **P&E BDN-Multilink**, the drivers from P&E must be installed on the host computer. Use a parallel cable for communication between the **BDM-Multilink** and the host computer. The communication protocol between the **BDM-Multilink** and the host is handled by the target driver, which is automatically loaded with the connection.

ICS P&E Multilink/Cyclone Pro Considerations

In-Circuit Simulation Mode is a P&E Microcomputer Systems mode of operation that is a hybrid between In-Circuit Debugging, and Full Chip simulation.

SofTec HC08 Considerations

The 8/16 bits debugger (and then the CodeWarrior IDE) might be connected to HC08 hardware using the SofTec HC08.

When the debugger runs the **SofTec HC08** connection, it can communicate and debug HC08-based hardware connected through the SofTec in-circuit debugger/programmer units, that is:

SofTec Microsystems HC08 ISP Debuggers/Programmers (inDART Series) and Starter Kits (AK/SK/PK/ZK and newer Series).

Refer to the *inDART®-HC08 In-Circuit Debugger/Programmer for Motorola HC08 Family FLASH Devices User's Manual* from SofTec for communication hardware requirements and SofTec product installation.

Debugging First Steps Using the Wizard

To take the first steps toward debugging with the CodeWarrior IDE using the stationery Wizard:

1. Run the CodeWarrior IDE with the shortcut created in the program group.
2. Choose the menu *File > New Project* to create a new project from stationery.

The *Microcontrollers New Project* Wizard first screen appears.

Figure 10.1 New Window -Device and Connection Screen

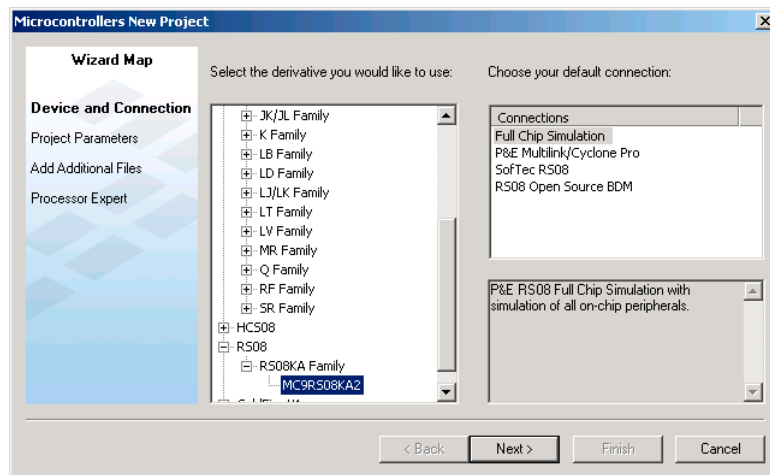

3. Expand the list and select the CPU derivative for your new project
4. After selecting derivative, choose connection from list that appears.
5. Click the **Next** button to proceed.

Microcontroller Debugging First Steps

Debugging First Steps Using the Wizard

Figure 10.2 Project Parameters Screen

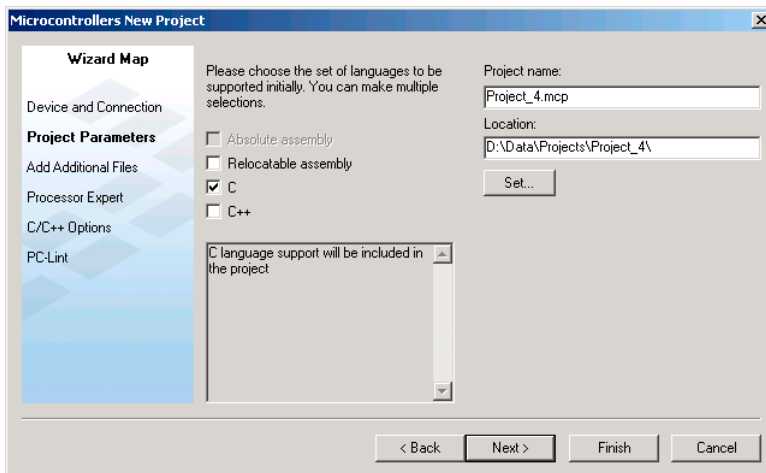

6. Choose the languages to be supported.
 - Assembly - If only Assembly is selected, you can later choose to use absolute/single file assembly application or relocatable assembly.
 - C - This sets up your application with an ANSI C-compliant startup code, doing initialization of global variables.
 - C++ - This sets up your application with an ANSI C++ startup code, doing global class object initialization.
7. Enter a project name and folder location to store project.
8. Click the **Next** button to proceed.

Figure 10.3 Add Files to Project Screen

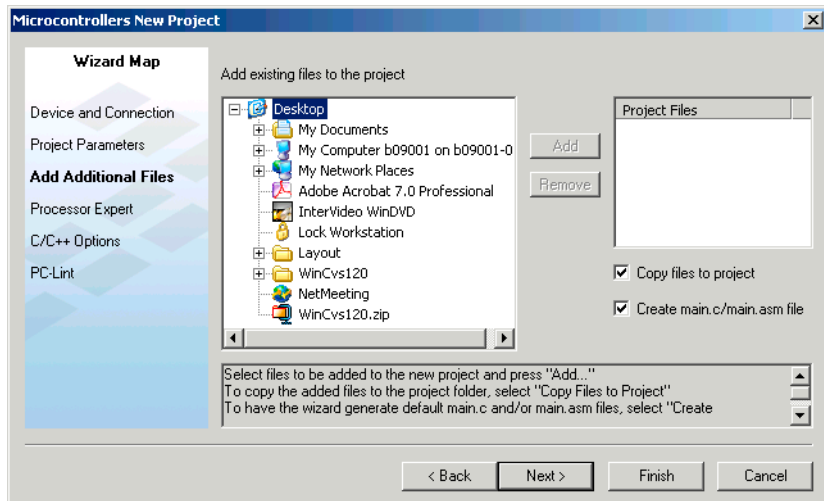

9. If needed, browse to and add existing files to project.
10. Click the **Next** button to proceed.

Microcontroller Debugging First Steps

Debugging First Steps Using the Wizard

Figure 10.4 Processor Expert Screen

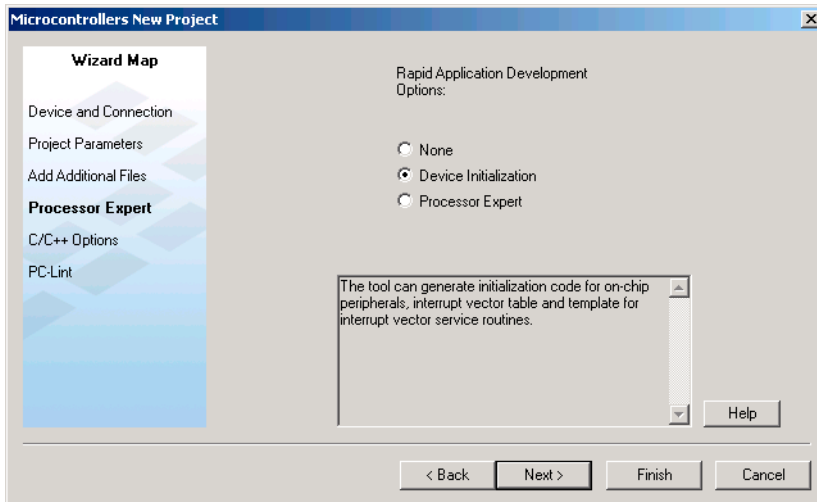

11. Select a Rapid Application Development option.
12. Depending on selected CPU derivative this may be last the screen. Click on the **Finish** button and the IDE opens.

Figure 10.5 C/C++ Options Screen

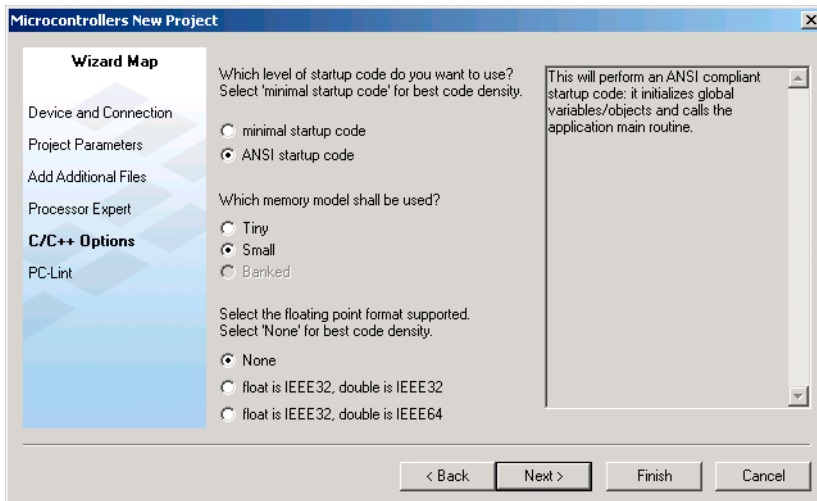

13. Depending on CPU derivative selected, additional screens may appear; select startup code, memory model, and floating point format.
 - Minimal startup code - This startup code initializes the stack pointer and calls the main function. No initialization of global variables is done, giving the user the best speed/code density and a fast startup time. But, the application code has to care about variable initialization. This makes this option **not** ANSI compliant, since ANSI requires variable initialization.
 - ANSI startup code - This performs an ANSI-compliant startup code that initializes global variables/objects and calls the application main routine.
 - Small - The Small memory model is best used if both the code and the data fit into the 64kB address space. By default all variables and functions are accessed with 16-bit addresses. the compiler does support banked functions or paged variables in this memory model, but all accesses have to be explicitly handled.
 - None - Do not use floating point for the HC08.
 - Float is IEEE32, double is IEEE32 - All float and double variables are 32-bit IEEE32 for the HC08.
 - Float is IEEE32, double is IEEE64 - Float variables are 32-bit IEEE32. Double variables are 64-bit IEEE64 for the HC08.
14. Click **Next** button to proceed

Figure 10.6 PC-Lint screen

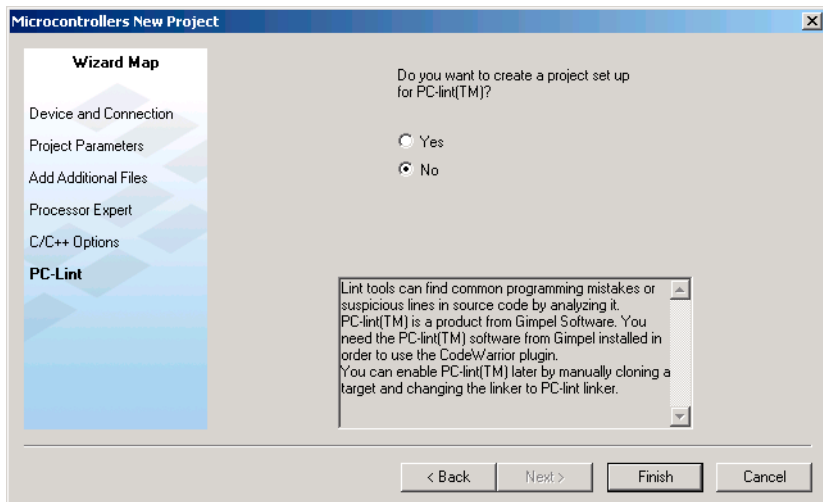

15. Depending on CPU derivative selected, choose whether or not to use PC-lint.
16. Click the **Finish** button.

Microcontroller Debugging First Steps

Switching Connections

17. In the IDE main window toolbar Project menu, choose *Project > Make*.
18. Now choose *Project > Debug* to start the debugger.

Figure 10.7 Your Project in Debugger Main Window

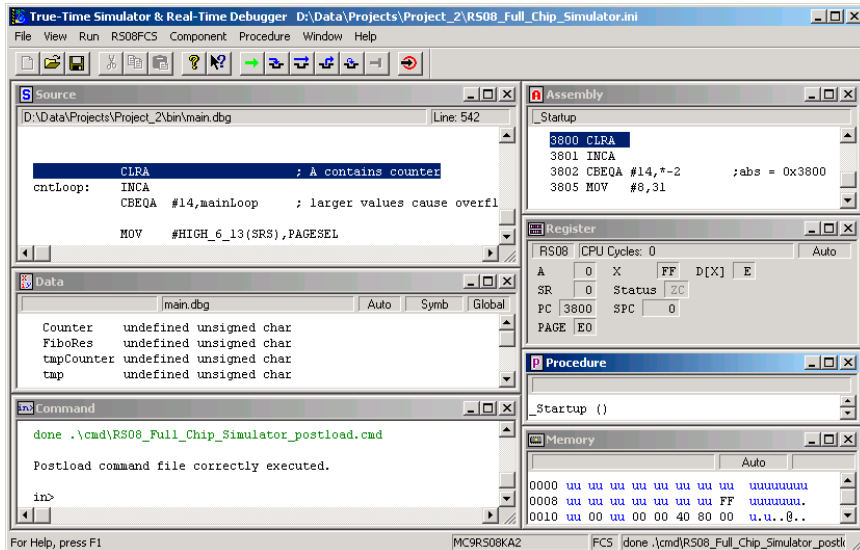

Switching Connections

It is possible to switch connections from within an existing debugging project. To switch connections, select *Set Connection* from the *Component* menu. The following information provides three examples of switching a connection.

CAUTION Normally, use the New Project or Change wizard to change the connections. This information is provided for advanced users only.

Loading the Full Chip Simulation Connection

Because there is no actual hardware involved in switching from another project, such as the SofTec in-Dart HCS08 connection, to the FCS connection, the process is simple. To load the FCS connection from within an existing project, take the following steps:

1. From the Debugger main menu, select *Component | Set Connection*, as shown below.

Figure 10.8 Component Menu

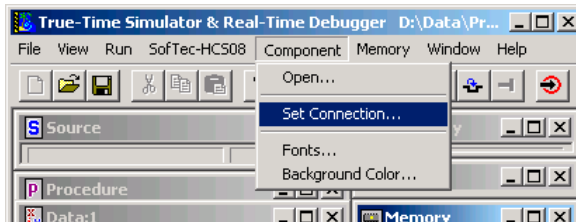

The Set Connection dialog box now appears.

Figure 10.9 Set Connection Dialog Box

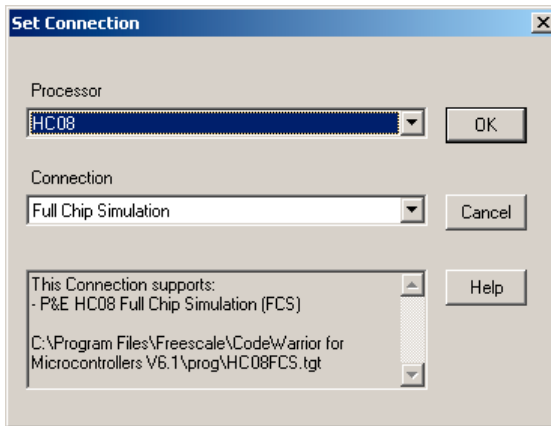

2. Select the Processor, for example, HC08 and the Connection as Full Chip Simulation.

Microcontroller Debugging First Steps

Switching Connections

3. Press the OK button. The Debugger main menu entry bar for the connection now changes to HC08FCS.

Figure 10.10 HC08 FCS Menu

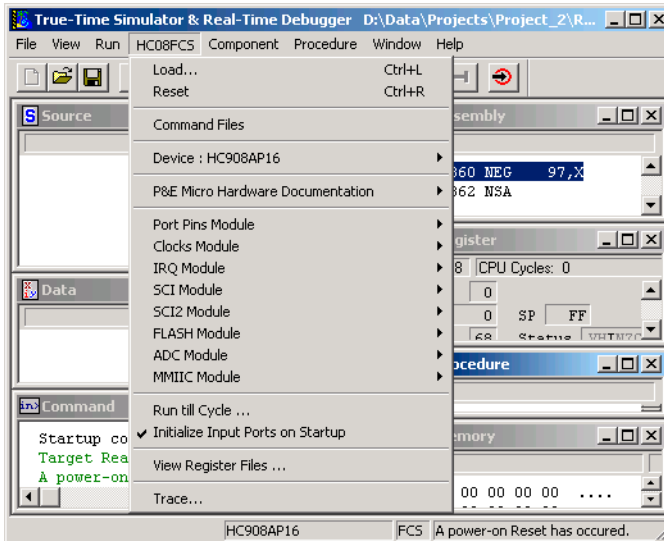

You have successfully switched connections to the FCS connection. The values and use of each HC08FCS menu entry is explained in the Full Chip Simulation chapter of this manual.

Loading the P&E Multilink/Cyclone Pro Connection

To load the Multilink/Cyclone Pro connection from within an existing project, take the following steps:

1. From the Debugger main menu, select *Component > Set Connection*, as shown below.

Figure 10.11 Component Menu

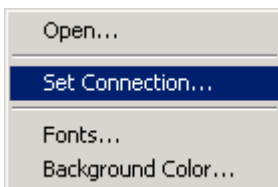

The Set Connection dialog box now appears.

Figure 10.12 Set Connection Dialog Box - Connection Menu

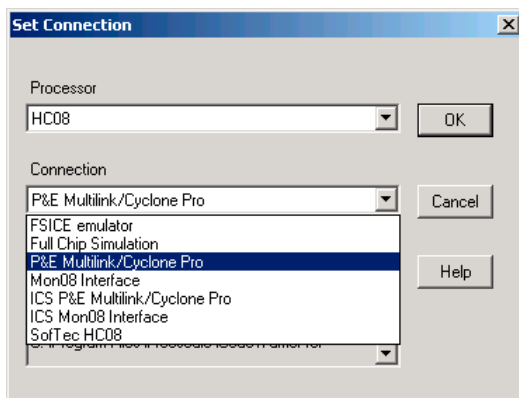

2. Within the Set Connection dialog box, press the Down Arrow button next to the Connection list box to display the list of available connections.
3. Select P&E Multilink/Cyclone Pro.

The Connection menu selection *P&E Multilink/Cyclone Pro* loads the proper drivers, etc. for the connection.

4. In the Debugger Main window, the Connection heading has been renamed **MultilinkCyclonePro**. Click on this heading to display its menu and list of selections.

Figure 10.13 MultilinkCyclone Pro Menu

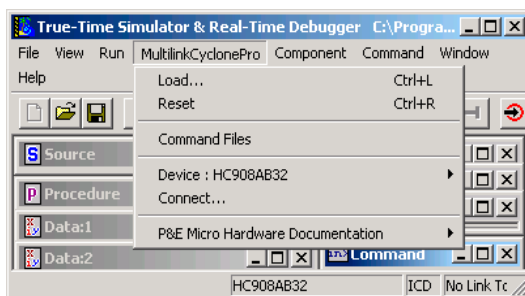

The menu selection *MultilinkCyclonePro > Load* loads an executable (.abs) file into connection memory. The file's program counter points to the first instruction of the startup section.

The menu selection *MultilinkCyclonePro > Reset* triggers a reset of the connection and executes the command file `reset.cmd`.

Microcontroller Debugging First Steps

Switching Connections

The menu selection *MultilinkCyclonePro > Connect* takes you to the P&E ICD connection manager dialog box.

Figure 10.14 P&E ICD Connection Manager Dialog Box

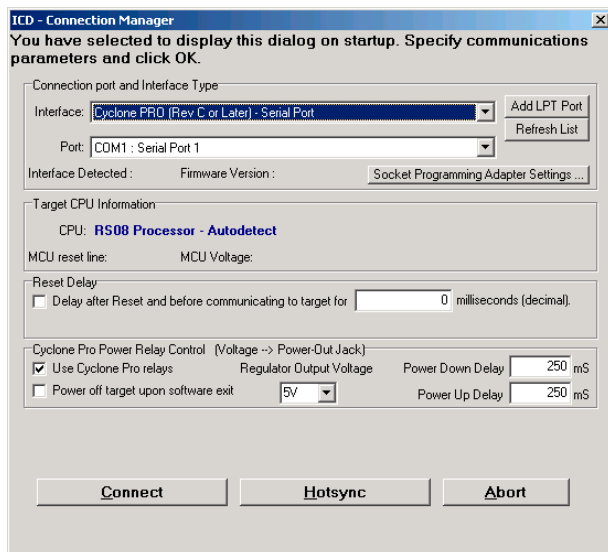

The menu selection *MultilinkCyclonePro > Command Files* takes you to the Command Files dialog box.

Figure 10.15 Command Files Window

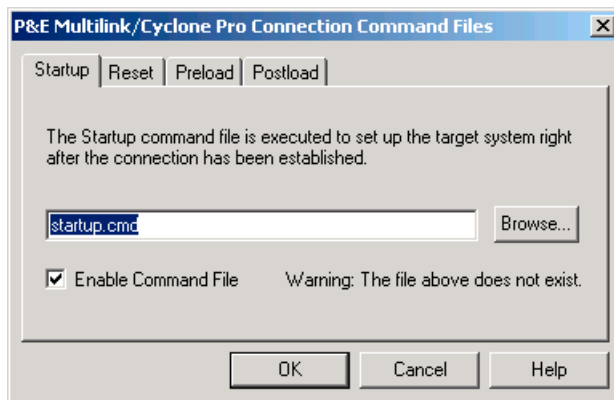

Loading the HC(S)08 or RS08 Open Source BDM Connection

To switch to either the HC(S)08 or RS08 Open Source BDM Connection follow these steps:

1. From the Debugger main menu, select *Component | Set Connection*, as shown below.

Figure 10.16 Component Menu

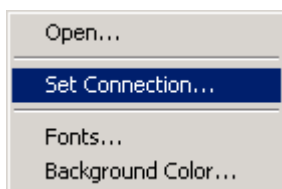

The Set Connection dialog box appears.

Figure 10.17 Set Connection Dialog Box

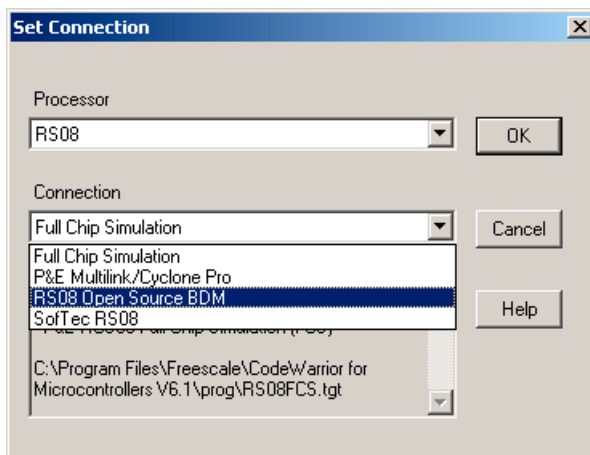

2. Select the Processor and Connection, for example, RS08 and RS08 Open Source BDM.

NOTE Select HC08 as the Processor to select HC08 Open Source BDM as the Connection.

Microcontroller Debugging First Steps

Switching Connections

3. Press the OK button.

The Debugger main menu entry bar for the connection now changes to RS08 Open Source BDM.

Figure 10.18 RS08 Open Source BDM Menu

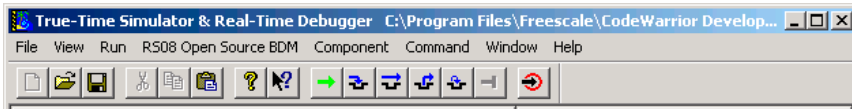

You have successfully switched connections.

HC08 Full Chip Simulation

Full Chip Simulation (FCS) connection runs a complete simulation of all processor peripherals and I/O on the user's Personal Computer. Because of this it does not require an MCU development board to be connected to your PC. Each derivative has a totally different simulation engine to accurately simulate the memory ranges, I/O, and peripherals for a given derivative (for more information on selecting a specific derivative, see the [Select Device Option](#) section below.

Configuration Procedure

Choose the Full Chip Simulation option from the Set Connection dialog box. See [Figure 11.1](#).

Figure 11.1 Set Connection Dialog Box - Full Chip Simulation Option

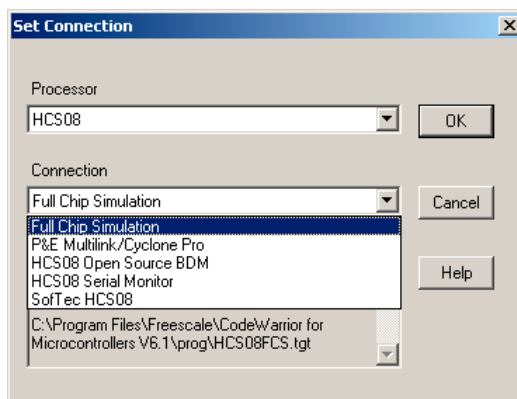

When you have selected this option, the Connection list menu becomes the HCS08FCS Menu, and appears as shown in [Figure 11.2](#).

HC08 Full Chip Simulation Configuration Procedure

Figure 11.2 Connection (HCS08FCS) List Menu

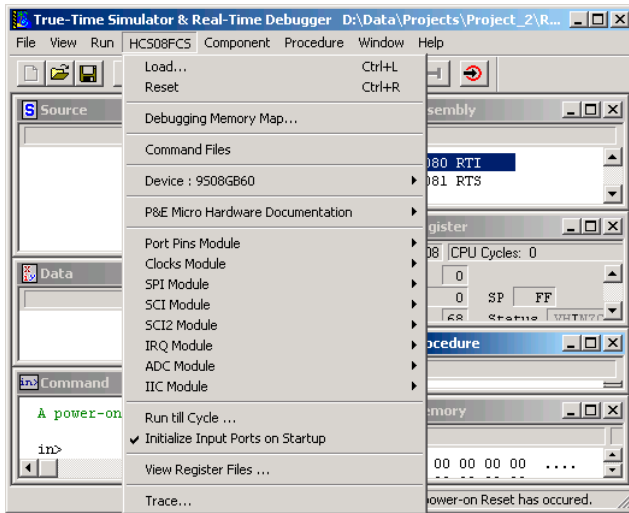

Select Device Option

The Device option on the HC08FCS menu allows you to select the particular Freescale processor that you wish to use. If you choose Device from the HC08FCS menu, additional extended menus open that allow you to select the family and device type of the MCU that you are using. See [Figure 11.3](#).

Figure 11.3 Device Option Extended Menus

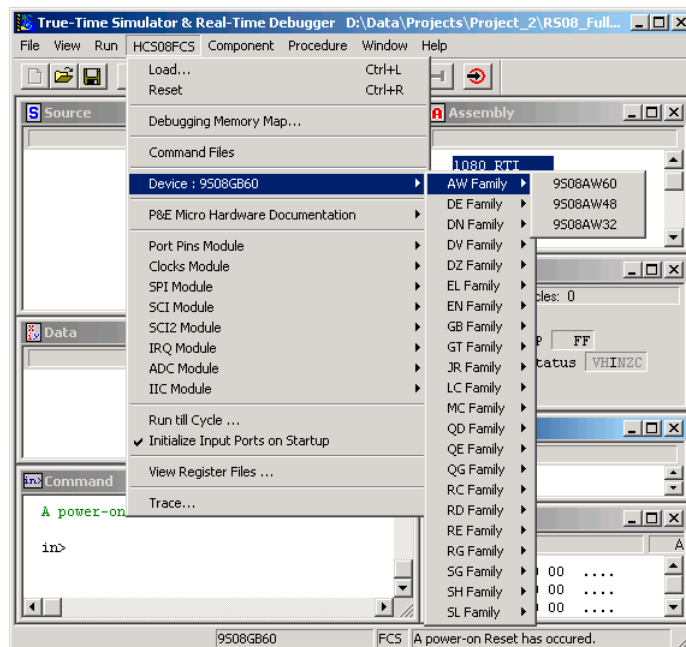

Full Chip Simulation Module Commands

The HCS08FCS Menu contains the Full Chip Simulation commands for the modules that have specialty commands associated with them for a chosen device. For more information about specific module commands, refer to the Full Chip Simulation section describing the particular module.

Run Till Cycle Option

The Run Till Cycle command lets you begin execution of code, and stop execution when the specified cycle count is reached. Note that the parameter given is not the number of cycles that executed, but rather the total cycle count of the simulator (displayed in the Register Window).

HC08 Full Chip Simulation

Configuration Procedure

This command is extremely useful for verifying specific timings of a given event, running until a given event is complete, or just before it completes to enable stepping through the event or any application where cycle-timed execution is desired.

Initialize Input Ports On Startup

The Initialize Input Ports on Startup option initializes all simulated inputs to \$00 when the software is started, or when the Device Mode or Debug Target is switched. This initialization doesn't apply to a **reset** command. When you change this option, the new state takes effect the next time HiWave is started (or Device Mode/Debug Target is switched).

View Register Files Option

The *View Register Files* option in the HCS08FCS Menu also gives you the option of running the register file viewer/editor. If register files are available for the device that you have chosen, the *Choose a Register Block* dialog box (see [Figure 11.4](#)) is opened. You may also open it by entering the R command in the Command Window command line.

Figure 11.4 Choose A Register Block Dialog Box

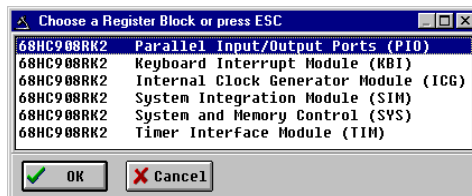

If register files have been installed on the host computer, selecting a block brings up the Register Block register listing in the Timer Interface Module dialog box (see [Figure 11.5](#)), which shows a list of the associated registers, their addresses, and their descriptions. This begins interactive setup of system registers such as I/O, timer, and COP watchdog.

Figure 11.5 Timer Interface Module Dialog Box - Register Listing

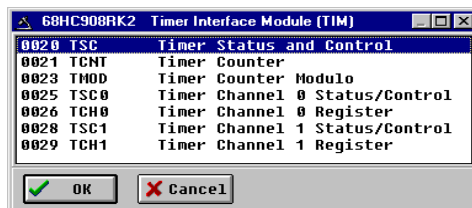

Selecting a file in this dialog box brings up the Register Window (see [Figure 11.6](#)), which displays the values and significance for each bit in the register. The registers can be

viewed and their values modified, and the values can be stored back into debugger memory.

Figure 11.6 Register Window

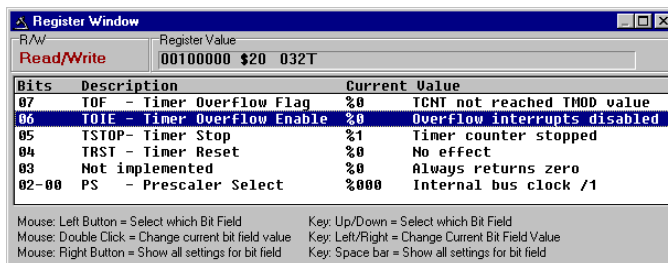

Peripheral Modules Options

If you have selected a device (see [Select Device Option](#)), the HCS08FCS Connection Menu displays a list of peripherals (Modules) for the device you have chosen. The Module's associated commands appear as extended menus.

Figure 11.7 HCS08FCS Menu - ADC Module Extended Menu Options

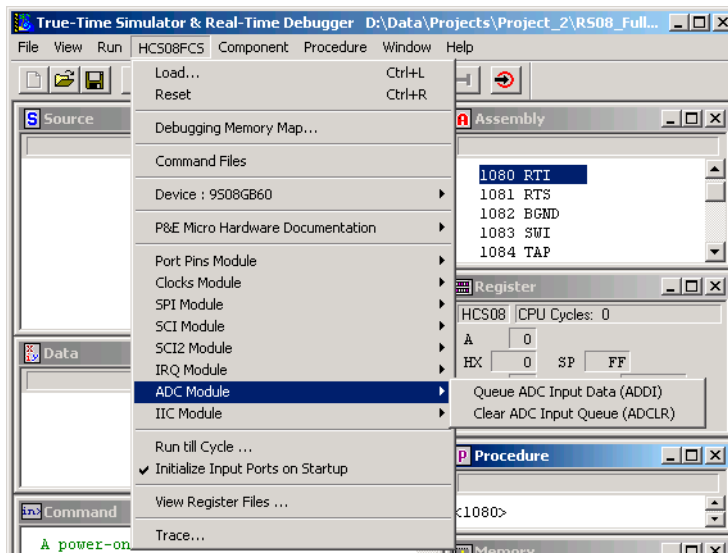

Placing your mouse over a peripheral opens an extended menu which lists its associated commands. Click on a command to execute that command.

ADC Module Option

In Full Chip Simulation Mode (FCS), this option lets you simulate all the functionality of the Analog to Digital Conversion (ADC) module including data input on all ADC channels, flag polling, interrupt operation as well as the bus and CGMXCLK reference clock sources. FCS mode uses the buffered input structure to simulate the ADC inputs. The user can queue up to 256 data values. To queue the ADC Input Data, use the **ADDI** command in the command prompt. If the data parameter is given, the value is placed into the next slot in the input buffer. Otherwise, if no parameter is provided, a window is displayed with the input buffer values. Input values can be entered while the window is open. An arrow points to the next value to be as input to the ADC. The conversion takes place after a proper value is written to the ADC Status and Control register. Once the conversion occurs, the arrow moves to the next value in the ADC Buffer.

Figure 11.8 ADC IN Buffer Display

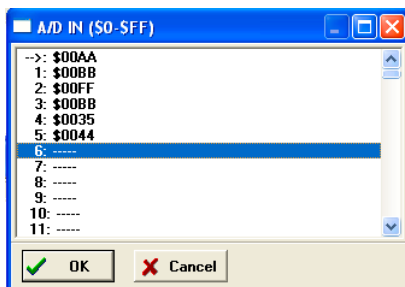

At any point, the ADCLR command can be used to flush the input buffer for the ADC simulation.

After the conversion is complete, the first queued value is passed from the data buffer into the ADC data register. It can be observed in the memory window by displaying the memory location corresponding to the ADC data register.

Figure 11.9 Memory Component Window

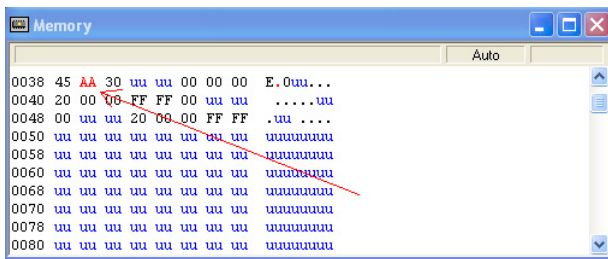

Conversion completion sets the appropriate flag. If you enable interrupts, the Program Counter changes flow to the interrupt routine (as defined in the vector space of the MCU).

For more information on ADC configuration, refer to the Freescale Manual for your microprocessor.

ADC User Commands

The following ADC commands are available on the HC08 processor in Full Chip Simulation mode.

ADDI Command

The ADDI command allows the user to input the data into the ADC converter. If a data parameter is given, the value is placed into the next slot in the input buffer. Otherwise, if no parameter is given, a window appears with the input buffer values. Input values can be entered while the window is open. An arrow points to the next value to be sent to the ADC. The maximum number of input values is 256 bytes.

Syntax

```
>ADDI [<n>]
```

Where:

<n> The value to be entered into the next location in the input buffer.

Example

```
>ADDI $55
```

Set the next input value to the ADDI to \$55

```
>ADDI
```

Pull up the data window with all the input values.

ADCLR Command

Use the ADCLR command to flush the input buffer for ADC simulation. This resets the input data buffer and clears out all values. Notice that if the ADC is currently using a value, this command does not prevent the ADC from using it. See ADDI Command for information on how to access the input buffer of the ADC interface.

Syntax

```
>ADCLR
```

Example

```
>ADCLR
```

Clear the input buffer for ADC simulation.

Clock Generation Module Option

In Full Chip Simulation Mode, this option lets you simulate all functionality of the Clock Generation Module (CGM), including:

- Phase Locked Loop (PLL) generation
- Automatic lock detection
- Interrupt
- Acquisition
- Tracking
- Flag polling

Full Chip Simulation mode uses simulated External Oscillator Frequency change command (XTAL) to allow the user to input the desired XTAL value. To check the current value of the External Oscillator, Bus Frequency and CGMXCLK Frequency, open the HCS08FCS menu, then select *Clocks Module > Show MCU Clocks*.

Figure 11.10 Show MCU Clocks Menu

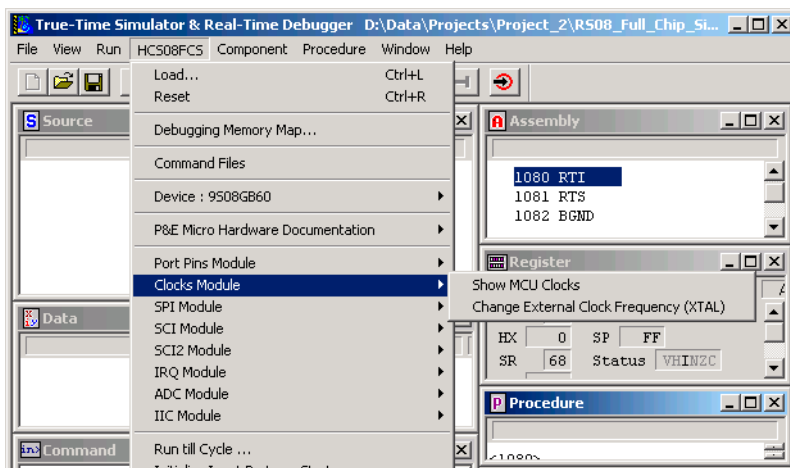

Once you select the MCU Clocks Menu, the Cycles window containing all of the above-mentioned Clock Frequencies appears.

Figure 11.11 Frequency Display

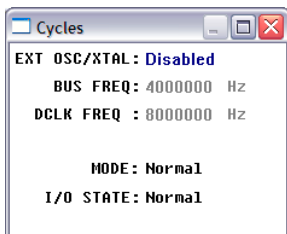

Once the CGM is properly configured, the user can monitor the status of the PLL by polling the corresponding flag. If PLL interrupt is enabled, FCS jumps to an appropriate subroutine as long as the interrupt vector is properly defined. To observe the flag going up as a result of the corresponding CPU event, situate your Memory Window on the memory location of the CGM Status and Control register.

Figure 11.12 Memory Window

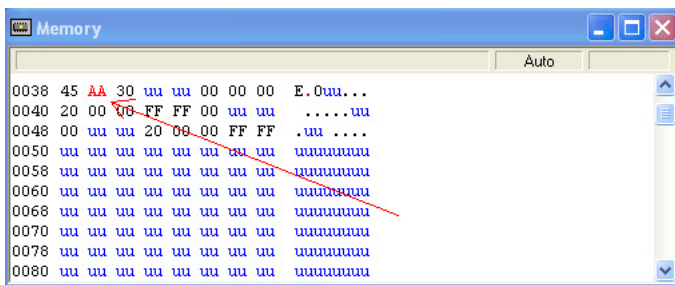

For more information on how to properly configure Clock Generation, refer to the reference manual corresponding to the microprocessor that you are using.

CGM Commands

The following Clock Generation commands are available on the HC08 processor.

XTAL Command

Use the XTAL command to change the value of the simulated external oscillator. This in turn affects the input to the PLL/DCO, and therefore the bus frequency. The P&E simulator is a cycle-based simulator, so changing the XTAL value does not affect the speed of simulation; it does, however, affect the ratio in which peripherals receive cycles.

HC08 Full Chip Simulation

Configuration Procedure

Certain peripherals that run directly from the XTAL run at different speeds than those that run from the bus clock.

Syntax

```
>XTAL <n>
```

Where:

n, by default, is a hexadecimal number, representing the simulated frequency of an external oscillator. Adding the suffix “t” to the n parameter forces the input value to be interpreted as base 10.

Example

```
>XTAL
```

Brings up an input window. The default base for this input value is 10. However, this value can be forced to a hexadecimal format by adding the suffix “h”.

High-Resolution PWM Module

In Full Chip Simulation Mode, this option lets you simulate all functionality of the High Resolution PWM (HRP) module, including:

- pulse width modulation
- flag polling
- interrupt enabled mode of operation
- variable period and dead time insertion
- shutdown input for fast disabling of outputs

To ensure that the HRP firmware is functioning as expected, the user can observe the toggling of I/O pins that are multiplexed with the HRP module. To do that, the HRP module has to be configured for the desired period with the enabled output on corresponding TOP and BOT pins. The Memory Window displays the address of the register corresponding to the appropriate I/O port.

Figure 11.13 Memory Component Window

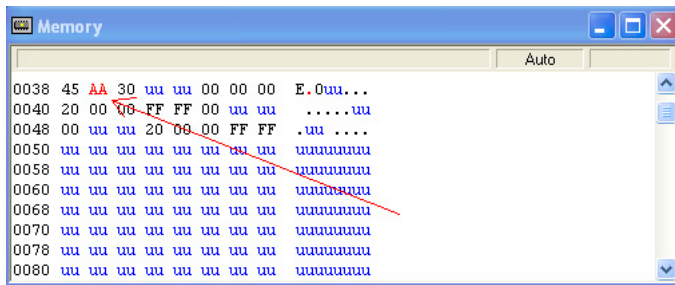

If you enable the Shutdown pin on the HRP module, you can observe the SHTIF Flag via the Memory window once the Shutdown event takes place. If you enable the HRP interrupt, the FCS jumps to an appropriate subroutine as long as the HRP interrupt vector is properly defined. To observe the SHTDWN Interrupt Flag going up as a result of the corresponding CPU event, situate your Memory Window on the memory location of the HRP Control register.

To observe the accuracy of the HRP module operation, the user can observe the number of CPU cycles that it takes for the event to occur. The cycle counter is only incremented as the user steps through the code. To determine the exact amount of cycles over which the event occurs, one can either observe the cycle display in the Register Window or use the built in simulation commands. To display the current number of cycles in the Command window, use the CYCLES <n>, where <n> is the new cycle value. If the number of cycles has been pre-calculated, use CYCLE 00 to reset the number of cycles and GOTOCYCLE <n> to run through the code until the place where the expected event occurs.

Figure 11.14 Register Window With Cycles Display

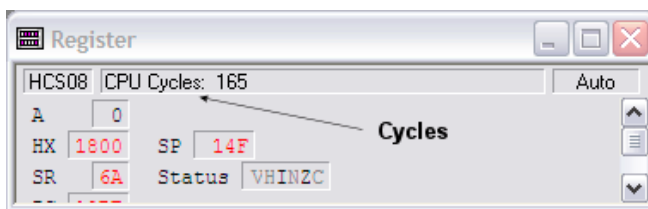

High-Resolution PWM Commands

The following commands are available for High-Resolution Pulse-Width Modulation on the M68HC08 processor.

CYCLES Command

The CYCLES command changes the value of the cycles counter. The cycles counter counts the number of processor cycles that have passed during execution. The Cycles Window shows the cycle counter. The cycle count can be useful for timing procedures.

Syntax

```
>Cycles <n>
```

Where:

<n> Integer value for the cycles counter

Examples

```
>CYCLES 0
```

Reset cycles counter

```
>CYCLES 1000
```

Set cycle counter to 1000.

GOTOCYCLE Command

The GOTOCYCLE command executes the program in the simulator beginning at the address in the program counter (PC). Execution continues until the cycle counter is equal to or greater than the specified value, until a key or the Stop button on the toolbar is pressed, until it reaches a break point, or until an error occurs.

Syntax

```
>GOTOCYCLE <n>
```

Where:

<n> Cycle-counter value at which the execution stops

Example

```
>GOTOCYCLE 100
```

Execute the program until the cycle counter equals 100.

SHTDWN Command

When you enable the Shutdown pin in the High Resolution PWM Control Register (HRPCTRL), you can use this command to change the state of the SHTDWN pin. The Shutdown pin then takes on this state after the simulator executes the next step. If interrupts are enabled, issuing a SHTDWN 0 command triggers an interrupt that is cleared until the SHTIF bit is cleared in the HRPCTRL and a SHUTDWN 1 command is issued. Note that this interrupt is both edge and level sensitive.

If the SHTDWN pin is not enabled in the HRPCTRL, this command has no effect.

Syntax

```
>SHTDWN <n>
```

Where:

<n> = 1 or 0, representing the state of the SHTDWN pin on the next simulated clock cycle.

Example

```
>SHTDWN 0
```

Change the state of the SHTDWN pin to 0.

Input/Output (I/O) Ports Module

In Full Chip Simulation Mode (FCS), this option lets you simulate all input and output functionality of the Input/Output (I/O) Ports module. FCS mode uses a set of designated commands to simulate the input and output activity on corresponding I/O port pins. To define an input state of the specific port, write the `INPUT <x> <n>` command in the Command line window. The `<x>` represents the corresponding I/O port, while the `<n>` stands for the input value to write to this port. At the same time, you can use the `INPUTS` command to bring up the Simulated Port Inputs for all general I/O ports. It displays the current simulated values to all applicable input ports. See [Input/Output Ports Commands](#) for more information about the various forms of this command.

HC08 Full Chip Simulation Configuration Procedure

Figure 11.15 Simulated Port Inputs Dialog Box

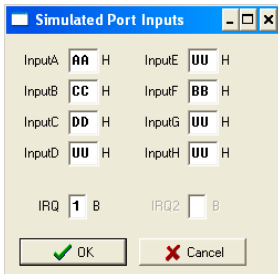

Using the Simulated Port Inputs dialog box, the input value to any I/O port can be reconfigured. The INPUTS command can be used to reconfigure the output values on any relevant I/O port. The manipulation of I/O port pins can be observed in the Memory Window.

Figure 11.16 Memory Component Window

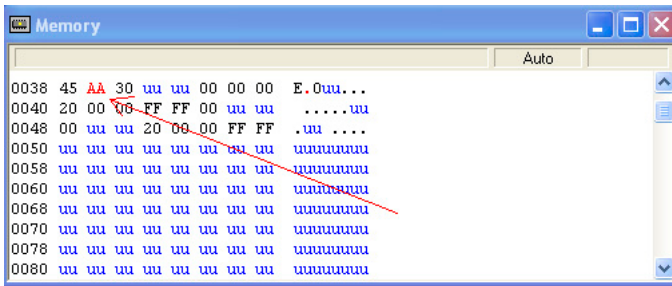

Note that if the regular I/O pins are multiplexed to be used by a different MCU Module, they might not be available for general I/O functionality. For more information on how to properly configure I/O pins, refer to the Freescale user manual corresponding to the microprocessor that you are using.

Input/Output Ports Commands

Use the following commands for general IO port manipulation.

INPUT<x> Command

The INPUT<x> command sets the simulated inputs to port <x>. The CPU reads this input value when port <x> is set as an input port.

Syntax

```
>INPUT<x> <n>
```

Where:

<x> is the letter representing corresponding port

<n> Eight-bit simulated value for port <x>

Example

```
>INPUTA AA
```

Simulate the input AA on port A.

INPUTS Command

In Full Chip Simulation and CPU-Only Simulation mode, the INPUTS command opens the Simulated Port Inputs dialog box shown in [Figure 11.17](#) below. The user may then use this box to specify the input states of port pins and IRQ.

Figure 11.17 Simulated Port Inputs Dialog Box

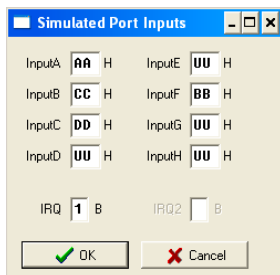

When using In-Circuit Simulation mode, the INPUTS command shows the simulated input values to any applicable port.

Syntax

```
>INPUTS
```

Example

```
>INPUTS
Show I/O port input values.
```

External Interrupt Module

In Full Chip Simulation (FCS) Mode, this option lets you simulate the input, flag polling and interrupt functionality of the External Interrupt (IRQ) module. The FCS Mode uses the INPUTS command to let the user monitor and change the simulated value of the IRQ input pin state. See the documentation for [Keyboard Interrupt Commands](#) for more information about the various forms of this command. When the user enters the INPUTS command into the command line prompt, the Simulated Port Inputs window appears. In addition, the user can directly modify the state of the IRQ pin using the IRQ <n> command (documented below).

The occurrence of the IRQ event sets the appropriate flag in the corresponding IRQ register. The user can poll the IRQ flag if the Polling Mode is simulated. In the Interrupt Mode, the simulator branches to an appropriate interrupt subroutine as long as the IRQ interrupt vector is properly configured. For more information on IRQ configuration, refer to the Freescale user manual for your microprocessor.

Following the IRQ event, you can observe the IRQ Flag going up in the IRQ Status and Control register.

Figure 11.18 Memory Component Window

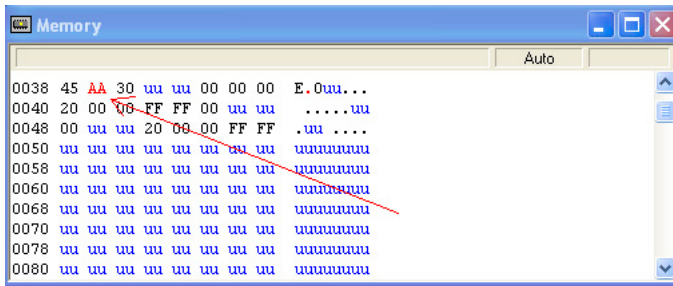

IRQ Commands

The following interrupt request commands are available in FCS mode on the HC08 processor.

INPUTS Command

In Full Chip Simulation and CPU-Only Simulation mode, the INPUTS command opens the Simulated Port Inputs dialog box shown in [Figure 11.19](#). The user may then use this box to specify the input states of port pins and IRQ.

Figure 11.19 Simulated Port Inputs Dialog Box

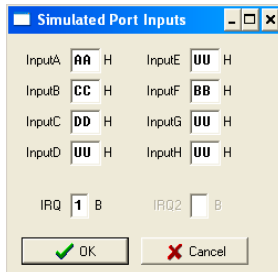

When using In-Circuit Simulation mode, the INPUTS command shows the simulated input values to any applicable port.

Syntax

```
>INPUTS
```

Example

```
>INPUTS
```

Show I/O port input values.

NOTE The IRQ pin state can be directly manipulated with the IRQ command. For example, `IRQ 1` simulates a high state on the IRQ pin; likewise, `IRQ 0` simulates a logic-low state on the IRQ pin.

Keyboard Interrupt Module

In FCS Mode, this module simulates all functionality of the Keyboard Interrupt (KBI) module including the edge-only, edge and level interrupt, and flag polling modes of operation. FCS mode uses simulated port inputs to trigger the KBI event from the proper I/O port pin. To define an input state of the specific port, write the `INPUT<x> <n>` command in the Command line window. The `<x>` represents the corresponding I/O port, while `<n>` stands for the input value to write to this port. At the same time, you can use

HC08 Full Chip Simulation

Configuration Procedure

the `INPUTS` command to bring up the Simulated Port Inputs for all general I/O ports. It displays the current simulated values to all applicable input ports. See [FCS Timer Interface Module Commands](#) for more information about the various forms of this command.

Figure 11.20 Simulated Port Inputs Dialog Box

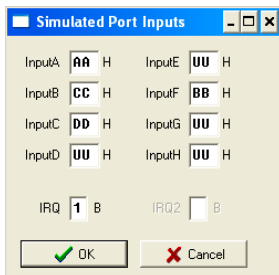

Use the Simulated Port Inputs dialog box to reconfigure the input value to any I/O port. To trigger the event, manipulate the inputs to the port in the appropriate manner, depending on whether the KBI is configured for edge-only or edge and level. Once the KBI event takes place, the KEYF Flag bit, which is a part of the Keyboard Status and Control register, can be observed in the Memory Window.

Figure 11.21 Memory Component Window

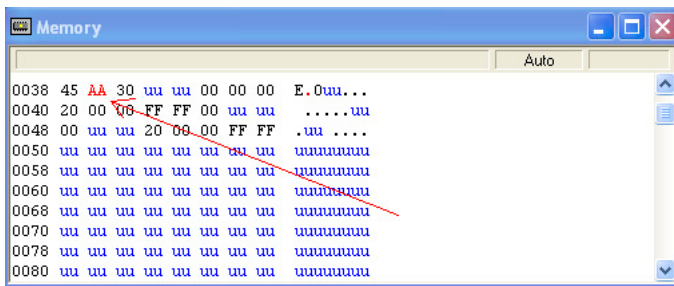

The user is able to poll the KBI Interrupt Pending flag if the polling Mode is simulated. In Interrupt Mode, the simulator branches to an appropriate interrupt subroutine as long as the KBI interrupt vector is properly configured. For more information on KBI configuration, refer to the Freescale user manual for your microprocessor.

Keyboard Interrupt Commands

Use the following Keyboard interrupt commands while in full chip simulation mode.

INPUT<x> Command

The INPUT<x> command sets the simulated inputs to port <x>. The CPU reads this input value when port <x> is set as an input port.

Syntax

```
>INPUT<x> <n>
```

Where:

<x> is the letter representing corresponding port

<n> Eight-bit simulated value for port <x>

Example

```
>INPUTA AA
```

Simulate the input AA on port A.

INPUTS Command

In Full Chip Simulation and CPU-Only Simulation mode, the INPUTS command opens the Simulated Port Inputs dialog box shown in [Figure 11.22](#). You may then use this box to specify the input states of port pins and IRQ.

Figure 11.22 Simulated Port Inputs Dialog Box

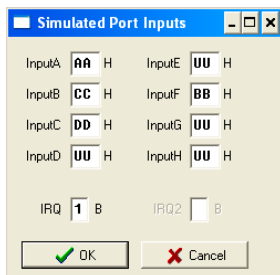

When using In-Circuit Simulation mode, the INPUTS command shows the simulated input values to any applicable port.

Syntax

```
>INPUTS
```

Example

```
>INPUTS
Show I/O port input values.
```

Multi-Master Inter-Integrated Circuit Module

In Full Chip Simulation Mode, this module simulates all functionality of the Multi-Master Inter-Integrated Circuit (MMIIC) module including:

- Flag polling
- Interrupt enabled mode
- Transmission and reception of external data
- Master and slave modes of operation
- START and STOP signal generation detection
- Acknowledge bit generation detection

The FCS mode uses the buffered input/output structure to simulate MMIIC inputs. The user can queue up to 256 data bytes into the input buffer. The output buffer of the USB module can also hold 256 output bytes. To queue the MMIIC Input Packets, use the `IICDI <. . . >` command in the command prompt. If the MMIIC packet parameters are properly defined, the packet is placed into the next slot in the input buffer. Otherwise, if no parameters are provided, an MMIIC Input Buffer window is displayed. Different MMIIC packet parameters can be entered while the window is open including START, STOP, ACK, NACK and data bytes. An arrow points to the next byte to be used next as input to the MMIIC. The data from the MMIIC input buffer is written to the MMIIC module registers once the MMIIC module is turned on and properly configured for receiving data from an external MMIIC device. Once the simulation of the data transmission is over, the arrow moves to the next value in the MMIIC Input Buffer.

Figure 11.23 IIC Input Buffer Display

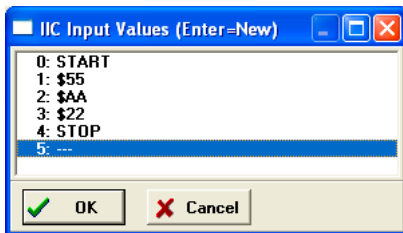

The MMIIC data input/output log buffer simulation allows the user to gain access to the past 256 MMIIC data bytes that have been shifted in and out of the module. To bring up the IIC IN/OUT LOG buffer dialog box, use the `IICDO` command.

Figure 11.24 IIC IN/OUT LOG Buffer Display

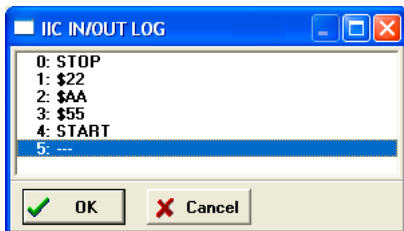

At any point, the `IICCLR` command can flush the input as well as input/output log MMIIC buffers.

After the MMIIC simulated input is received, the first queued in data byte is passed from the data buffer into the corresponding MMIIC module registers. It can be observed in the Memory Window by displaying the appropriate register location there.

Figure 11.25 Memory Component Window

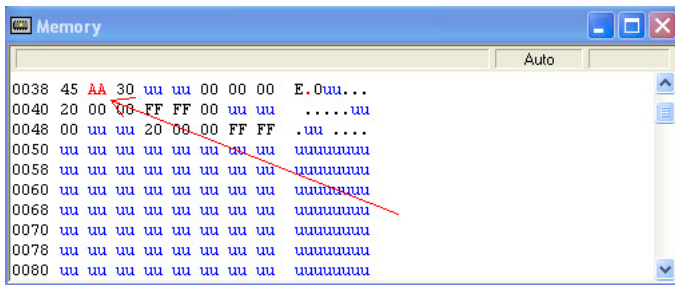

The user can also observe different MMIIC flags in the Memory Window. If the module is run in Flag Polling mode, poll the flag corresponding to the expected MMIIC event. If the MMIIC interrupts are enabled, the FCS jumps to an appropriate subroutine as long as the MMIIC interrupt vectors are properly defined.

For more information on how to configure the MMIIC module for desired operation, refer to the Freescale user manual corresponding to your microprocessor.

Multi-Master Inter-Integrated Circuit Module Commands

The following commands are available for multi-master inter-integrated circuit manipulation.

IICDI Command

The IICDI command allows the user to input data into a buffer of data which is shifted into the MMIIC module when it receives data from an external device. If a data parameter is given, the value is placed into the next slot in the input buffer. If no parameter is given, a window appears displaying the input buffer values. You can enter input values while the window is open. The maximum number of input values is 256.

This command is useful for either inputting response data from a slave target or for inputting data packets from an external master. Note that when the microprocessor attempts to read an acknowledge from an external device, and the next value in the buffer is neither ACK nor NACK, the microprocessor automatically receives an ACK signal (i.e. assumes ACK unless NACK is specified).

Syntax:

```
>IICDI [<n>] [START] [STOP] [ACK] [NACK]
```

Where:

<n> The value to be entered into the next location in the input buffer

START indicates the incoming START signal

STOP indicates the incoming STOP signal

ACK corresponds to ACK signal

NACK corresponds to NACK signal

For a detailed description of the IIC protocol and the proper way to configure the IIC module, refer to the Freescale user manual for your microprocessor.

Example:

```
>IICDI
```

Pulls up the data window with all the input values

```
>IICDI 22 33
```

This is an example of data being returned from a slave device. Once the MCU transmits a start signal and the target address, it receives an ACK from the slave device. An ACK is implied unless a NACK is specified via the IICDI command.

The next two data bytes read are 22 and 23. If the microprocessor attempts to read another byte, it gets a \$FF value followed by a NACK signal (NACK because nothing remains in the input buffer). The receiving device then generates a STOP signal. A more exact input from a device designed to return two bytes is:

```
>IICDI ACK 22 ACK 23 NACK
```

MMIIC in master mode transmits to a slave. If the slave device acknowledges all output bytes of the transmitting device, there is no need to specify an input packet. If the master device is going to transmit an address and two bytes, the following packet is equivalent to no packet:

```
>IICDI ACK ACK ACK
```

If, however, the slave receiver is designed to generate a NACK signal after the second received data byte, the proper response packet is:

```
>IICDI ACK ACK NACK
```

The address result being the first ACK, the first data result being the second ACK, and the second data byte being the NACK.

MMIIC in MASTER mode is not acknowledged by any Slave:

```
>IICDI NACK
```

If the NACK signal is entered before our master device transmits a START signal, then the master device receives a NACK signal when it tries to read an acknowledge after the address is output. The master device then generates a STOP signal and releases the BUS.

MMIIC in SLAVE mode receives a Write from an external Master:

This example is for an external master which is writing to the microprocessor configured to simulate the slave mode operation. The packet contains both START and STOP signals which put the simulated device into the slave mode.

```
>IICDI START 55 AA 22 STOP
```

This input adds five values to the input queue, which is a packet from an external master, including the following values:

- A start signal comes in.
- The address \$55 comes in specifying a write (slave receive). The Address Register of the current simulated device was previously set to \$55.
- The data byte \$AA comes in.
- The data byte \$22 comes in.
- A STOP signal comes in.

HC08 Full Chip Simulation

Configuration Procedure

IICDO

The IICDO command displays a window, which shows data shifted in as well as shifted out of the IIC peripheral. An arrow is used to point to the last output value transmitted/received. The maximum number of output values that the buffer can hold is 256.

Syntax

```
>IICDO
```

Example

```
IICDO
```

View data from the input/output log buffer for IIC simulation.

IICCLR

Use the IICCLR command to flush the input and output buffers for MMIIC simulation. This resets the buffers and clears all values. Notice that if the MMIIC is currently shifting a value, this command allows the MMIIC to finish the transfer.

Syntax

```
>IICCLR
```

Example

```
>IICCLR
```

Clear input and output buffers for IIC simulation.

FCSMSCAN Controller Module

The MSCAN Controller Module fully simulates the operation of the MSCAN08 Protocol Version 2.0 based device, including:

- Flag polling
- Interrupt enabled mode
- 0-8 bytes data length
- Transmission and reception of external data

FCMSCAN08 Background and Assembly Example

The MSCAN08 peripheral is a scalable control area network (CAN) 2.0 compliant device that allows microcontrollers to exchange data between themselves at high speeds. This is done through a high-speed serial link that is deterministic and reliable. CAN devices are often utilized in automobiles, where multiple microcontrollers need to be connected into a network. The CAN specification indicates that any unit on the bus can be a master at any time, where they can send a message to another unit whenever they wish if the bus is free to do so. All of these messages can be setup through the CAN I/O commands built into the simulator. This section goes through an example of this, showing how the simulator can be used to test out code for driving the CAN peripheral

[Listing 11.1](#) is an example assembly program that exercises the CAN 2.0 peripheral on the 68HC908AZ60. The source assembly file can be download from P&E Microcomputer website at www.pemicro.com. With minor modifications this assembly file can be added and compiled as a part of your Freescale project. It initializes the CAN peripheral on the microcontroller for operation and uses interrupts from the CAN peripheral to service requests from other controllers. Once the code is compiled and loaded into the microprocessor that you are using, simulator commands can be used to emulate the CAN messages that come from the host. Let us first break down what is being done in the example program.

FCSDemo CAN Program

This code simply sets up the CAN controller to be ready to receive CAN messages intended for hexadecimal address 0x01234567. Note that this peripheral allows the user to setup filters for address matching, where only certain bit fields of the address need to match in order to receive the data. In our case we just setup the filters for 32-bit exact match. An interrupt service routine is created for the CAN peripheral and is used to collect messages that are received.

The code also tries to send out three fixed messages in memory out to the network. Each of these messages has three different locations that they are sent to. The priorities for the messages are also setup to be different, to show how prioritization works with the CAN peripheral.

Listing 11.1 68HC908AZ60 MSCAN Demonstration Application

```
; 68HC908AZ60 MSCAN Demonstration Application
; (C)opyright P&E Microcomputer Systems, 2000

$pagewidth 120t

RAMStart      equ      $0050                ; start of RAM for AZ60
```



HC08 Full Chip Simulation

Configuration Procedure

```
RomStart      equ    $8000                ; start of Flash1 for AZ60
VectorStart   equ    $FFCC                ; start of Vectors for AZ60

$Include 'az60regs.inc'

CANAddress    equ    $01234567           ; fixed address of this CAN Module

    org RamStart
buffptr       ds      2                  ; pointer into the local data buffer
dataptr       ds      2                  ; pointer into the CAN receiver data buffer
datacount     ds      1                  ; holds the number of bytes in messages
PacketData    ds      $100              ; buffer for data from received packets
PacketDataEnd:

    org RomStart
* Transmission Message Descriptors
* All messages are extended data types
* Format is Address, Priority, Length, Data
Msg1_Desc:
    dw $0001                ; Message 1 Address
    dw $2345                ; Message 1 Address
    db $03                  ; Message 1 Priority
    db $08                  ; Message 1 Length
    db $11                  ; Data Byte 1
    db $22                  ; Data Byte 2
    db $33                  ; Data Byte 3
    db $44                  ; Data Byte 4
    db $55                  ; Data Byte 5
    db $66                  ; Data Byte 6
    db $77                  ; Data Byte 7
    db $88                  ; Data Byte 8
M1Desc_End:

Msg2_Desc:
    dw $0002                ; Message 2 Address
    dw $3456                ; Message 2 Address
    db $02                  ; Message 2 Priority
    db $04                  ; Message 2 Length
    db $12                  ; Data Byte 1
    db $34                  ; Data Byte 2
    db $56                  ; Data Byte 3
    db $78                  ; Data Byte 4
M2Desc_End:

Msg3_Desc:
    dw $0003                ; Message 3 Address
    dw $4567                ; Message 3 Address
    db $01                  ; Message 3 Priority
```

```

        db $02                ; Message 3 Length
        db $55                ; Data Byte 1
        db $AA                ; Data Byte 2
M3Desc_End:

*****
* Init_CAN - The CAN is placed into the soft reset state, *
* where the control and timing registers can be *
* set and the identifier and mask registers can be *
* configured. After this, the module is placed in *
* normal mode in order to synchronize with the CAN *
* bus. *
*****
Init_CAN:
    lda    #$01
    sta    CMCR0                ; place MSCAN08 into soft reset state
    lda    #$01
    sta    CMCR1                ; CAN clock source = CGMOUT*2
    lda    #$01
    sta    CBTR0                ; set SJW=0, baud rate prescalar=div by 2
    lda    #$27
    sta    CBTR1                ; set TSEG1=7 (8Tq), TSEG2=2 (3Tq), one
                                ; sample per bit
    lda    #{(CANAddress>21t) & $FF} ; set identifier acceptance
                                ; register to CAN address
    sta    CIDAR0
    lda    #{(CANAddress & $38000)>15t}
    ora    #{(CANAddress & $1C0000)>13t}
    ora    #$18
    sta    CIDAR1
    lda    #{(CANAddress & $7F80)>7t}
    sta    CIDAR2
    lda    #{(CANAddress & $7F)<1t}
    sta    CIDAR3
    lda    #$00
    sta    CIDMR0                ; set identifier mask register to exact match
    sta    CIDMR1
    sta    CIDMR2
    sta    CIDMR3
    lda    #00
    sta    CIDAC                ; set identifier acceptance for single
                                ; 32-bit filter
    ldhx   #Msg1_Desc            ; set up transmission message 1
    lda    0,x                  ; get message address
    lsla
    lsla
    lsla
    sta    CT0IDR0

```

HC08 Full Chip Simulation

Configuration Procedure

```

lda 1,x                ; get next byte in message address
and  #$E0
lsra
lsra
lsra
lsra
lsra
ora  CT0IDR0
sta  CT0IDR0
lda 1,x                ; get next byte in message address
and  #$1C
lsla
lsla
lsla
ora  #$18
sta  CT0IDR1
lda 1,x                ; get next byte in message address
and  #$03
lsla
ora  CT0IDR1
sta  CT0IDR1
lda 2,x                ; get next byte in message address
and  #$80
rola
rola
ora  CT0IDR1
sta  CT0IDR1
lda 2,x                ; get next byte in message address
and  #$7F
lsla
sta  CT0IDR2
lda 3,x                ; get next byte in message address
and  #$80
rola
rola
ora  CT0IDR2
sta  CT0IDR2
lda 3,x                ; get next byte in message address
and  #$7F
lsla
sta  CT0IDR3
lda 4,x                ; get the message priority
sta  CT0TBPR
lda 5,x                ; get the message length
sta  CT0DLR
sta  datacount
lda 6,x                ; get the message data
sta  CT0DSR0

```



```

lda    7,x                ; get the message data
sta    CT0DSR1
lda    8,x                ; get the message data
sta    CT0DSR2
lda    9,x                ; get the message data
sta    CT0DSR3
lda    0a,x               ; get the message data
sta    CT0DSR4
lda    0b,x               ; get the message data
sta    CT0DSR5
lda    0c,x               ; get the message data
sta    CT0DSR6
lda    0d,x               ; get the message data
sta    CT0DSR7
ldhx   #Msg2_Desc        ; set up transmission message 2
lda    0,x                ; get message address
lsla
lsla
lsla
sta    CT1IDR0
lda    1,x                ; get next byte in message address
and    #$E0
lsra
lsra
lsra
lsra
lsra
ora    CT1IDR0
sta    CT1IDR0
lda    1,x                ; get next byte in message address
and    #$1C
lsla
lsla
lsla
ora    #$18
sta    CT1IDR1
lda    1,x                ; get next byte in message address
and    #$03
lsla
ora    CT1IDR1
sta    CT1IDR1
lda    2,x                ; get next byte in message address
and    #$80
rola
rola
ora    CT1IDR1
sta    CT1IDR1
lda    2,x                ; get next byte in message address

```

HC08 Full Chip Simulation

Configuration Procedure

```

and    #$7F
lsla
sta    CT1IDR2
lda    3,x                ; get next byte in message address
and    #$80
rola
rola
ora    CT1IDR2
sta    CT1IDR2
lda    3,x                ; get next byte in message address
and    #$7F
lsla
sta    CT1IDR3
lda    4,x                ; get the message priority
sta    CT1TBPR
lda    5,x                ; get the message length
sta    CT1DLR
sta    datacount
lda    6,x                ; get the message data
sta    CT1DSR0
lda    7,x                ; get the message data
sta    CT1DSR1
lda    8,x                ; get the message data
sta    CT1DSR2
lda    9,x                ; get the message data
sta    CT1DSR3
ldhx   #Msg3_Desc        ; set up transmission message 3
lda    0,x                ; get message address
lsla
lsla
lsla
sta    CT2IDR0
lda    1,x                ; get next byte in message address
and    #$E0
lsra
lsra
lsra
lsra
lsra
ora    CT2IDR0
sta    CT2IDR0
lda    1,x                ; get next byte in message address
and    #$1C
lsla
lsla
lsla
ora    #$18
sta    CT2IDR1

```

```

        lda    1,x                ; get next byte in message address
        and    #$03
        lsla
        ora    CT2IDR1
        sta    CT2IDR1
        lda    2,x                ; get next byte in message address
        and    #$80
        rola
        rola
        ora    CT2IDR1
        sta    CT2IDR1
        lda    2,x                ; get next byte in message address
        and    #$7F
        lsla
        sta    CT2IDR2
        lda    3,x                ; get next byte in message address
        and    #$80
        rola
        rola
        ora    CT2IDR2
        sta    CT2IDR2
        lda    3,x                ; get next byte in message address
        and    #$7F
        lsla
        sta    CT2IDR3
        lda    4,x                ; get the message priority
        sta    CT2TBPR
        lda    5,x                ; get the message length
        sta    CT2DLR
        sta    datacount
        lda    6,x                ; get the message data
        sta    CT2DSR0
        lda    7,x                ; get the message data
        sta    CT2DSR1
SYNCHCAN:
        lda    #$00
        sta    CMCR0                ; allow MSCAN08 to synchronize to the bus
        lda    #$FF
        sta    CRFLG                ; Reset all CAN receiver flags
        lda    #01
        sta    CRIER                ; enable receiver full interrupt
        lda    #$07
        sta    CTFLG                ; Reset all CAN transmitter flags
        rts

```

```

*****
* MAIN_INIT - This is the point where code starts executing *

```

HC08 Full Chip Simulation

Configuration Procedure

```

*                after a RESET.                *
*****
MAIN_INIT:
    rsp
    ldhx #PacketData        ; initialize buffer pointer to start of
                            ; buffer
    sthx buffptr
    lda  #01
    sta  CONFIG1            ; disable COP watchdog
    lda  #01
    sta  CONFIG2            ; MSCAND=0 (enable MSCAN module)
    jsr  Init_CAN           ; Initialize CAN peripheral
    cli  ; Allow interrupts to happen

main_loop:
    nop                    ; do nothing in main loop
    bra  main_loop

*****
* CAN_ISR - CAN Interrupt Service Routine.      *
*        Interrupts here if CAN packet is received that *
*        has the address of this CAN module.    *
*****
CAN_ISR:
    lda  CRDLR              ; get length of data in message
    cbeqa #0,DATADONE      ; if no data in message then done
    sta  datacount
    ldhx #CRDSR0           ; initialize data pointer to first data
                            ; segment
    sthx dataptr
STOREDATA:
    ldhx dataptr           ; get data pointer to data in received
                            ; message
    lda  0,x                ; load data from data segment
    aix  #1                 ; index pointer to next segment
    sthx dataptr          ; save data pointer
    ldhx buffptr           ; get pointer to local circular buffer
    sta  0,x                ; store data in next location
    aix  #1                 ; index pointer to next location
    cphx #PacketDataEnd    ; if end of circular buffer
    bne  CHECKDATAEND      ; then reset pointer to start of
                            ; circular buffer
    ldhx #PacketData
CHECKDATAEND:
    sthx buffptr
    dbnz datacount,STOREDATA ;if no more data in message then done
DATADONE:
    lda  #01

```

```

        sta  CRFLG                ; reset receive flag
        rti

*****
* DUMMY_ISR - Dummy Interrupt Service Routine.          *
* Just does a return from interrupt.                   *
*****
DUMMY_ISR:
        rti                ; simple return

*****
* Vectors - Specifying Reset and MSCAN Interrupt Routines *
*****
        org  VectorStart

        dw  dummy_isr      ; TIMA Channel 5 Vector
        dw  dummy_isr      ; TIMA Channel 4 Vector
        dw  dummy_isr      ; ADC Vector
        dw  dummy_isr      ; Keyboard Vector
        dw  dummy_isr      ; SCI Transmit Vector
        dw  dummy_isr      ; SCI Receive Vector
        dw  dummy_isr      ; SCI Error Vector
        dw  dummy_isr      ; CAN Transmit Vector
        dw  CAN_ISR        ; CAN Receive Vector
        dw  dummy_isr      ; CAN Error Vector
        dw  dummy_isr      ; CAN Wakeup Vector
        dw  dummy_isr      ; SPI Transmit Vector
        dw  dummy_isr      ; SPI Receive Vector
        dw  dummy_isr      ; TIMB Overflow Vector
        dw  dummy_isr      ; TIMB Channel 1 Vector
        dw  dummy_isr      ; TIMB Channel 0 Vector
        dw  dummy_isr      ; TIMA Overflow Vector
        dw  dummy_isr      ; TIMA Channel 3 Vector
        dw  dummy_isr      ; TIMA Channel 2 Vector
        dw  dummy_isr      ; TIMA Channel 1 Vector
        dw  dummy_isr      ; TIMA Channel 0 Vector
        dw  dummy_isr      ; TIM Vector
        dw  dummy_isr      ; PLL Vector
        dw  dummy_isr      ; ~IRQ1
        dw  dummy_isr      ; SWI Vector
        dw  main_init      ; Reset Vector
;
; You may use this code freely as long as this copyright notice
; and website address is included. Visit us at www.pemicro.com

```

So how is the code laid out in order to handle this? The beginning of the code shows symbol defines for addresses within memory for RAM, Flash, and interrupt vectors. The CAN address is specified here as well. Also included are the register file definitions,

HC08 Full Chip Simulation

Configuration Procedure

which give the addresses of peripheral registers on the microcontroller. Following this comes the variable declarations for pointers, counters, and buffers for the received data.

In the Flash ROM, the message descriptions are given, which indicate the destination address, message priority, message length, and the actual data. Note that the number of data bytes can be variable sizes from 0-8. The information needed in these descriptions can be found in the CAN specification and the 68HC908AZ60A datasheet.

After the message descriptions come the actual code, where there are some procedures for handling different tasks. The first is the initialization procedure, which sets up the registers in the CAN peripheral for the intended operation. The CAN peripheral is also enabled at the end of the routine. After this comes the start of the application in the MAIN_INIT procedure, where we call the initialization routines, initialize the pointers and counters, and wait for an interrupt to occur. There is one interrupt service routines for the CAN peripheral in this code which is triggered when the peripheral receives CAN messages specifically intended for it. Note that this application is totally interrupt driven, where the code is driven by any events that take place through the CAN peripheral.

The end of the code shows the interrupt vectors for the microcontroller, where the CAN interrupts and the RESET vector are included. All other vectors are pointed to a dummy interrupt service routine that simply returns from the interrupt.

Once the above mentioned assembly code is compiled as a part of the Freescale project, one can step through it in the Full Chip Simulation mode. The execution starts automatically at the reset location within the code. We are now ready to start debugging the code.

First, we need to step through the beginning of the code in the simulator in order to allow the code to initialize the microcontroller and the CAN peripheral and get ready to start receiving CAN packets from the network. So, the user needs to step through the beginning of the code until they get to the main loop with the `t` command.

At this point we are ready for CAN packets to come into the device. There are three specific commands in the simulator for testing the CAN peripheral: CANIN, CANOUT, and CANCLR (see detailed MSCAN commands description below). The CANIN command allows a user to specify messages coming into the CAN peripheral. The CANOUT command allows a user to see the packets that were sent out from the CAN peripheral. The CANCLR command allows the user to clear all input and output buffers of CAN packets.

Now we can use the CANIN command to specify CAN packets that come from the network to our device. When a user types this command in the simulator, the CAN IN window appears as shown in [Figure 11.26](#). There are no CAN packets specified yet in the window, so we will enter some into it.

Figure 11.26 CAN IN Display



Input packets can be added by double-clicking in the window where the packet is to go or by selecting the row for the packet and clicking the OK button. At this point a new window comes up as shown in [Figure 11.27](#). It is in this window that the user can specify the parameters of the message. The Packet Type list menu allows the user to select the type of CAN packet, that is, a DATA, REMOTE, ERROR, or OVERLOAD packet. The CAN address for the input can be entered in the CAN Address edit box. The address format can be set to be standard (11 bits) or extended (29 bits). Note that if you select an ERROR or OVERLOAD packet, then the DATA field and CAN Address fields are unused and are grayed out. For DATA and REMOTE packets, the DATA field must be filled with the appropriate data. Let's demonstrate how to fill these fields for a data packet coming in to the device from the network.

Figure 11.27 CAN Packet Dialog Box

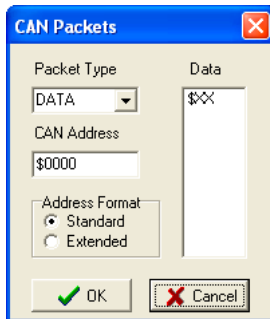

As an example, let us assume that another node in the network wanted to send a packet containing 8 bytes (0,1,2,3,4,5,6,7) to our device at address \$01234567. In this case we want to set the packet type to DATA, the CAN address to \$01234567, the address format to Extended, and the data field for the given 8 bytes. This is shown in [Figure 11.28](#) through the CANIN command.

HC08 Full Chip Simulation Configuration Procedure

Figure 11.28 CAN Example Input Packet

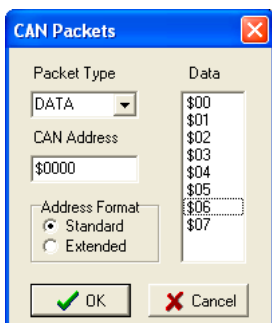

Once the DATA packet information is entered, the CANIN window looks as shown in [Figure 11.29](#). The user can then set a breakpoint in the interrupt service routine that handles CAN packets and execute the code by typing **GO** in the simulator. The user is now at the CAN ISR. By entering the `t` command and single stepping through the code, the user exits the ISR and return to the main loop. The user can then see the resulting data in the memory window pointed to by the `bufferptr` variable, which is the 0, 1, 2, 3, 4, 5, 6, 7 placed in the data packet. [Figure 11.30](#) shows the memory window.

Figure 11.29 CAN IN Display After Data Packet

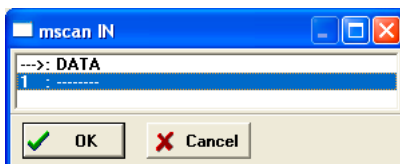
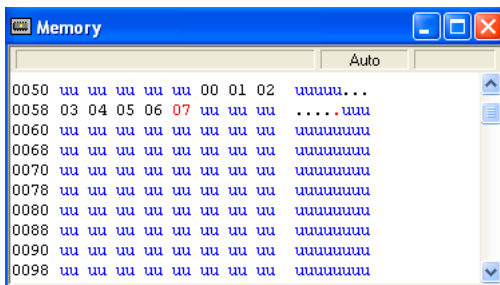

Figure 11.30 Memory Window Showing Received Data



Now, for the output packets that were setup in the initialization routine, we can see that the code sends them out from the simulator by using the CANOUT command. The user can type the command **GO** in the simulator and let the simulation run for a while. Hit the Enter

key to break the execution. Now type the CANOUT command. [Figure 11.31](#) shows the result, where all three output packets are seen. Select the first packet by double clicking on it. [Figure 11.32](#) shows the first CAN packet sent out. Note that the first packet sent out was the packet with the highest priority. You can now select the other packets in the CAN OUT window to open them up and see which data packet they were in.

Figure 11.31 CAN OUT Display

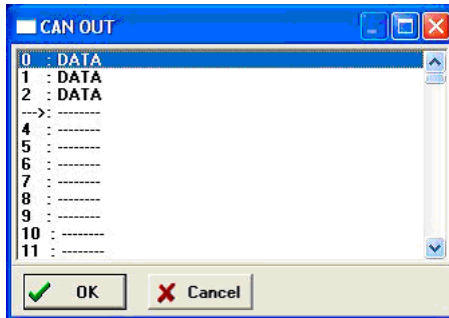
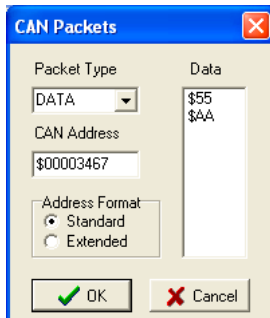

Figure 11.32 CAN Example Output Packet



It is possible that a user does not want to enter all of these simulator commands manually. In this case, use macro files for automated code testing. A macro file permits a user to set up a sequence of simulator commands to run one after the other within the simulator. So, the CANIN command can include parameters that specify the type of packet, CAN address, and data. See the CANIN command in the help file for more details.

FCSMSCAN Commands

You can use the following FCSMSCAN commands with the HC08 processor.

CANCLR Command

You can use the CANCLR command to flush the input and output buffers for CAN simulation. This resets the buffers and clears out all values. Notice that if the CAN is currently shifting a value, this command does not prevent the CAN from finishing the transfer. See CANIN command and CANOUT command for accessing the input and output buffers of the CAN interface.

Syntax

```
>CANCLR
```

Example

```
>CANCLR
```

Clear input and output buffers for CAN simulation

CANIN Command

The CANIN command allows the user to input data into the CAN. If a data parameter is given, the value is placed into the next slot in the input buffer. Otherwise, if no parameter is given, a window is displayed with the input buffer values. Input values can be entered while the window is open.

Figure 11.33 MSCAN_IN Buffer

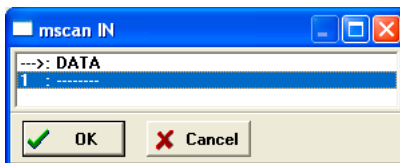

An arrow points to the next input value to the CAN. The maximum number of input packets is 256.

Syntax

```
>CANIN [<n>]
```

Where <n> is the value to be entered into the next location in the input buffer.

Example

```
>CANIN $55
```

Set the next input CAN value to \$55

```
>CAN
```

Pull up the data window with all the input packets.

CANOUT Command

The CANOUT command displays the output of the buffer from the CANOUT. A window is opened that shows all the data that the CAN has shifted out. An arrow is used to point to the last output value transmitted. The maximum number of output packets that the buffer holds is 256 bytes.

Syntax

```
CANOUT
```

Example

```
>CANOUT
```

View data from the output buffer for CAN simulation

FCS Programmable Timer Interrupt Module

In FCS Mode, this module simulates all functionality of the Programmable Timer Interrupt (PIT) module, including:

- Programmable PIT clock input
- Free running or modulo up count operation
- Flag polling
- Interrupt enabled mode of operation

Once the PIT Status and Control register properly configures the operation of the module, the PIT Counter starts incrementing. If you enable modulo up count operation, you can observe the PIT overflow flag in the PIT Status and Control register in the Memory Window.

Figure 11.34 Memory Component Window

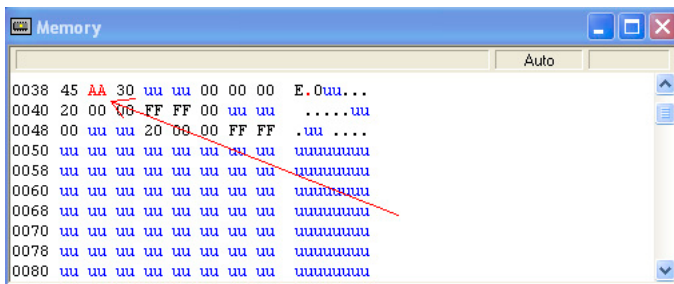

If the PIT interrupt is enabled, the FCS jumps to an appropriate subroutine as long as the PIT interrupt vector is properly defined.

FCS Serial Communications Interface Module

In FCS Mode, this module simulates all functionality of the Serial Peripheral Interface (SPI) module including:

- flag polling
- interrupt enabled mode
- 8- or 9-bit length data codes
- odd and even parity modes
- transmission and reception of external data

FCS mode uses the buffered input/output structure to simulate SCI inputs. The user can queue up to 256 data values into the input buffer. The output buffer of the SCI module can also hold 256 output values. To queue the SCI Input Data, use the `SCDI <n>` command in the command prompt. If `<n>` (the data parameter) is given, the value is placed into the next slot in the input buffer. Otherwise, if no parameter is provided, a window is displayed with the input buffer values. Input values can be entered while the window is open. An arrow points to the next value to be used as input to the SCI. The data from the SCI input buffer is written to the SCI data register once the SCI module has been turned on and is properly configured for receiving data from an external serial device. Once the simulation of the data transmission is over, the arrow moves to the next value in the SCI IN Buffer.

Figure 11.35 SCI IN Buffer Display

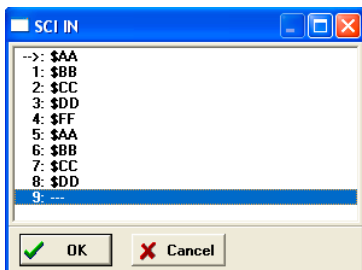

SCI Data Output Buffer simulation allows the user to gain access to the past 256 SCI data values transmitted out of the module. To bring up the SCI OUT buffer dialog box, use the SCDO command.

Figure 11.36 SCI OUT Buffer Display

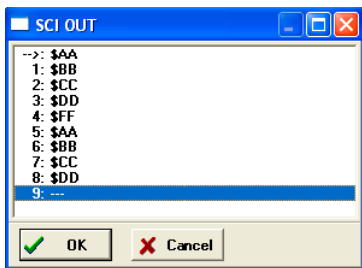

At any point, the SCCLR command can flush the input and output SCI buffers.

After the SCI simulated input is received, the first queued value is passed from the data buffer into the SCI data register. It can be observed in the memory window by displaying the memory location corresponding to the SCI data register.

Figure 11.37 Memory Component Window

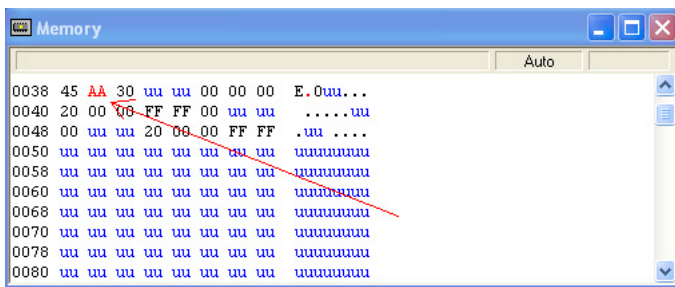

HC08 Full Chip Simulation

Configuration Procedure

The user can also observe different SCI flags in the Memory window. If the module is run in Flag Polling mode, poll the flag corresponding to the expected SCI event. If the SCI interrupts are enabled, the FCS jumps to an appropriate subroutine, as long as the SCI interrupt vectors are properly defined.

For more information on how to configure the SCI module for desired operation, refer to the Freescale user manual for your microprocessor.

FCSSCI Commands

The following FCSSCI commands are available for use with the HC08 processor.

SCCLR Command

Use the SCCLR command to flush the input and output buffers for SCI simulation. This resets the buffers and clears out all values. Notice that if the SCI is in the process of shifting a value, this command allows the SCI to finish the transfer. See SCDI command and SCDO command for accessing the input and output buffers of the SCI interface.

Syntax

```
>SCCLR
```

Example

```
>SCCLR
```

Clear input and output buffer for SCI simulation

SCDI Command

The SCDI command allows the user to input data into the SCI. If a data parameter is given, the value is placed into the next slot in the SCI input buffer. If no parameter is given, a window displays the input buffer values. You can enter input values while the window is open. An arrow points to the next input value to the SCI. The maximum number of input values is 256 bytes.

Syntax

```
>SCDI [<n>]
```

Where:

<n> The value to be entered into the next location in the input buffer

Example

```
>SCDI $55
```

Set the next input value to the SCI to \$55

```
>SCDI
```

Pull up the data window with all the input values.

Figure 11.38 SCI IN Buffer Display

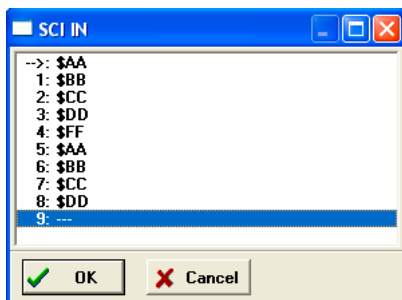

SCDO Command

The SCDO command displays the output buffer from the SCI. A window is opened that shows all the data that the SCI has shifted out. An arrow is used to point to the last output value transmitted. The maximum number of output values that the buffer holds is 256 bytes.

Syntax

```
>SCDO
```

Example

```
>SCDO
```

View data from the output buffer for the SCI simulation.

HC08 Full Chip Simulation

Configuration Procedure

Figure 11.39 SCI OUT Buffer Display

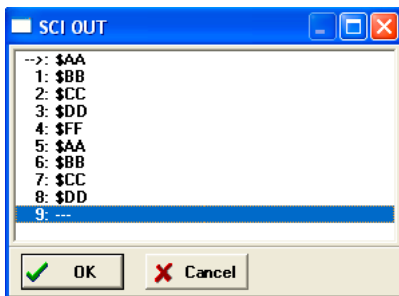

FCS Slave LIN Interface Controller Module

In FCS Mode, this module simulates all functionality of the Slave LIN Interface Controller (SLIC) Module, including:

- Flag polling
- Interrupt enabled mode
- Transmission and reception of external data
- Check sum generation and verification
- Different message lengths data modes

FCS mode uses a buffered structure to simulate SLIC inputs and outputs. The user can queue up to 256 data bytes into the input buffer. The output buffer of the SLIC module can also hold 256 output bytes. To queue the SLIC Input bytes, use the `SLCIN` command in the command prompt. The SLIC command brings up a window, which displays a list of queued in input data. Different SLIC packets can be entered while the window is open. An arrow points to the next byte to be used as input to the SLIC. Once the SLIC module is turned on and properly configured for receiving data from an external SLIC device, the data from the SLIC input buffer is written to the SLIC module identifier or data registers. After the simulation of the data transmission is complete, the arrow moves to the next value in the SLIC IN Buffer.

Figure 11.40 SLIC IN Buffer Display

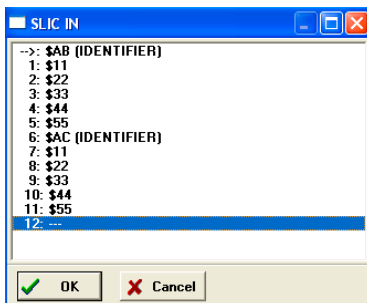
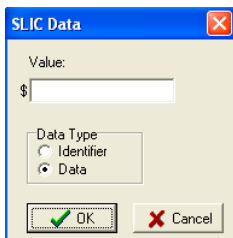
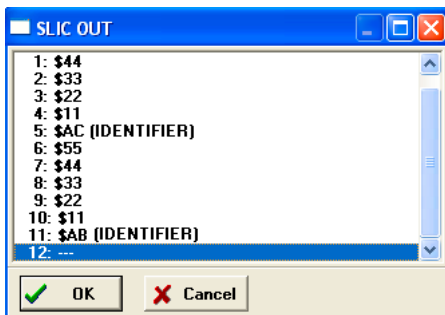

Figure 11.41 SLIC Input Data Configuration Dialog Box



The SLIC data output buffer simulation allows the user to gain access to the past 256 SLIC data bytes transmitted out of the module. To bring up the SLIC OUT buffer dialog box, use the SLCOUT command.

Figure 11.42 SLIC OUT Buffer Display



At any point, use the SLCCLR command to flush the input and output SLIC buffers.

HC08 Full Chip Simulation

Configuration Procedure

After the simulated SLIC input is received, the first queued-in packet is passed from the data buffer into the corresponding SLIC module registers. It can be observed in the Memory Window by displaying the appropriate register location there.

Figure 11.43 Memory Component Window

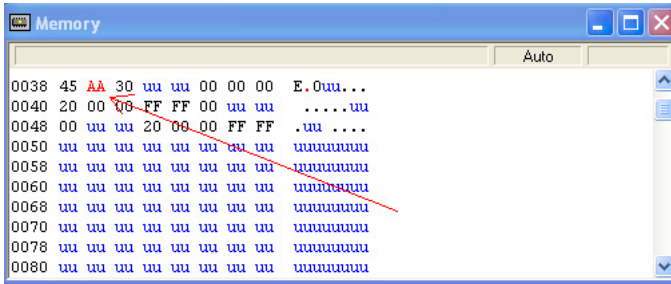

The user can also observe different SLIC flags in the Memory window. If the module is run in Flag Polling mode, poll the flag corresponding to the expected SLIC event. If the SLIC interrupts are enabled, the FCS jumps to an appropriate subroutine, as long as the SLIC interrupt vectors are properly defined. Note that the SLIC State Vector Register reflects the specific SLIC interrupt that was triggered. CPU overhead for servicing different LIN interrupts can be significantly decreased by monitoring the state of this register from within the interrupt subroutine.

For more information on how to configure SLIC module for desired operation, refer to the Freescale manual for your microprocessor.

FCSSLIC Commands

The following FCSSLIC commands are available for use with the M68HC08 processor.

SLCCLR Command

The SLCCLR command can be used to flush the input and output buffers for SLIC simulation. This resets the buffers and clear out all packets. Notice that if the SLIC is currently shifting a value, this command allows the SLIC to finish the transfer. See SLCDI command and SLCDOUT command for accessing the input and output buffers of the SLIC interface.

Syntax

```
>SLCCLR
```

Example

```
>SLCCLR
Clear input and output buffer for SLC simulation
```

SLCDI Command

The SLCDI command is used to simulate SLIC input packets. The first input must be of type “identifier.” Subsequent bytes may either be “data” or “identifier.” After the SLIC Data IN buffer is filled with some data, the SLIC simulation module begins reception of the data packet as soon as it is properly configured and turned on within the user’s firmware. In Byte Transfer Mode, the designation of a byte as either “data” or “identifier” has no effect. The SLIC data input buffer can store up to 256 bytes.

Syntax

```
SLCDI
```

Example

```
SLCDI
Bring up the SLIC IN buffer.
```

Figure 11.44 SLIC Data Input Configuration Dialog Box

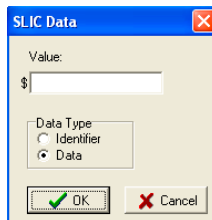
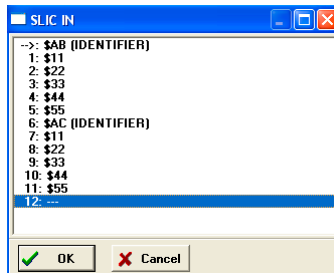

Figure 11.45 SLIC Input Data Buffer



SLCOUT Command

The SLCOUT command displays the output buffer from the SLIC. A window is opened that shows all the data that the SLIC has shifted out, in either Byte Transfer or SLIC Mode. An arrow is used to point to the last output packet transmitted. The maximum number of output packets that the buffer holds is 256 bytes.

Syntax

```
>SLCOUT
```

Example

```
>SLCOUT
```

View packets from the output buffer for SLIC simulation.

FCS Serial Peripheral Interface Module

In FCS Mode, this module simulates all functionality of the Serial Peripheral Interface (SPI) module including:

- Flag polling
- Interrupt enabled mode
- Master and slave modes
- Slave input clock
- Transmission and reception of external data

FCS mode uses the buffered input/output structure to simulate SPI inputs. The user can queue up to 256 data values into the input buffer. The output buffer of the SPI module can also hold 256 output values. To queue the SPI Input Data, use the `SPDI <n>` command at the command prompt. If `<n>` (the data parameter) is given, the value is placed into the next slot in the input buffer. Otherwise, if no parameter is provided, a window is displayed with the input buffer values. You can enter input values while the window is open. An arrow points to the next input value to the SPI. The data from the SPI input buffer is written to the SPI data register once the SPI module has been turned on and is properly configured for receiving data from an external serial device. Once the simulation of the data transmission is over, the arrow moves to the next value in the SPI IN Buffer.

Figure 11.46 SPI IN Buffer Display

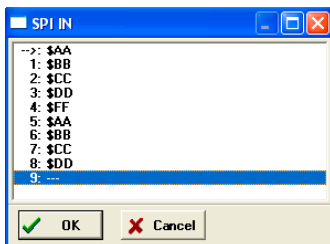

SPI data output buffer simulation allows the user to gain access to the past 256 SPI data values transmitted out of the module. To bring up the SPI OUT buffer dialog box, use the SPDO command.

Figure 11.47 SPI OUT Buffer Display

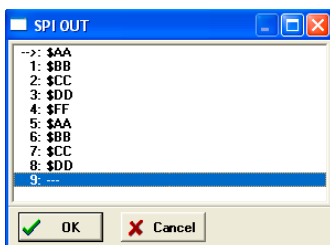

At any point, SPCLR command can flush the input as well as output SPI buffers.

After the SPI simulated input is received, the first queued value is passed from the data buffer into the SPI data register. It can be observed in the Memory Window by displaying the memory location corresponding to the SPI data register.

Figure 11.48 Memory Component Window

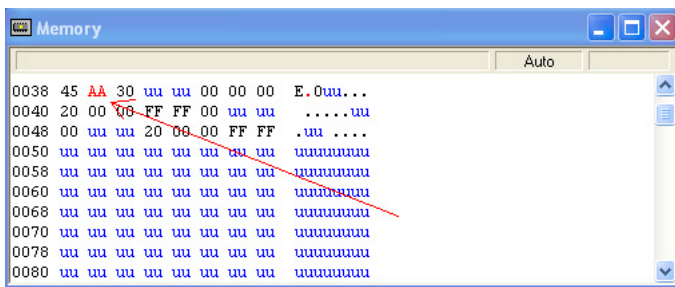

The user can also observe different SPI flags in the Memory window. If the module is run in the Flag Polling mode, poll the flag corresponding to the expected SPI event. If the SPI

HC08 Full Chip Simulation

Configuration Procedure

interrupts are enabled, the FCS jumps to an appropriate subroutine as long as the SPI channel interrupt vectors are properly defined.

To simulate the frequency of the SPI slave input clock, use the `SPFREQ <n>` command. If the SPI is configured for slave mode, this command allows the user to enter the number of cycles `<n>` in the period of the input clock. If the `SPFREQ` command is not used, then clocking is set by the SPI control register.

For more information on how to configure the SPI module for desired operation, refer to the Freescale manual for your microprocessor.

FCSSPI Commands

The following FCSSPI commands are available for use with the M68HC08 processor.

SPCLR Command

Use the `SPCLR` command can be used to flush the input and output buffers for SPI simulation. This resets the buffers and clear out all values. Notice that if the SPI is currently shifting a value, this command allows the SPI to finish the transfer. See `SPDI` command and `SPDO` command for accessing the input and output buffers of the SPI interface.

Syntax

```
>SPCLR
```

Example

```
>SPCLR
```

Clear input and output buffer for SPI simulation

SPDI Command

The `SPDI` command allows the user to input data into the SPI. If a data parameter is given, the value is placed into the next slot in the SPI input buffer. Otherwise, if no parameter is given, a window is displayed with the input buffer values. Input values can be entered while the window is open. An arrow points to the next value to be used as input to the SPI. The maximum number of input values is 256 bytes.

Syntax

```
>SPDI [<n>]
```

Where:

<n> The value to be entered into the next location in the input buffer

Example

```
>SPDI $55
```

Set the next input value to the SPI to \$55

```
>SPDI
```

Pull up the data window with all the input values.

Figure 11.49 SPI IN Buffer Display

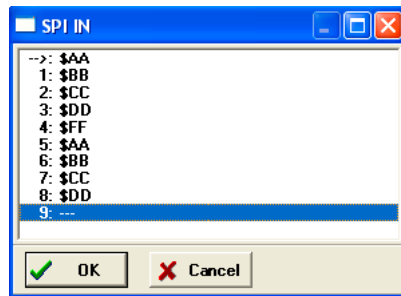

SPDO Command

The SPDO command displays the output buffer from the SPI. A window is opened that shows all the data that the SPI has shifted out. An arrow is used to point to the last output value transmitted. The maximum number of output values that the buffer holds is 256 bytes.

Syntax

```
>SPDO
```

Example

```
>SPDO
```

View data from the output buffer for the SPI simulation.

HC08 Full Chip Simulation

Configuration Procedure

Figure 11.50 SPI OUT Buffer Display

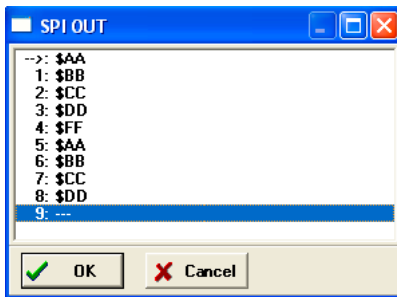

SPFREQ Command

The SPFREQ command lets the user set the frequency of the SPI slave input clock. If the SPI is configured for the slave mode, this command allows the user to enter the number of cycles <n> per one input clock period. If no value is given, a window appears and the user is prompted for a value. If this command is not used, then the clocking is assumed to be set by the SPI control register.

Syntax

```
>SPFREQ [<n>]
```

Where:

<n> The number of cycles for the period of the input clock.

Example

```
>SPFREQ 8
```

Set the period of the input slave clock to 8 cycles (total shift = 8*8 cycles per bit = 64 cycles)

FCSTimer Interface Module

In FCS Mode, this module simulates all functionality of the Timer Interface module, including:

- Input capture/output compare
- Pulse width modulation
- Internal or external clock input
- Free running or modulo up count operation

- Flag polling
- Interrupt enabled mode of operation.

FCS mode uses the simulated port inputs to trigger the input capture on a given timer channel. To define an input state of the specific port, use the `INPUT<x> <n>` command in the Command line window. The `<x>` represents the corresponding I/O port, while `<n>` stands for the input value to write to this port. At the same time, use the `INPUTS` command to display the Simulated Port Inputs for all general I/O ports. It displays the current simulated values for all applicable input ports. See the documentation for the command `INPUT<x>/INPUTS` for more information about the various forms of this command.

Figure 11.51 Simulated Port Inputs Dialog Box

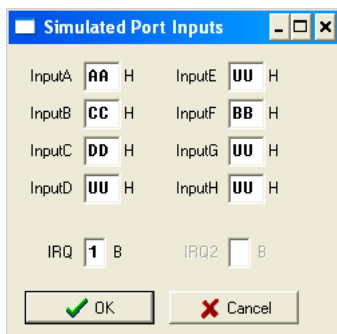

Use the Simulated Port Inputs dialog box to reconfigure the input value to any I/O port. Depending on whether the input capture is set for rising/falling edge, to trigger the event, first set the port inputs to high or low and then invert the inputs to an opposite value. Once the Input Capture event takes place, the CHxF can be observed in the Channel Status and Control register in the Memory window.

Figure 11.52 Memory Component Window

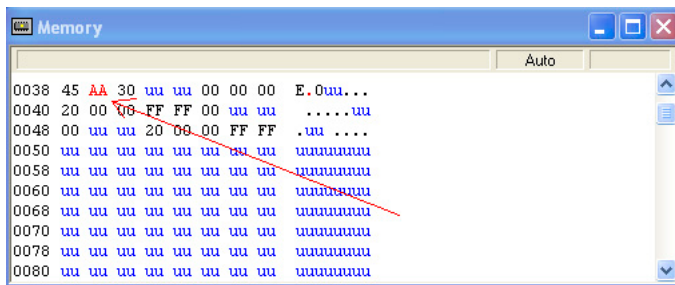

HC08 Full Chip Simulation

Configuration Procedure

If the Timer module is configured for an Output Compare event, once the event takes place the same CHxF Flag can be observed via the Memory window. If the timer channel interrupt is enabled, the FCS jumps to an appropriate subroutine as long as the Timer channel interrupt vector is properly defined. To observe the Timer Overflow Flag (TOF) increasing as a result of the corresponding CPU event, situate your Memory window on the memory location of the Timer Status and Control register.

To observe the Pulse Width Modulation (PWM) operation, properly configure the Timer to operate in the Modulo up count mode, and choose the toggle-on-overflow or clear/set output on compare events to create a desired duty cycle wave. Once a PWM event takes place, pin toggle/clear/set behavior corresponding to the Timer configuration can be observed in the Memory window displaying the IO port associated with a given timer channel.

To observe the accuracy of the Timer module operation, the user can observe the number of CPU cycles that it takes for the event to occur. The cycle counter is only incremented as the user steps through the code. To determine the exact amount of cycles over which the event occurs, one can either observe the cycle display in the Register window or use the built in simulation commands. To display the current number of cycles in the Command window, use the `CYCLES` command. To change the number of cycles in the cycle counter, use `CYCLES <n>`, where `<n>` is the new cycle value. If an event has a pre-calculated number of cycles, use `CYCLE 00` to reset the number of cycles and `GOTOCYCLE <n>` to run through the code until it arrives at the expected event.

Figure 11.53 Register Window With Cycles Display

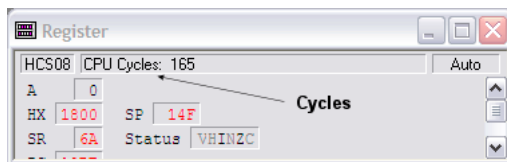

FCS Timer Interface Module Commands

The following FCS timer interface module commands are available for use with the HC08 processor.

CYCLES Command

The CYCLES command changes the value of the cycles counter. The cycles counter counts the number of the processor cycles that have passed during execution. The Cycles Window shows the cycle counter. The cycle count can be useful for timing procedures.

Syntax

```
>CYCLES <n>
```

Where:

<n> Integer value for the cycles counter

Examples

```
>CYCLES 0
```

Reset cycles counter

```
>CYCLES 1000
```

Set cycle counter to 1000.

GOTOCYCLE Command

The GOTOCYCLE command executes the program in the simulator beginning at the address in the program counter (PC). Execution continues until the cycle counter is equal to or greater than the specified value, until a key or the Stop button on the toolbar is pressed, until it reaches a break point, or until an error occurs.

Syntax

```
GOTOCYCLE <n>
```

Where:

<n> Cycle-counter value at which the execution stops

Example

```
>GOTOCYCLE 100
```

Execute the program until the cycle counter equals 100.

INPUT<x> Command

The INPUT<x> command sets the simulated inputs to port <x>. The CPU reads this input value when port <x> is set as an input port.

Syntax

```
INPUT<x> <n>
```

Where:

<x> is the letter representing corresponding port

<n> Eight-bit simulated value for port <x>

Example

```
>INPUTA AA
```

Simulate the input AA on port A.

INPUTS Command

In Full Chip Simulation and CPU-Only Simulation mode, the INPUTS command opens the Simulated Port Inputs dialog box shown in [Figure 11.54](#). Use this box to specify the input states of port pins and IRQ.

Figure 11.54 Simulated Port Inputs Dialog Box

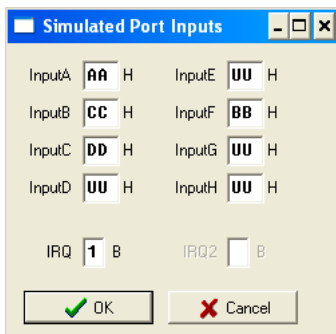

When using In-Circuit Simulation mode, the INPUTS command shows the simulated input values to any applicable port.

Syntax

```
>INPUTS
```

Example

```
>INPUTS
```

Show I/O port input values.

FCS Universal Serial Bus (USB) Module

Some of the microcontrollers in the MC68HC08 family contain USB compliant peripheral devices. These can be low-speed or high-speed USB slave devices. This means that all USB transfers are initiated by a host (i.e. a personal computer) and that the microcontroller needs to be setup to respond with the appropriate acknowledgement messages. According to the USB specification, there are a series of messages that go back and forth between the host and the device in order to setup and describe the channel for data transfer. All of these messages can be set up through the USB I/O commands built into the full chip simulator.

This FCS mode simulates all functionality of the Universal Serial Bus (USB) module including:

- Flag polling
- Interrupt enabled mode
- Transmission and reception of external data
- Endpoint 0/1/2 modes of operation
- USB reset functionality
- STALL, NAK and ACK handshakes

This section goes through an example of assembly code, showing how the simulator can be used to test out code for driving the USB peripheral.

[Listing 11.2](#) shows an assembly program that exercises the USB full speed peripheral on the 68HC908JW32. The source assembly file can be downloaded from the P&E Microcomputer website at www.pemicro.com. With minor modifications this assembly file can be added and compiled as a part of your Freescale project. It sets the microcontroller up as a simple USB human interface device (HID) and uses interrupts from the USB peripheral to service requests from the host. This code can be assembled and then loaded into the ICS08 simulator for execution, after which simulator commands can be used to emulate the USB packets that come from the host. Let us first break down what is being done in the example program.

Listing 11.2 68HC908JW32 USB HID Demonstration Application

```
; 68HC908JW32 USB HID Demonstration Application
```



HC08 Full Chip Simulation

Configuration Procedure

```
; (C)opyright P&E Microcomputer Systems, 2005
;
; You may use this code freely as long as this copyright notice
; and website address is included. Visit us at www.pemicro.com

; This application is meant to demonstrate a framework for an
; application running on the 68HC908JW32. It demonstrates a simple HID
; interface for a USB device and uses interrupts from the USB
; peripheral. The HID interface is supported through standard API calls
; in Windows® XP, Windows® 2000, or Windows Vista™ Operating Systems.
; For more information on USB, visit the USB
; developers website at www.usb.org and download the USB specification
; revision 2.0 and the HID device class specification version 1.1 for
; more details.

RAMStart      equ    $0060                ; start of RAM for JW32
RomStart      equ    $7000                ; start of Flash for JW32
VectorStart   equ    $FFEE                ; start of Vectors for JW32
EP1BuffStart  equ    $1000                ; start of buffer for endpoint
1 of the USB
EP2BuffStart  equ    $1010                ; start of buffer for endpoint
2 of the USB

$Include 'JW32regs.inc'

    org RamStart
Setup_Packet   ds      8                  ; array for SETUP packet
bmReqType     equ    Setup_packet        ; Characteristic of Request
bRequest      equ    {Setup_packet+1}    ; Request Code
wValueL       equ    {Setup_packet+2}    ; Low byte Value Field
wValueH       equ    {Setup_packet+3}    ; High byte Value Field
wIndexL       equ    {Setup_packet+4}    ; Low byte Index Field
wIndexH       equ    {Setup_packet+5}    ; High byte Index Field
wLengthL      equ    {Setup_packet+6}    ; Low byte Length Field
wLengthH      equ    {Setup_packet+7}    ; High byte Length Field

GET_DESC      equ    6                    ; Standard Request code for
GET_DESCRIPTOR
SYNC_FRAME    equ    12t                 ; Standard Request code for SYNC_FRAME

control       ds      1                  ; type of transfer in progress
descptr       ds      2                  ; pointer to descriptor being sent
descndptr     ds      2                  ; end pointer to descriptor being sent
buffptr       ds      2                  ; index into the USB data buffer
tptr          ds      2                  ; temporary pointer for storage
EP2data       ds      8                  ; endpoint 2 output received data

    org RomStart
```

* The following descriptors give the information to the PC what type of
 * USB device this is and what its capabilities are. They are retrieved
 * during the configuration phase.

* Note that the Vendor and Product IDs specified in this demo are
 * invalid USB IDs and are given for demonstration purposes only!
 *

* Device Descriptor

```
Dev_Desc:
    db {DDesc_End-Dev_Desc} ; Descriptor Length
    db $01                  ; Descriptor Type (Device)
    db $00,$02              ; USB specification Release (2.00)
    db $00                  ; Class Code
    db $00                  ; Subclass Code
    db $00                  ; Protocol Code
    db $08                  ; Maximum Packet Size for EP0 (8 bytes)
    db $00,$00              ; Vendor ID=none
    db $00,$00              ; Product ID=none
    db $01,$00              ; Device Release Number (1.00)
    db $01                  ; Index to Manufacturer String Descriptor
    db $02                  ; Index to Product String Descriptor
    db $00                  ; Index to Device Serial Number String
                          ; Descriptor
    db $01                  ; Number of possible configurations (1)
DDesc_End:
```

* Configuration Descriptor

```
Con_Desc:
    db {CDesc_End-Con_Desc} ; Descriptor Length
    db $02                  ; Descriptor Type (Configuration)
    db {E2Desc_End-Con_Desc},$00 ; Total data length (Config-
                          ; Interface-EP)
    db $01                  ; Interfaces supported
    db $01                  ; Configuration Value
    db $00                  ; Index to String Descriptor
    db $C0                  ; Self powered
    db $00                  ; Maximum power consumption=0mA
                          ; (not applicable)
CDesc_End:
```

* Interface Descriptor

```
Int_Desc:
    db {IDesc_End-Int_Desc} ; Descriptor Length
    db $04                  ; Descriptor Type (Interface)
    db $00                  ; Number of Interface
    db $00                  ; No alternate setting
    db $02                  ; Number of endpoints
```

HC08 Full Chip Simulation

Configuration Procedure

```

        db $03                ; Class Code (HID)
        db $00                ; Subclass Code
        db $00                ; Protocol Code
        db $00                ; Index to String Descriptor
IDesc_End:

* HID Descriptor
HID_Desc:
    db {HDesc_End-HID_Desc} ; Descriptor Length
    db $21                  ; Descriptor Type (HID)
    db $00,$01             ; HID Class Release (1.00)
    db $00                  ; Country Code=$00
    db $01                  ; number of HID class descriptors
    db $22                  ; Class Descriptor Type (REPORT)
    db {RDesc_End-Rep_Desc},$00 ; length of report descriptor
HDesc_End:

* Endpoint 1 Descriptor
Endp1_Desc:
    db {E1Desc_End-Endp1_Desc} ; Descriptor Length
    db $05                  ; Descriptor Type (Endpoint)
    db $81                  ; Endpoint Number and Direction (#1,IN)
    db $03                  ; Endpoint Attribute (Interrupt)
    db $01,$00             ; Maximum Packet Size for EP1 (1 byte)
    db $FF                  ; Polling Interval=255[ms]
E1Desc_End:

* Endpoint 2 Descriptor
Endp2_Desc:
    db {E2Desc_End-Endp2_Desc} ; Descriptor Length
    db $05                  ; Descriptor Type (Endpoint)
    db $02                  ; Endpoint Number and Direction (#2,OUT)
    db $02                  ; Endpoint Attribute (Bulk)
    db $08,$00             ; Maximum Packet Size for EP2 (8 bytes)
    db $FF                  ; Polling Interval=255[ms]
E2Desc_End:

* Report Descriptor
Rep_Desc:
    db $06,$00,$FF        ; Usage Page (vendor defined)
    db $09,$01            ; Usage (vendor defined)

    db $A1,$01            ; Collection (Application)
    db $09,$02            ; Usage (vendor defined)

; Input report
    db $09,$03            ; Usage (vendor defined)
    db $15,$00            ; Logical Minimum ($00)

```



```

        db  $26,$FF,$00          ; Logical Maximum ($FF)
        db  $75,$08             ; Report Size (8 bits)
        db  $95,$01             ; Report Count (1 field)
        db  $81,$02             ; Input (Data, Variable, Absolute)

        db  $C0                  ; End Collection
RDesc_End:

*****
* Init_USB - Disables receive and transmit for all endpoints. *
*           The USB state is set to powered, where the part *
*           is waiting for an USB reset and for it to be    *
*           addressed and configured.                        *
*****
Init_USB:
        clr   control           ; waiting for control packets
        mov   #$00,USBSR        ; Reset all USB flags
        mov   #$2d,USIMR        ; Enable interrupts for config change,
                                ; setup, reset, and suspend events
        mov   #$d0,UEP1CSR      ; enable EP1 as interrupt, IN direction,
                                ; buffer size of 8
        mov   #$80,UEP2CSR      ; enable EP2 as bulk, OUT direction,
                                ; buffer size of 8
        mov   #$20,UEP12BPR     ; set base address pointer for EP1 to
                                ; $1000, EP2 to $1010
        mov   #$00,UINTFCR      ; set interface number for EP1,EP2 to 0
        mov   #$4e,USBCR        ; turn on USB clocking, enable
                                ; interrupts for endpoint 0,1,2 transfers
        mov   #$ce,USBCR        ; enable USB module
        rts

*****
* FORCE_STALL - A packet is received in the control stage that *
*             is not supported. So the device stalls until    *
*             new SETUP packet arrives at endpoint 0.         *
*****
FORCE_STALL:
        lda   USIMR             ; request not handled
        ora   #40               ; set EP0_STALL
        sta   USIMR             ; new SETUP packet clears STALL
        rts                     ; bits automatically

*****
* GETDESC_PROC - This procedure handles the standard request  *
*               to get the device's descriptors.              *
*****
GETDESC_PROC:

```

HC08 Full Chip Simulation

Configuration Procedure

```

ldhx #0 ; clear H:X pointer
lda wValueH ; check which descriptor is wanted
cbeqa #$1,GETDEVDESC ; is it device descriptor?
cbeqa #$2,GETCONDESC ; is it configuration descriptor?
cbeqa #$21,GETHIDDESC ; is it for HID descriptor?
cbeqa #$22,GETREPDESC ; is it for Report descriptor?
jmp GETDESC_STALL ; else go stall

GETDEVDESC:
lda Dev_Desc,x ; take device descriptor information
sta UE0D0,x ; store in USB endpoint 0 data buffer
incx
cpx #8 ; all descriptors more than 8 bytes
bne GETDEVDESC
ldhx #DDesc_End ; store end location of the descriptor
sthx descendptr
ldhx #Dev_Desc ; store pointer to next byte in
; descriptor
bra GETDESC_END

GETCONDESC:
lda Con_Desc,x ; take configuration descriptor
; information
sta UE0D0,x ; store in USB endpoint 0 data buffer
incx
cpx #8 ; all descriptors more than 8 bytes
bne GETCONDESC
ldhx #E2Desc_End ; store end location of the descriptor
sthx descendptr
ldhx #Con_Desc ; store pointer to next byte in
; descriptor
bra GETDESC_END

GETHIDDESC:
lda HID_Desc,x ; take HID descriptor information
sta UE0D0,x ; store in USB endpoint 0 data buffer
incx
cpx #8 ; all descriptors more than 8 bytes
bne GETHIDDESC
ldhx #HDesc_End ; store end location of the descriptor
sthx descendptr
ldhx #HID_Desc ; store pointer to next byte in descriptor
bra GETDESC_END

GETREPDESC:
lda REP_Desc,x ; take report descriptor information
sta UE0D0,x ; store in USB endpoint 0 data buffer
incx

```

```

        cpx    #8                ; all descriptors more than 8 bytes
        bne   GETREPDESC
        ldhx  #RDesc_End        ; store end location of the descriptor
        sthx  descndptr
        ldhx  #REP_Desc         ; store pointer to next byte in descriptor

GETDESC_END:
        sthx  descptr
        lda   descptr+1        ; add length specified in setup packet
        add  wLengthL         ; and store in tptr
        sta  tptr+1
        lda  descptr
        adc  wLengthH
        sta  tptr
        ldhx tptr             ; is calculated pointer >= end of descriptor?
        cphx descndptr        ; if so then end_pointer = end of descriptor
        bge  GETDESC_END2     ; else, end_pointer= calculated pointer
        sthx descndptr

GETDESC_END2:
        ldhx  descptr         ; get pointer to start of descriptor
        aix   #8              ; eight bytes sent already
        sthx  descptr         ; store current pointer
        mov   #$88,UEP0CSR    ; SIZE=8 bytes, IN packet data ready
        mov   #GET_DESC,control ; set flag for control transfer type
        bra  GETDESC_EXIT

GETDESC_STALL:
        jsr   FORCE_STALL

GETDESC_EXIT:
        rts

*****
* SETUP_PROC - This procedure handles the SETUP packets that *
*              come into the USB peripheral. The only standard *
*              device requests handled are SYNC_FRAME, *
*              GET_DESCRIPTOR, and vendor-specific requests. *
*****
SETUP_PROC:
        clr   control         ; clear flag for control transfer
        lda  UEP0CSR         ; check size of SETUP packet
        lsra
        lsra
        lsra
        lsra
        cmp  #8              ; is SIZE=8?
        bne  SETUP_EXIT     ; if not then exit

```

HC08 Full Chip Simulation

Configuration Procedure

```

        ldhx  #8
SAVE_SETUP:
        lda   {UE0D0-1},x      ; save data to array
        sta   {Setup_packet-1},x ; Setup_packet holds info
        dbnzx SAVE_SETUP
        lda   bmReqType        ; if request type is standard
        and   #$60             ; then go handle standard request
        bne   SETUP_STALL     ; otherwise, force stall

STANDARD:
        lda   bRequest         ; get request type
        cbeqa #GET_DESC,GET_DESCR ; if getting descriptors then
                                   ; ready the next IN packets for
                                   ; the descriptor information
        bra   SETUP_STALL     ; otherwise, force stall

GET_DESCR:
        jsr   GETDESC_PROC     ; packet received was GET_DESCRIPTOR
        bra   SETUP_EXIT      ; go exit

SETUP_STALL:
        jsr   FORCE_STALL      ; error, force stall on endpoint 0

SETUP_EXIT:
        lda   UEPOCSR         ; setup endpoint 0 for more packets
        and   #$fc
        sta   UEPOCSR
        bclr  5,USBSR         ; clear setup flags
        rts

*****
* IN_PROC - This procedure handles the IN packets that come *
*           into the USB peripheral through endpoint 0.      *
*****
IN_PROC:
        lda   control         ; is this IN packet for data stage
        cmp   #GET_DESC      ; of GET_DESCRIPTOR?
        bne   IN_PROC2
        ldhx  #0             ; clear index into data buffer
        sthx  buffptr

IN_SEND_DATA:
        ldhx  descptr        ; get pointer to descriptor
        lda   0,x           ; get descriptor byte
        aix   #1
        sthx  descptr        ; save pointer to descriptor
        ldhx  buffptr        ; get index to data buffer
        sta   UE0D0,x       ; place byte in buffer
        aix   #1

```

```

        sthx  buffptr          ; save index to data buffer
        ldhx  descptr         ; is it last descriptor byte?
        cphx  descendptr
        beq   LAST_DESC
        ldhx  buffptr         ; is data buffer filled?
        cphx  #8
        beq   DATAFILLED    ; go send data
        bra   IN_SEND_DATA    ; else continue

LAST_DESC:
        clr   control        ; if so then end of data transfer
DATAFILLED:
        lda   buffptr+1      ; set the size of the buffer
        asla                ; shift to upper nibble
        asla
        asla
        ora   #$08           ; set DVALID_IN bit that data is ready
        sta   UEPOCSR
        rts

IN_PROC2:
        bclr  2,UEPOCSR      ; clear the TFRC_IN bit for further
packets
        rts

*****
* OUT_PROC - This procedure handles the OUT packets that are *
*             sent by the USB peripheral through endpoint 0. *
*****
OUT_PROC:
        lda   UEPOCSR        ; setup endpoint 0 for more packets
        and  #$fc           ; all OUT packets received for endpoint 0
        sta   UEPOCSR        ; should be for status stage of requests
        rts

*****
* MAIN_INIT - This is the point where code starts executing *
*             after a RESET. *
*****
MAIN_INIT:
        rsp
        clra
        clrx
        mov  #$01,CONFIG     ; URSTD=1 (USB reset=interrupt),
                             ; disable COP watchdog
        mov  #$FF,PULLCR    ; enable pullups for port B
        jsr  Init_USB       ; Initialize USB peripheral

```

HC08 Full Chip Simulation

Configuration Procedure

```

cli                                ; Allow interrupts to happen

main_loop:
bra    main_loop

*****
* USB_ENDP_ISR - USB Endpoint Interrupt Service Routine.      *
*      Interrupts here if packets are received or            *
*      transmitted on any endpoint.                          *
*****
USB_ENDP_ISR:
brclr 0,UEP0CSR,USB_ENDP_ISR2      ; Is it an OUT packet received?
brclr 1,UEP0CSR,USB_ENDP_ISR2
jsr   OUT_PROC                      ; handle OUT packet for EP0
rti                                     ; exit interrupt

USB_ENDP_ISR2:
brclr 2,UEP0CSR,USB_ENDP_ISR3      ; Is packet sent from IN packet
                                        ; for endpoint 0?
jsr   IN_PROC                       ; handle IN packet for endpoint 0
rti                                     ; exit interrupt

USB_ENDP_ISR3:
brclr 0,UEP1CSR,USB_ENDP_ISR4      ; Is packet sent from IN packet
                                        ; for endpoint 1?
lda   ptb                            ; get Port B value
sta   EP1BuffStart                   ; place in endpoint 1 data buffer
mov   #01,UEP1DSR                   ; set data size for endpoint 1
                                        ; to 1
bclr  0,UEP1CSR                      ; clear the TFRC flag
bset  1,UEP1CSR                      ; set the DVALID flag

USB_ENDP_ISR4:
brclr 0,UEP2CSR,USB_ENDP_EXIT      ; is it a packet for endpoint 2?
brclr 1,UEP2CSR,USB_ENDP_EXIT      ; is it an OUT packet?
ldhx  #0

USB_ISR4_LOOP:
lda   EP2BuffStart,x                ; get data received in endpoint buffer
sta   EP2Data,x                     ; and transfer to local data buffer
aix   #1
cpx   UEP2DSR
bne   USB_ISR4_LOOP
lda   UEP2CSR                       ; clear the TFRC/DVALID flag
and   #$fc
sta   UEP2CSR
rti                                     ; exit interrupt

USB_ENDP_EXIT:

```

```

    rti

*****
* USB_SYS_ISR - USB System Interrupt Service Routine.          *
*     Interrupts here if USB suspend, resume, reset,          *
*     config_chg, start of frame, or setup event              *
*     occurs.                                                  *
*****
USB_SYS_ISR:
    brclr 2,USBSR,USB_SYS_ISR2    ; Is it USB reset?
    bclr  2,USBSR                  ; reset USB reset flag
    rti                            ; exit interrupt

USB_SYS_ISR2:
    brclr 3,USBSR,USB_SYS_ISR3    ; Is there a change in
                                   ; configuration?

    brclr 7,USBSR,USB_CONFIG_CLR
    lda  ptb                       ; get Port B value
    sta  EP1BuffStart              ; place in endpoint 1 data buffer
    mov  #01,UEP1DSR              ; set data size for endpoint 1 to 1
    bclr 0,UEP1CSR                ; clear the TFRC flag
    bset 1,UEP1CSR                ; set the DVALID flag
    bclr 3,USBSR                  ; clear the CONFIG_CHG flag
    rti                            ; exit interrupt

USB_CONFIG_CLR:
    bclr 3,USBSR                  ; clear CONFIG_CHG bit
    rti                            ; exit interrupt

USB_SYS_ISR3:
    brclr 5,USBSR,USB_SYS_ISR4    ; is it SETUP packet?
    jsr  SETUP_PROC                ; handle SETUP packet
    rti                            ; exit interrupt

USB_SYS_ISR4:
    brclr 0,USBSR,USB_SYS_EXIT    ; is it a SUSPEND event?
    bclr 0,USBSR                  ; reset suspend flag
    rti                            ; exit interrupt

USB_SYS_EXIT:
    rti

*****
* DUMMY_ISR - Dummy Interrupt Service Routine.                *
*     Just does a return from interrupt.                      *
*****
DUMMY_ISR:
    rti                            ; simple return

*****

```

HC08 Full Chip Simulation

Configuration Procedure

```

* Vectors - Specifying Reset and USB Interrupt Routines      *
*****
    org    VectorStart

    dw    dummy_isr          ; TIM1 Overflow Vector
    dw    dummy_isr          ; TIM1 Channel 1 Vector
    dw    dummy_isr          ; TIM1 Channel 0 Vector
    dw    dummy_isr          ; PLL Vector
    dw    dummy_isr          ; IRQ Vector
    dw    USB_ENDP_ISR       ; USB Endpoint Vector
    dw    USB_SYS_ISR        ; USB System Vector
    dw    dummy_isr          ; SWI Vector
    dw    main_init          ; Reset Vector

```

This code utilizes three endpoints in the USB peripheral: endpoints 0, 1, and 2. As always, all control transactions occur through endpoint 0. The other endpoints can be set up for data transfer in the input or output direction, depending on whether data needs to be sent or received to/from the host. Here, endpoint 1 is setup as an input pipe and endpoint 2 is setup as an output pipe. The host becomes aware of whether an endpoint is an input or output through the descriptor tables that are exchanged at the beginning of device discovery.

It is necessary for the host and the slave to keep retention of the USB state of the device. There are multiple states for the USB device. The module starts in the POWERED state. When a USB reset is detected, the module is placed into the DEFAULT state. When the device receives a SET_ADDRESS standard device request with a valid address, the device is placed into the ADDRESSED state. Finally, when a SET_CONFIGURATION standard device request is sent, the device is placed into the CONFIGURED state.

After the device is configured, endpoint 1 is enabled for interrupt transfers from the host. Endpoint 1 is only capable of sending information out from it. Therefore, only IN packets are accepted at the endpoint. The report descriptor sets up the endpoint to transfer only 1 byte of data. So when an IN packet comes from the host, the device sends out the data read from the Port B input pins. Note that the internal pull-ups are enabled for PORTB in the code (PULLCR), so the default input value sent through endpoint 1 is \$FF.

After the device is configured, endpoint 2 is enabled for bulk transfers. Endpoint 2 is only capable of reading information into it. Therefore, only OUT packets are accepted at the endpoint. The report descriptor sets up the endpoint to read, at most, 8 bytes of data. So when an OUT packet comes from the PC, the device reads the data from the packet into a local buffer.

So, how is the code laid out in order to handle this? The beginning of the code shows symbol defines for addresses within memory for RAM, Flash, interrupt vectors, and buffers for USB endpoints. Also included are the register file definitions, which give the addresses of peripheral registers on the microcontroller. Following this comes the variable declarations for control packets, pointers, and received data.

In the FLASH, the descriptor tables are created, which describe the type of USB device, the configuration, the interface, HID specific information, the endpoints, and reporting information. All information needed in these descriptors, can be found in the Freescale documentation describing USB module specifications for the microprocessor that you are using.

After the descriptors comes the actual code, where numerous procedures are described, meant to handle different tasks. The first is the initialization procedure, which sets up the registers for the USB peripheral for the intended operation. The USB peripheral is also enabled at the end of the routine. The next several procedures are specifically for USB operation, such as: forcing a device stall, sending the device descriptors to the host, handling SETUP packets, handling IN packets, and processing OUT packets. After this comes the start of the application in the MAIN_INIT procedure, where we call the initialization routines and wait for an interrupt to occur. There are two interrupt service routines for the USB peripheral in this code: one for endpoint events that occur, and the other for USB system events such as setups, stalls, and resets. Note that this application is totally interrupt driven, where the code is driven by any events that take place in the USB peripheral.

The end of the code shows the interrupt vectors for the microcontroller, where the USB interrupts and the RESET vector are included. All other vectors are pointed to a dummy interrupt service routine that simply just returns from the interrupt.

Once the mentioned above assembly code is compiled as a part of the Freescale project, one can step through in the Full Chip Simulation mode. The execution starts automatically at the reset location within the code. We are now ready to start debugging the code.

First, we need to step through the beginning of the code in the simulator in order to allow the code to initialize the microcontroller and the USB peripheral and get ready to start receiving USB packets from the host. So, the user needs to step through the beginning of the code until they get to the main loop with the 't' command.

At this point we are ready for USB packets to come into the device. There are four specific commands in the FCS for simulating external input/output as well as reset and clear functionality of the USB peripheral: USBRESET, USBIN, USBOUT, and USBCLR (for more detailed information, refer to the USB commands section). The USBRESET command causes a USB reset, which is identical to a host trying to reset a slave USB device once it connects to the bus. The USBIN command allows a user to specify packets coming into the USB peripheral. The USBOUT command allows a user to see the packets that were sent out from the USB peripheral. The USBCLR command allows the user to clear all input and output buffers of USB packets. The first command to use for testing the USB peripheral is the USBRESET command, which places the USB peripheral in the RESET state. After the USBRESET command, step through the code with a t command to enter the system interrupt service routine. Enter the t command a few more times to exit the ISR and return to the main loop.

HC08 Full Chip Simulation

Configuration Procedure

Now we can use the USBIN command to specify USB packets that come across the USB bus from the host. When a user types this command in the simulator, the USB IN window appears as shown in [Figure 11.55](#). There are no USB packets specified yet in the window.

Figure 11.55 USB IN Buffer

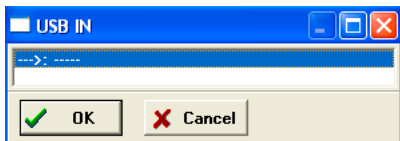

Add input packets by double-clicking in the window where the packet is to go or by selecting the row for the packet and clicking the **OK** button. At this point a new window comes up as shown in [Figure 11.56](#). It is in this window that the user can specify the parameters of the packet. The *Packet Type* list menu allows the user to select the type of USB packet, either a SETUP, IN, OUT, DATA0, DATA1, ACK, NAK, STALL, or SOF packet. Note that if you select a SETUP, IN, or OUT packet, then the DATA field is not utilized. If you select the DATA0 or DATA1 packet, then the **USB Address** and **Endpoint** edit fields are not used. For SETUP, IN, and OUT packets, the **USB Address** and **Endpoint** fields must be filled with the appropriate data.

Here is an explanation of how to fill these fields for a GET DEVICE DESCRIPTOR request from the host, which typically comes after the USB reset.

Figure 11.56 USB Packet Setup Dialog Box

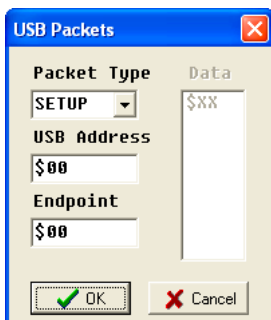

The GET DEVICE DESCRIPTOR request between a host and a slave USB device has three different stages to it, as defined by the USB standard: the setup stage, the data stage, and the status stage. [Figure 11.57](#) shows the flow of packets between the USB host and slave devices for a GET DEVICE DESCRIPTOR request as well as the stages. The setup stage simply consists of a SETUP packet from the host, then a DATA0 packet with the byte codes that indicate that this is a GET DESCRIPTOR, and the acknowledge (ACK) packet from the slave.

To replicate this stage in the simulator, enter the SETUP packet as shown in [Figure 11.56](#) and the DATA0 packet as shown in [Figure 11.58](#), using the USBIN command. The USB peripheral automatically sends out the ACK after the code services the other packets, which are received in the simulator. Once the SETUP and DATA0 packets are entered, the USBIN window looks as shown in [Figure 11.59](#). The user can then step through the setup stage by typing `t` in the simulator. At this point, use the USBOUT command to see that the ACK packet was sent out by the device, as shown in [Figure 11.60](#). This completes the setup stage.

We can utilize the same commands for the data stage, using the USBIN command to create IN and ACK packets. Once the code receives the IN packet, it sends out the descriptor information with data packets through endpoint 0. The ACK packet then is needed to end that data stage transfer. Several data stage transfers are needed to send out all of the device descriptor information. Each data packet can hold only eight bytes, so we need three transfers in this case. [Figure 11.61](#) shows the USB IN window. [Figure 11.62](#) shows the current appearance of the USB OUT window.

HC08 Full Chip Simulation
Configuration Procedure

Figure 11.57 USB Packet Exchange Diagram

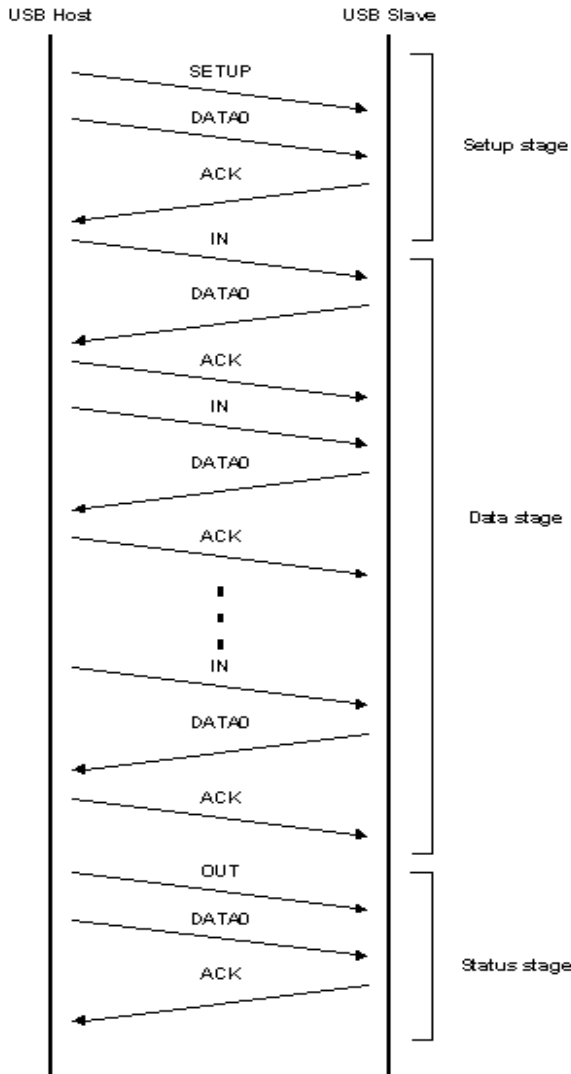

Figure 11.58 USB Packet Setup Full

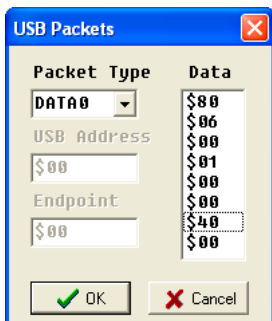

Figure 11.59 USB IN Data Buffer

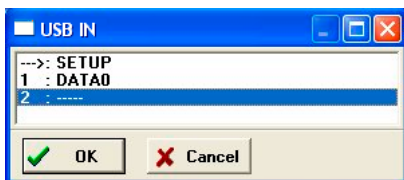

Figure 11.60 USB Out Buffer

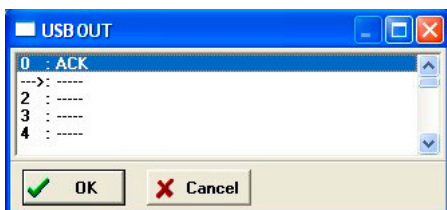
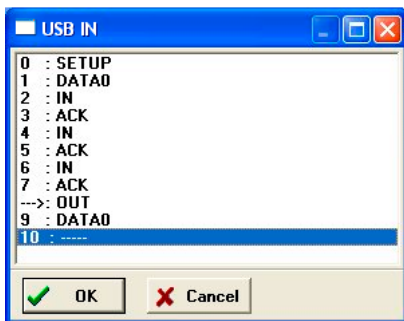

Figure 11.61 USB IN Buffer



HC08 Full Chip Simulation

Configuration Procedure

Figure 11.62 USB OUT Buffer



Notice in [Figure 11.63](#) the DATA0 packet output during the data stage. This packet contains the data found in the device descriptor table in the code. This shows exactly what USB packet information was sent out from the device.

Figure 11.63 USB Packets IN Setup

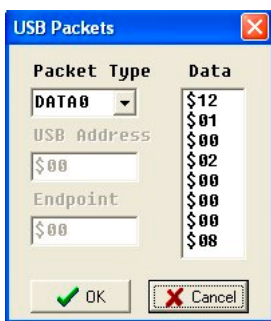

Once we get through the status stage, which requires an OUT packet along with an empty DATA0 packet from the host to be received, we get the USB IN window to look like that shown in [Figure 11.64](#) and the USB out window to look like that shown in [Figure 11.65](#)

Figure 11.64 USB IN Buffer

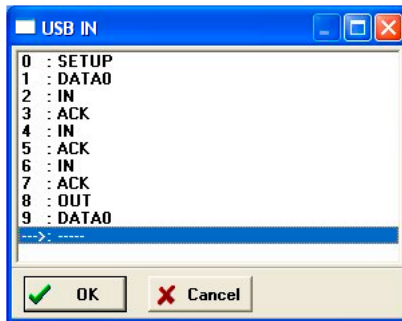
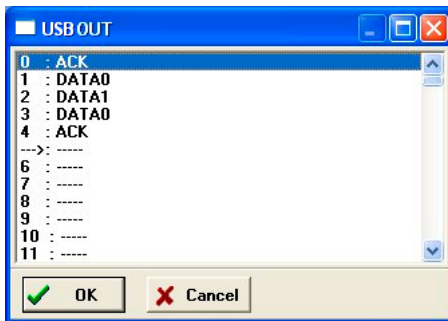
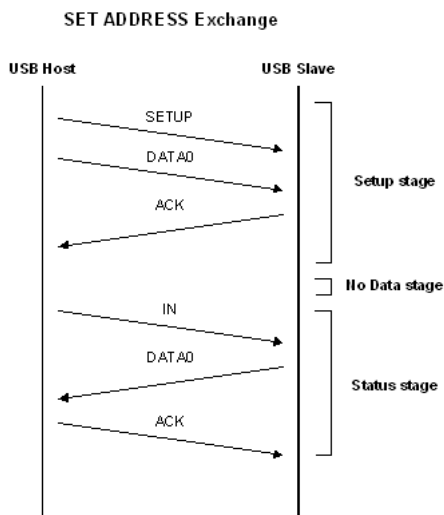

Figure 11.65 USBOUT Buffer



Now that we have gone through this device descriptor exchange, the host has an idea of what type of USB slave device it is, and next needs to give it an address. We can go through the same process for the SET ADDRESS request from the host. Once the device is addressed, you must use this address in the SETUP packets sent to the device.

Figure 11.66 Set Address Packet Exchange



USB Commands

The following USB commands are available for use with the HC08 processor.

USBCLR Command

Use the USBCLR command to flush the input and output buffers for USB simulation. This resets the buffers and clears out all packets. If the USB is currently shifting a value, this command allows the USB to finish the transfer. See USBIN command and USBOUT command for accessing the input and output buffers of the USB interface.

Syntax

```
>USBCLR
```

Example

```
>USBCLR
```

Clear input and output buffer for USB simulation

USBIN Command

The USBIN command allows the user to create packets for input into the USB. If you specify packet parameters, this command places the packet into the next slot in the USB input buffer. If no parameter is given, this command displays a pick window with the input buffer packets. Enter the packets while the window is open. An arrow points to the next input packet to the USB. The maximum number of input packets is 256.

Syntax

```
USBIN [SETUP | IN | OUT <address> <endpoint>]
USBIN [DATA0 | DATA1 <n1>...<n2>...<n3>]
USBIN [ACK/NAK/STALL]
```

Where:

<n1>...<n2>...<n3>... are the values for the data packet.

<address> is the USB address for the packet.

<endpoint> is the endpoint number for the packet.

Example

```
>USB SETUP $5A $0
```

Set the next input packet as a SETUP packet for address \$5A at the endpoint 0.

```
>USBIN DATA1 $10 $A4 $52
```

Set the next packet as a DATA1 packet with 3 data bytes \$10, \$A4, \$52

```
>USBIN ACK
```

Set the next input packet as an ACK packet.

```
>USBIN
```

Open the pick window with all the input packets.

Where:

<n> The value to be entered into the next location in the input buffer.

Example

```
>USBIN $55
```

Set the next input value to the USB to \$55

```
>USBIN
```

Pull up the data window with all the input values.

HC08 Full Chip Simulation

Configuration Procedure

Figure 11.67 USB IN Buffer Display

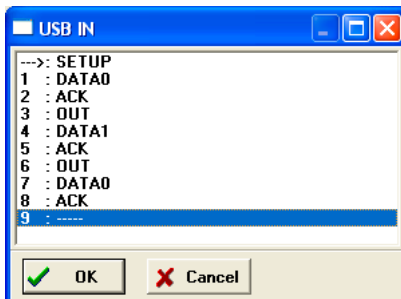

USBOUT Command

The USBOUT command displays the output buffer from the USB. A window is opened that shows all the data that the USB has shifted out. An arrow is used to point to the last output packet transmitted. The maximum number of output packets that the buffer holds is 256 bytes.

Syntax

```
>USBOUT
```

Example

```
>USBOUT
```

View packets from the output buffer for USB simulation.

Figure 11.68 USB OUT Buffer Display

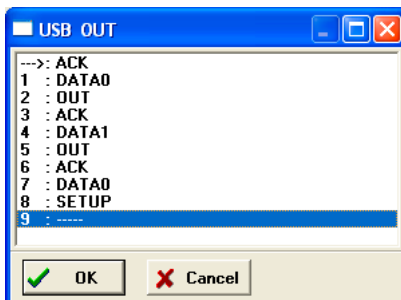

USBRESET Command

The USB RESET command simulates a USB reset from the USB connection. If the URSTD bit is clear in the CONFIG register, then a reset of the MCU occurs just as with a RESET command. If the URSTD bit is set, then a USB interrupt occurs. See the technical description of the USB peripheral in the Freescale Manual for more information.

Syntax

```
>USBRESET
```

Example

```
>USBRESET
```

Simulate USB reset of the MCU.



HC08 Full Chip Simulation

Configuration Procedure

MON08 Interface Connection

The MON08 connection setting permits a connection to Class 1-4 devices. Refer to the descriptions below for a definition of each interface class.

MON08 connection mode allows the user to debug code, as the firmware is fully resident in the FLASH of the microprocessor. The operation of all modules fully reflects the actual operation of the on-board resources.

Connection Procedure

To make the MON08 Interface debugger connection:

1. Choose the MON08 Interface option from the Set Connection dialog box

Figure 12.1 Set MON08 Interface Connection

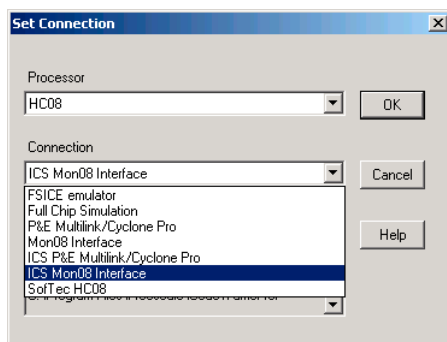

2. Click the OK button - The P&E Connection Manager window opens with its Connect Target tab selected.

MON08 Interface Connection

Connection Procedure

Figure 12.2 P&E Connection Manager Window - Connect to Target Tab

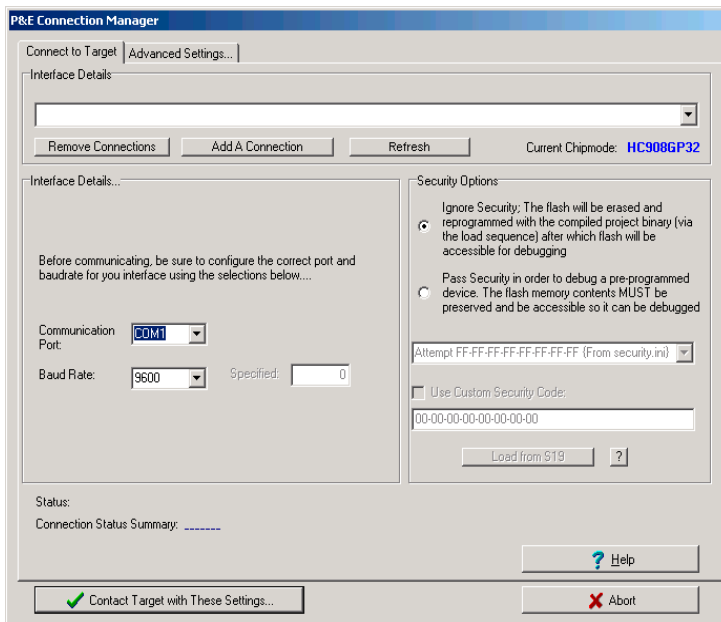

3. Access the Interface Selection dialog box by clicking the **Add A Connection** button in the Connection Manager window's - Connect Target Tab. Choose a device class corresponding to the type of interface that you are using.

Figure 12.3 Interface Selection Dialog Box

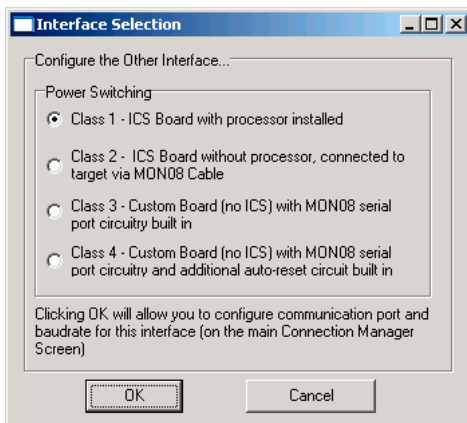

4. Define the proper communication port and baud rate setting in the Connection Manager.
5. To remove a pre-configured MON08 Interface connection, proceed to the Remove section of the connection manager. Select the interface to be removed and click on **Remove Selected Interface**.

Advanced Settings Tab

The Advanced Settings tab allows the user to set specific protocol settings. The following is an explanation of each part of the Advanced Settings tab.

Figure 12.4 P&E Connection Manager Window - Advanced Settings Tab

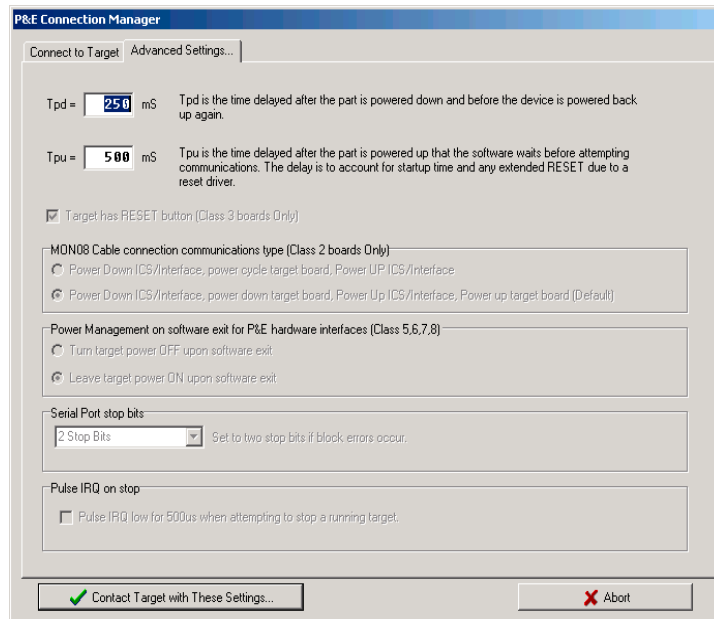

TPD and TPU Timing Listboxes

TPD and TPU Timing Listboxes set the power-up and power-down delay (respectively) that are observed when power-cycling a target for entry into Monitor Mode. These settings are only valid for devices with automatically controlled power.

Whenever power is automatically or manually switched off, the software waits for an amount of time equal to the TPD delay time before proceeding to the connection protocol. This is because a board or power supply may have capacitance which holds the power up

MON08 Interface Connection

Connection Procedure

for a short time after the supply has been switched off, but the supply voltage must reach less than 0.1v before it is turned back on if a Power-On reset is to occur.

Whenever power is automatically or manually switched on, the software waits for an amount of time equal to the Tpu delay time before attempting to contact the 68HC08 processor. This is to allow time not only for power to be fully available, but to wait until any reset driver has finally released the RESET line.

Target Has RESET Button

With a class III board, the software occasionally needs to get control of the target. On systems which are Class III boards with the monitor mode circuitry built-in (including an RS-232 driver), there is no means to reset the target to gain control. If the board has a reset button, the software can use this to gain control of the target system. If this option is checked, the software prompts the user to push the target reset button when a reset of the target system is desired. If the option is unchecked, the software asks the user to power cycle the target system to achieve a reset.

For a detailed description of the board or device classes, see [Device Class Description](#).

MON08 Cable Connection Communications Type

This selection box is valid only for Class II hardware configurations using the MON08 cable. For a detailed description of the board or device classes, see [Device Class Description](#). It allows the user to specify the sequence that the software uses to power up the ICS system. When the software tries to create a power-on reset condition, two events must occur:

1. Power of the target MCU must go below 0.1v. This means that the processor cannot be receiving power from its power pins, nor can it have a significant voltage being driven on port pins or the IRQ line, as these drive the MCU power back through these pins. It is crucial, therefore, to have the ICS and the Target both powered down at some point in time.
2. The processor MON08 configuration pins, including IRQ, must be properly driven when the target processor resets to drive it into monitor mode. If these pins are not set up properly before the processor powers up, the processor may start up in user mode.

Power Up and Power Down Radio Buttons

This is the default option and works for most, if not all, ICS08/Target Board solutions. It requires the user go through two dialog box stages, and requires more time than simply cycling the power.

1. Software automatically powers down the ICS.
2. Software asks the user to power down the board as follows:

Figure 12.5 Power Down Dialog Box

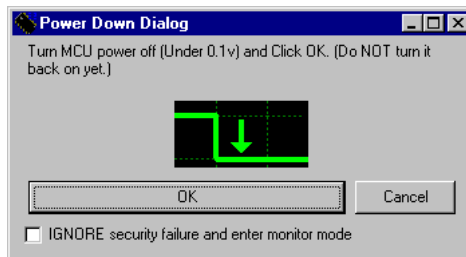

3. Software automatically powers up the ICS, which configures the processor's MON08 configuration pins.
4. Software asks the user to power up the board as follows:

Figure 12.6 Power Up Dialog Box



Turn Target Power Off and Leave Target Power On Radio Buttons

This option works for many ICS boards as well, but relies on the fact that while the ICS is powered off, it holds the target in reset until it is powered up itself and has configured the MON08 configuration pins. The sequence of events in this mode is:

1. Software automatically powers down the ICS.
2. Software asks the user to power cycle their board as follows:

Figure 12.7 Power Cycle Dialog Box

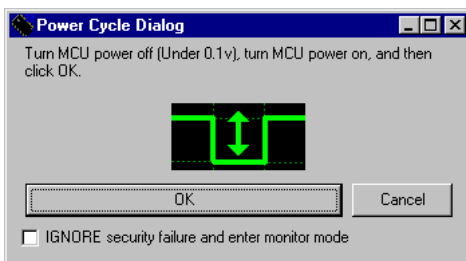

3. Software automatically powers up the ICS, which configures the processor's MON08 configuration pins.

Serial Port Stop Bits

Serial Port Stop Bits allow users of Class 1-4 devices that are experiencing unreliable communication to increase the number of stop bits to 2.

Pulse IRQ on Stop

The IRQ on Stop allows the users to execute a mechanism to stop a running HC08 microprocessor. For more information, refer to the Stop a Running HC908 Target.pdf application note that is available from P&E Microcomputer Systems website: www.pemicro.com.

Target MCU Security Bytes

One of the steps that is necessary to properly bypass security is to provide the proper security code for the information that is programmed into the part. This holds true even when the part is blank. The security code consists of the 8 values which are currently stored in Flash locations \$FFF6 - \$FFFD of the processor.

Figure 12.8 P&E Connection Manager Window - MON08 16-Pin Header Signals Tab

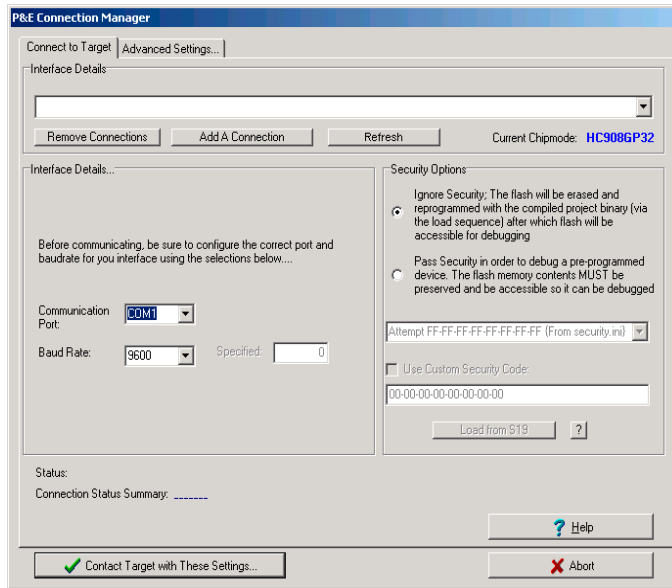

The MON08 16-Pin Header Signals tab of the P&E Connections Manager window can be used by the user to manually enter the proper security bytes via the USER setting, or to load the security bytes from the same .S19 file which was programmed. The bytes are loaded from a .S19 file by clicking the **Load from S19** button.

IGNORE Security Failure and Enter Monitor Mode

This MON08 16-Pin Header Signals tab checkbox can be used to cause the software to ignore a failure to properly pass the 68HC08 security check. If the checkbox is set, the software attempts to establish monitor mode communications regardless of the security status. As long as the Baud and Port are correct, and the device is properly powered, this allows monitor mode entry. If you ignore the security check failure, you may still use monitor mode, but the ROM/Flash is not accessible.

NOTE If a connection is not established for any reason other than security failure, the connection dialog box always appears.

STATUS Area

The status area of the MON08 16-Pin Header Signals tab consists of one status string following the **Status:** label, and seven items which list the state of the last attempt to connect to a target and pass security. The description for these items is as follows:

- **0 – ICS Hardware loopback detected:**

Every ICS or board which supports MON08 has a serial loopback in hardware which, by connecting the transmit and receive lines, automatically echoes characters from the PC. A valid character transmitted from the PC is echoed once by the loopback circuitry on the board and once by the monitor of the target processor itself. This status indicates whether the first echoed character from the hardware loopback was received when one of the security bytes was transmitted. If the status is 'N', which indicates that the character was not received, it is most likely due to one of the following reasons:

- Wrong Com Port specified.
- The baud rate specified was incorrect (probably too low).
- The ICS/Target is not connected.
- No Power to the ICS.

If this status bit is 'N', you must correct this before analyzing the rest of the status bits.

- **1 – Device echoed some security bytes:**

The monitor resident in a 68HC08 device automatically echoes every incoming character when it is in monitor mode. A valid character transmitted from the PC is echoed once by the loopback circuitry on the board and once by the monitor of the target processor itself. This status indicates whether or not the second echoed character from the monitor response was received when one of the security bytes was transmitted. If the status is 'N', which indicates that the character was not received, or not received properly, it is most likely due to one of the following reasons:

- The baud rate specified was incorrect.
- The part did not start the monitor mode security check on reset. Signals to force monitor mode may be incorrect.
- No Power to the ICS.

If this status bit is 'N', you must correct this before analyzing the rest of the status bits.

- **2 – Device echoed all security bytes:**

To pass security, the software must send 8 security bytes to the processor. The processor echoes each of these eight bytes twice. If all 8 bytes did not get the proper two-byte echo, this flag reads 'N'. Reasons for this include:

- The part did not start the monitor mode security check on reset. Signals to force monitor mode may be incorrect.
 - The baud rate specified was incorrect.
 - The processor was not reset properly. Check the **Target Hardware Type** and, if you are connecting to a class II board, check the **MON08 cable communication connections type** in the *Advanced Settings* dialog box.
- **3 – Device signaled monitor mode with a break:**

Once the processor has properly received the 8 bytes from the PC software to complete its security check, it transmits a break character to the PC signaling entry into monitor mode. This break character is sent regardless of whether the security check was successfully passed. If a break is not received from the processor, this flag reads 'N'. Reasons for this include:

 - The baud rate specified was incorrect.
 - The processor was not reset properly. Check the **Target Hardware Type**. If you are connecting to a class II board, check the **MON08 cable communication connections type** in the *Advanced Settings* dialog box.
- **4 – Device entered monitor mode:**

Once the software has received, or failed to receive, a break from the processor, it attempts to communicate with the monitor running on the M68HC08 processor. It tries to read the monitor version number by issuing a monitor mode read. If the processor fails to respond properly to this command, this flag reads 'N'.
- **5 – Reset was Power-On Reset:**

If the device properly entered monitor mode (4), the software reads the reset status register (RSR). This read does not affect the security sequence, and occurs purely for diagnostic reasons. The RSR indicates the conditions under which the processor underwent the last reset. For the software to pass the security check properly, it **MUST** first cause the processor to undergo a Power-On Reset. The software reads the RSR to determine if the last reset was indeed caused by power-on. The result of the RSR read is indicated in parentheses after the flag value. If the highest bit is not set then the reset was not a power-on reset, and the flag reads 'N'. Reasons for this include:

 - The processor did not power all the way down because power was being supplied to the processor through either the port pins, IRQ line, RESET line, or power pins.
 - The voltage driven on the power pin of the processor did not go below 0.1 volts.
 - The processor was not reset properly. Check the **Target Hardware Type**. If you are connecting to a class II board, check the **MON08 cable communication connections type** in the *Advanced Settings* dialog box.

MON08 Interface Connection

Connection Procedure

- **6 – ROM is accessible (un-secured):**

If the device properly entered monitor mode (4), the software reads locations \$FFF6-\$FFFF to determine if the processor passes the security check. Memory locations which are invalid or protected read back from the device as \$AD. If all bytes from \$FFF6-\$FFFF read a value of \$AD, it is assumed the device is secure, and the flag value is an 'N'. If all flags 0-5 register a value of 'Y' and flag 6 registers a value of 'N,' then the reset process has occurred correctly except that the security code used to pass security was incorrect. Specify the correct security code and try again, or IGNORE the security failure and erase the device. Once you erase a secured device, you must exit the software and restart it in order to pass security.

Active Mode Connection Menu Options

When the microprocessor is connected, more menu entries become available to the user.

Figure 12.9 Additional MON08 Connection Menu Options

Load...	Ctrl+L
Reset	Ctrl+R
Command Files	
Device : HC908GP32	▶
Communication...	
P&E Micro Hardware Documentation	▶
Advanced Programming/Debug Options...	
Start Expert Mode Programmer...	
View Register Files ...	

Advanced Programming/Debug Options

The Advanced Programming/Debug Options menu entry takes you to the Advanced Options dialog box, where you can configure the software settings for the Flash programming procedure.

Figure 12.10 Advanced Options Dialog Box

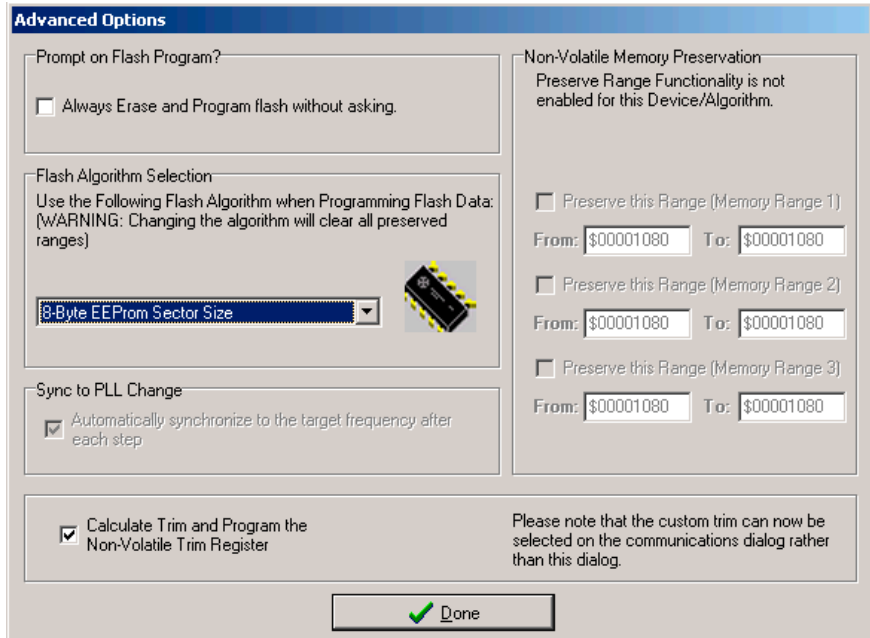

Prompt on Flash Program Checkbox

Checking **Always Erase and Program Flash without asking** lets the software transparently program the microprocessor.

Trim Options

The **Calculate Trim and Program the Non-Volatile Trim Register** checkbox enables automatic calculation and programming of the trim value in a designated Non-Volatile memory location.

Sync to PLL Change Checkbox

Sync to PLL Change is required for the software/hardware connection to synchronize with the microprocessor during the Flash erasing/programming procedure.

MON08 Interface Connection

Connection Procedure

NOTE The Non-Volatile Memory Preservation and Custom Trim functionality are only available for the M68HCS08 devices, and as such these options are disabled for all M68HC08 devices.

Start Expert Mode Programmer Option

Start Expert Mode Programmer grants the user access to P&E's graphical Flash programming utility, PROG08SZ. PROG08SZ lets an advanced user control the step-by-step execution of the Flash erase/programming procedure. See [Figure 12.11](#). More information on how to use PROG08SZ can be found on P&E Microcomputer Systems website at: www.pemicro.com.

Figure 12.11 PROG08SZ Programmer Window

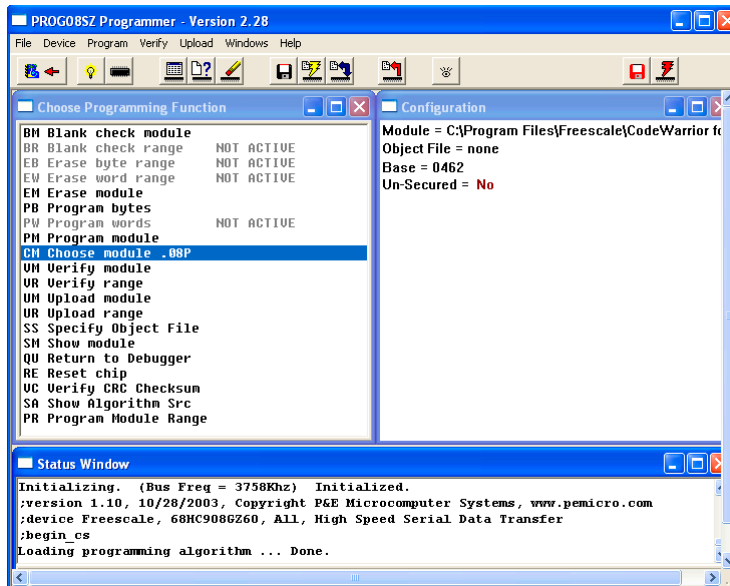

View Register Files Option

The *View Register Files* menu option also gives the user the option of running the register file viewer/editor. If register files are available for the device that you have chosen, the **Choose a Register Block** window (see [Figure 12.12](#)) opens. You may also open it by entering the R command in the Command Window command line.

Figure 12.12 Choose A Register Block Window

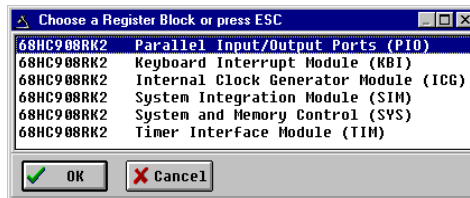

If register files are installed on the host computer, selecting a block brings up the Register Block register listing (see [Figure 12.13](#)), which shows a list of the associated registers, their addresses, and their descriptions. This begins interactive setup of system registers such as I/O, timer, and COP watchdog.

Figure 12.13 Timer Interface Module Register Listing

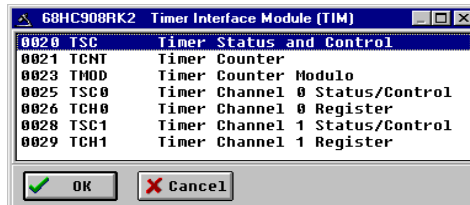

Selecting a file brings up the Register Window (see [Figure 12.14](#)), which displays the values and significance for each bit in the register. The registers can be viewed and their values modified, and the values can be stored back into debugger memory.

Figure 12.14 Register Window

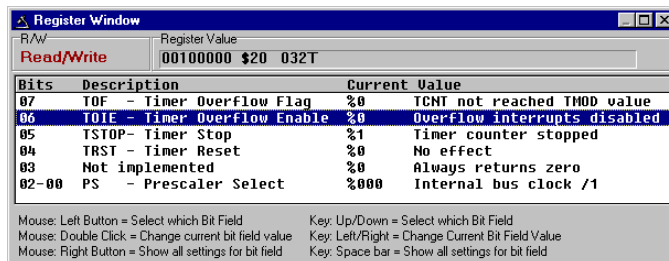

Device Class Description

The following device information summarizes the different classes of boards available to the user. Detailed information about specific devices is available from Freescale.

Class 1 Device

ICS Board with processor installed. This is the standard and most common configuration of the ICS08 boards. In this configuration, the processor is resident in one of the sockets on the ICS board itself. The processor can be debugged and programmed in this configuration, and an emulation cable containing all the processor I/O signals can be connected to the user's MCU development board. In this configuration, the ICS board hardware can automatically power up and down the processor in order to pass security in the simplest fashion. The user must be sure not to provide power from the MCU development board, up through the emulation cable, to the processor pins themselves, when this dialog box appears. This is so that the software, when attempting to establish communications, can fully power the processor down. The software running on the PC controls power to the user's MCU development board via the serial port DTR line.

Class 2 Device

ICS Board without processor, connected to the user's microprocessor system via MON08 Cable. In this configuration, there is no processor resident in any of the sockets of the ICS board itself. The processor is mounted down in the user's MCU system. The connection from the ICS board to the user's MCU system is accomplished via the 16-pin MON08 connector. In this configuration, since the ICS does not control power to the processor, the user is prompted to turn the processor's power supply on and off. Turning off the power supply is necessary to pass the initial security mode check and access the Flash on the processor. A simple reset is not enough; to pass the security check, you must first force the processor to encounter a POR (power-on reset) which requires that the processor's voltage dip below 0.1v. Once security is passed, resetting the device or re-entering the software is easier.

Class 3 Device

Custom Board (no ICS) with MON08 serial port circuitry built in. In this configuration, the ICS board is not used at all. The user must provide a serial port connection from the PC, and provide all hardware configurations necessary to force the processor into MON08 mode upon reset. This includes resets both internal and external to the processor. In this configuration, because the software does not directly control power to the processor, the user is prompted to turn the processor's power supply on and off. The user is be prompted to turn power on and off to reset the microprocessor, as the PC doesn't have control of the microprocessor reset. Turning off the power supply is necessary to pass the initial security

mode check and access the Flash on the processor. A simple reset is not enough; to pass the security check, you must first force the processor to encounter a POR (power-on reset) which requires that the processor's voltage dip below 0.1v. Once security is passed, resetting the device or re-entering the software is easier. Class 3 selection also applies to use of the ICS board with the two-pin blank part programming connector.

Class 4 Device

Custom Board (no ICS) with MON08 serial port circuitry and additional auto-reset circuit built in. In this configuration, the ICS board is not used at all. The user must provide a serial port connection from the PC and all hardware configuration necessary to force the processor into MON08 mode upon reset. In addition, the user must include an extra circuit which allows the reset line of the processor to be driven low from the DTR line of the serial port connector (Pin 4 on a DB9). The following diagram shows the additional connection needed to reset from a DB9 serial connector.

Figure 12.15 Reset Connection

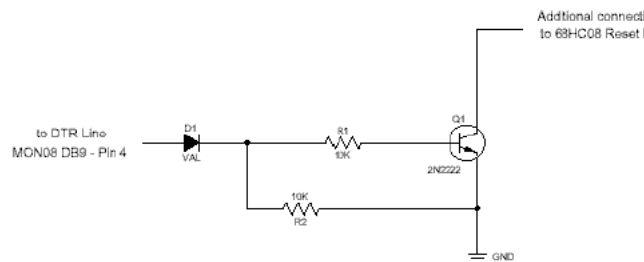

In this configuration, because the software does not directly control power to the processor, the user is prompted to turn the processor's power supply on and off. Turning off the power supply is necessary to pass the initial security mode check and access the Flash on the processor. A simple reset is not enough; to pass the security check, you must first force the processor to encounter a POR (power-on reset) which requires the processor's voltage to dip below 0.1v. Once security is passed, resetting the device is facilitated by the above circuitry.



MON08 Interface Connection

Device Class Description

ICS MON08 Interface Connection

ICS Mode

In-Circuit Simulation (ICS) Mode is a P&E Microcomputer Systems mode of operation that is a hybrid between In-Circuit Debugging, and Full Chip simulation. P&E has combined the benefits of each of these modes, while minimizing their respective deficiencies.

ICS mode simulates the CPU core instructions on the user's PC. However, Inputs/Outputs are read directly from the user's development device, and certain modules are run on the actual device. Any instructions that affect an I/O location, for example, `lda PORTA` or `sta PORTA`, also use data from the real device. This allows for all the benefits of full chip simulation (Cycle by Cycle accuracy, unlimited breakpoints, and speed, to name just a few), while allowing the obvious benefit of garnering relevant signals from actual hardware.

In-Circuit simulation requires a user to have a connected MCU Device, be it a development board, prototype hardware, or simply a device placed in a simple circuit on a breadboard. Once connection is established, the P&E Interface loads a `.MON` file to the microcontroller itself. This `.MON` file is the ICS-Kernel: it constantly runs on the device, and interacts with the P&E software to provide information about changing I/O and any peripherals that are running on the device itself.

The following modules are run on the actual device when in ICS mode, and as such their Simulation commands become unnecessary, and therefore do not function:

I/O ports, SCI, SPI, IRQ, ADC, LCD, KBI.

All other modules function as fully simulated modules. For information about relevant simulation commands, see the [HC08 Full Chip Simulation](#) section.

Connection Procedure

To select the ICS MON08 Interface connection:

1. Choose the ICS MON08 Interface option from the set connection dialog box, as shown in [Figure 13.1](#).
2. Click the OK button to open the P&E Connection Manager Window.

Figure 13.1 ICS MON08 Set Connection Dialog Box

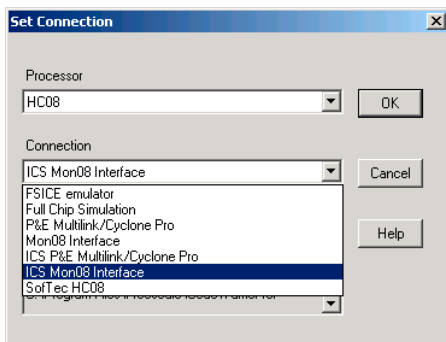
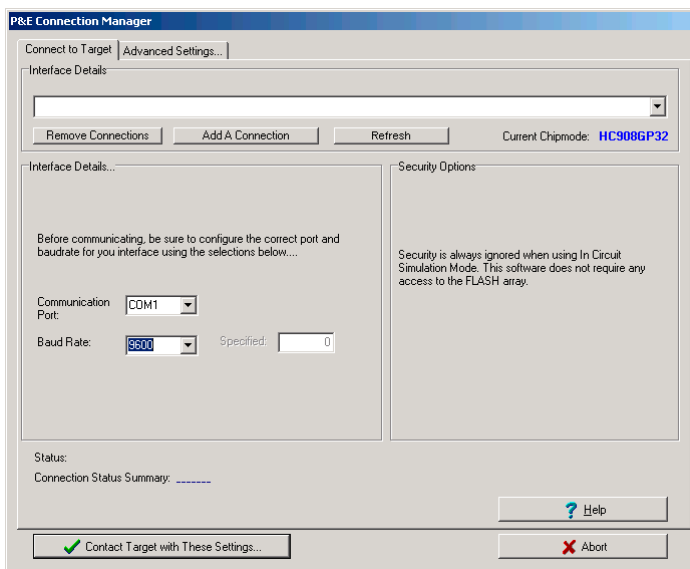
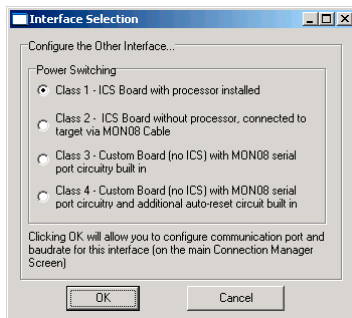

Figure 13.2 P&E Connection Manager Window - Connect to Target Tab



3. Access the Interface Selection Manager assistant by clicking on the **Add A Connection** button in the P&E Connection Manager Window ([Figure 13.2](#)). Choose a device class that corresponds to the Interface that you are using.

Figure 13.3 Interface Selection Dialog Box



4. Define the proper communication port and baud rate setting in the Connection Manager. See [Figure 13.3](#).
5. To remove a pre-configured ICS MON08 Interface, go to the Remove section of the connection manager. Select the interface to be removed and click on **Remove Selected Interface**.

Advanced Settings Tab

The P&E Connection Manager window's **Advanced Settings** tab allows the user to set specific protocol settings. The following is an explanation of each part of the advanced settings tab.

Figure 13.4 P&E Connection Manager Window - Advanced Settings Tab

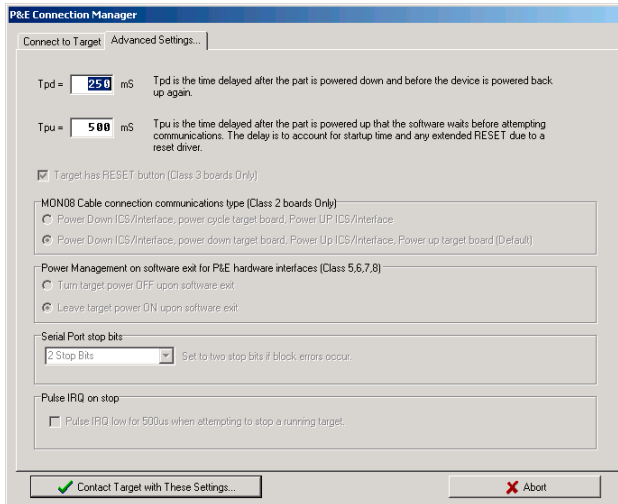

Tpd and Tpu Timing Textboxes

Tpu and Tpd set the power-up and power-down delay (respectively) that is observed when power-cycling a target for entry into Monitor Mode. These settings are only valid for devices with automatically controlled power.

Whenever power is automatically switched off, or is manually requested to be switched off, the software waits for an amount of time equal to the Tpd delay time before proceeding to the connection protocol. This is because a board or power supply may have capacitance which holds the power up for a short time after the supply has been switched off, but the supply voltage must reach less than 0.1v before it is turned back on if a Power-On reset is to occur.

Whenever power is automatically switched on, or is manually requested to be switched on, the software waits for an amount of time equal to the Tpu delay time before attempting to contact the 68HC08 processor. This is to allow time not only for power to be fully available, but to wait until any reset driver has finally released the RESET line.

Target Has RESET Button

In Class III boards, the software occasionally needs to get control of the target. For a detailed definition of board classes, see [Device Class Description](#). On systems which are Class III boards with the monitor mode circuitry built-in (including RS-232 driver), there is no means to reset the target to gain control. If the board has a reset button, the software can use this to gain control of the target system. If this option is checked, the software prompts the user to push the target reset button when a reset of the target system is desired. If the option is unchecked, the software prompts the user to power cycle the target system to achieve a reset.

MON08 Cable Connection Communications Type

This selection box is valid only for Class II hardware configurations using the MON08 cable. For a detailed definition of board classes, see [Device Class Description](#). It allows the user to specify the sequence that the software uses to power up the ICS system. When the software tries to create a power-on reset condition, two events must occur:

1. Power of the target MCU must go below 0.1v. This means that the processor cannot be receiving power from its power pins, nor can it have a significant voltage being driven on port pins or the IRQ line, as these drive the MCU power back through these pins. It is crucial, therefore, to have the ICS and the Target both powered down at some point in time.
2. The processor MON08 configuration pins, including IRQ, must be properly driven when the target processor resets to drive it into monitor mode. If these pins are not set up properly before the processor powers up, the processor may start up in user mode.

Power Up and Power Down Radio Buttons

Power Down ICS button prompts the user to power down the board, **Power Up ICS** button prompts the user to power up their board.

This is the default option and works for most, if not all, ICS08/Target Board solutions. It requires the user go through two dialog box stages, and requires more time than simply cycling the power.

1. Software automatically powers down the ICS.
2. Software prompts the user to power down the board as follows:

ICS MON08 Interface Connection

Connection Procedure

Figure 13.5 Power Down Dialog Box

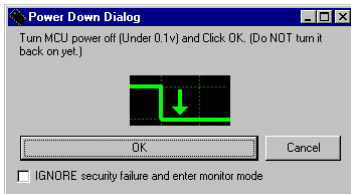

3. Software automatically powers up the ICS, which configures the processor's MON08 configuration pins.
4. Software asks the user to power up the board as follows:

Figure 13.6 Power Up Dialog Box

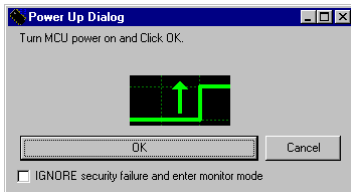

Cycle Power Radio Button

Power Down ICS button asks the user to power cycle their board. **Power UP ICS** button does the opposite.

This option works for many ICS boards as well, but relies on the fact that while the ICS is powered off, it holds the target in reset until it is powered up itself and has configured the MON08 configuration pins. The sequence of events in this mode is:

1. Software automatically powers down the ICS.
2. Software asks the user to power cycle their board as follows:

Figure 13.7 Power Cycle Dialog Box

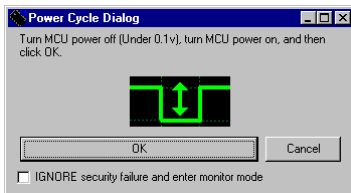

3. Software automatically powers up the ICS, which configures the processors MON08 configuration pins.

Serial Port Stop Bits

Serial Port Stop Bits allow users of Class 1-4 devices that are experiencing unreliable communication to increase the number of stop bits to 2.

Pulse IRQ on Stop

The IRQ on Stop allows the users to execute a mechanism to stop a running HC08 microprocessor. For more information, refer to the *Stop a Running HC908 Target.pdf* application note that is available from P&E Microcomputer Systems website: www.pemicro.com.

Target MCU Security Bytes

In ICS mode, the user's code is simulated on the PC, and not run from the Non-Volatile memory of the device. Therefore, there is no need to pass security in this mode of operation.

IGNORE Security Failure and Enter Monitor Mode

Use this checkbox to cause the software to ignore a failure to properly pass the M68HC08 security check. If the checkbox is set, the software attempts to establish monitor mode communications regardless of the security status. As long as the Baud and Port are correct, and the device has been properly powered, this allows monitor mode entry. By ignoring the security check failure you may still use monitor mode, but the ROM/Flash is not accessible.

NOTE If a connection is not established for any reason other than security failure, the connection dialog box always appears.

STATUS Area

The status area of the P&E Connections Manager window consists of one status string following the **Status:** label, and seven items which list the state of the last attempt to connect to a target and pass security. The description for these items is as follows:

- **0 – ICS Hardware loopback detected:**

Every ICS or board which supports MON08 has a serial loopback in hardware which, by connecting the transmit and receive lines, automatically echoes characters from the PC. A valid character transmitted from the PC is echoed once by the loopback circuitry on the board and once by the monitor of the target processor itself.

ICS MON08 Interface Connection

Connection Procedure

This status indicates whether or not the first echoed character from the hardware loopback was received when one of the security bytes was transmitted. If the status is 'N', which indicates that the character was not received, it is most likely due to one of the following reasons:

- Wrong Com Port specified.
- The baud rate specified was incorrect (probably too low).
- The ICS/Target is not connected.
- No Power to the ICS.

If this status bit returns an 'N', you must correct this before analyzing the reset of the status bits.

- **1 – Device echoed some security bytes:**

The monitor resident in a M68HC08 device automatically echoes every incoming character when it is in monitor mode. A valid character transmitted from the PC is echoed once by the loopback circuitry on the board and once by the monitor of the target processor itself. This status indicates whether or not the second echoed character from the monitor response was received when one of the security bytes was transmitted. If the status is 'N', which indicates that the character was not received, or not received properly, it is most likely due to one of the following reasons:

- The baud rate specified was incorrect.
- The part did not start the monitor mode security check on reset. Signals to force monitor mode may be incorrect.
- No Power to the ICS.

If this status bit returns an 'N', you must correct this before analyzing the reset of the status bits.

- **2 – Device echoed all security bytes:**

To pass security, the software must send eight security bytes to the processor. The processor echoes each of these eight bytes twice. If all eight bytes did not get the proper two-byte echo, this flag returns an 'N'. Reasons for this include:

- The part did not start the monitor mode security check on reset. Signals to force monitor mode may be incorrect.
- The baud rate specified was incorrect.
- The processor was not reset properly. Check the **Target Hardware Type** and if you are connecting to a class II board, check the **MON08 cable communication connections type** in the *Advanced Settings* dialog box.

- **3 – Device signaled monitor mode with a break:**

Once the processor has properly received the eight bytes from the PC software to complete its security check, it transmits a break character to the PC signaling entry into monitor mode. This break character is sent regardless of whether the security

check was successfully passed. If a break character is not received from the processor, this flag returns an 'N'. Reasons for this include:

- The baud rate specified was incorrect.
- The processor was not reset properly. Check the **Target Hardware Type**. If you are connecting to a class II board, check the **MON08 cable communication connections type** in the *Advanced Settings* dialog box.

- **4 – Device entered monitor mode:**

Once the software receives, or fails to receive, a break character from the processor, it attempts to communicate with the monitor running on the M68HC08 processor. It tries to read the monitor version number by issuing a monitor mode read. If the processor fails to respond properly to this command, this flag returns an 'N'.

- **5 – Reset was Power-On Reset:**

If the device properly entered monitor mode (4), the software reads the reset status register (RSR). This read does not affect the security sequence, and occurs purely for diagnostic reasons. The RSR indicates the conditions under which the processor underwent the last reset. For the software to pass the security check properly, it MUST first cause the processor to undergo a Power-On Reset. The software reads the RSR to determine if the last reset was indeed caused by power-on. The result of the RSR read is indicated in parentheses after the flag value. If the highest bit is not set then the reset was not a power-on reset, and the flag indicates an 'N'. Reasons for this include:

- The processor did not power all the way down because power was being supplied to the processor through either the port pins, IRQ line, RESET line, or power pins.
- The voltage driven on the power pin of the processor did not go below 0.1 volts.
- The processor was not reset properly. Check the **Target Hardware Type**. If you are connecting to a class II board, check the **MON08 cable communication connections type** in the *Advanced Settings* dialog box.

- **6 – ROM is accessible (un-secured):**

If the device properly entered monitor mode (4), the software reads locations \$FFF6-\$FFFF to determine if the processor passes the security check. Memory locations which are invalid or protected read back from the device as \$AD. If all bytes from \$FFF6-\$FFFF read a value of \$AD, it is assumed the device is secure, and the flag value is an 'N'. If all flags 0-5 register a value of 'Y' and flag 6 register a value of 'N,' then the reset process has gone correctly except that the security code used to pass security was incorrect. Specify the correct security code and try again, or IGNORE the security failure and erase the device. Once you erase a secured device, you must exit the software and restart it in order to pass security.

Active Mode Connection Menu Options

When the microprocessor is connected, more Connection menu entries become available to the user.

Figure 13.8 Additional Connection Menu Options



Advanced Programming/Debug Options

The Advanced Programming/Debug Options menu entry take you to the Advanced Options dialog box, where you can configure the software settings for the Flash programming procedure.

Figure 13.9 Advanced Options Dialog Box

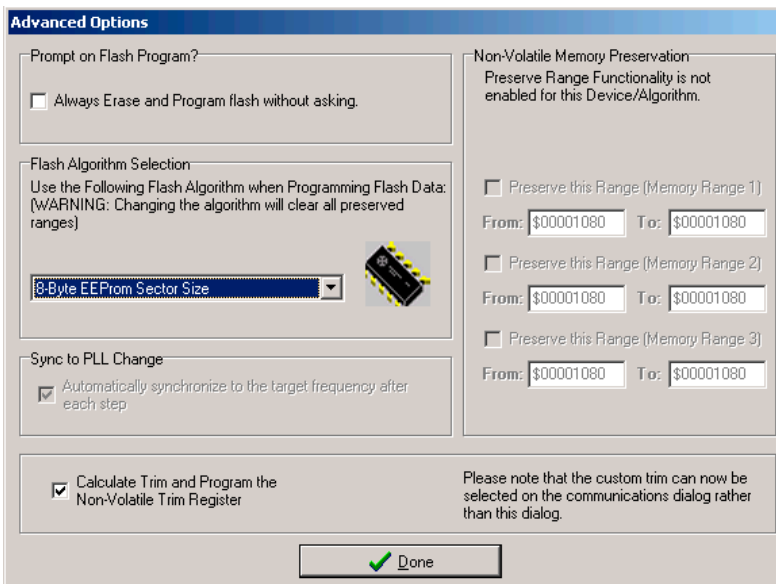

Prompt on Flash Program Checkbox

Checking **Always Erase and Program Flash without asking** lets the software transparently program the microprocessor.

Trim Options

The **Calculate Trim and Program the Non-Volatile Trim Register** checkbox enables automatic calculation and programming of the trim value in a designated non-volatile memory location.

Sync to PLL Change Checkbox

Sync to PLL Change is required for the software/hardware connection to synchronize with the microprocessor during the Flash erasing/programming procedure.

NOTE The Non-Volatile Memory Preservation and Custom Trim functionality are only available for the M68HCS08 devices, and as such these options are disabled for all M68HC08 devices.

Start Expert Mode Programmer Option

Start Expert Mode Programmer grants the user access to P&E's graphical Flash programming utility, PROG08SZ. PROG08SZ lets an advanced user control the step-by-step execution of the Flash erase/programming procedure. See [Figure 13.10](#). For more information on using PROG08SZ, refer to P&E Microcomputer Systems website at: www.pemicro.com.

ICS MON08 Interface Connection

Connection Procedure

Figure 13.10 PROG08SZ Programmer Window

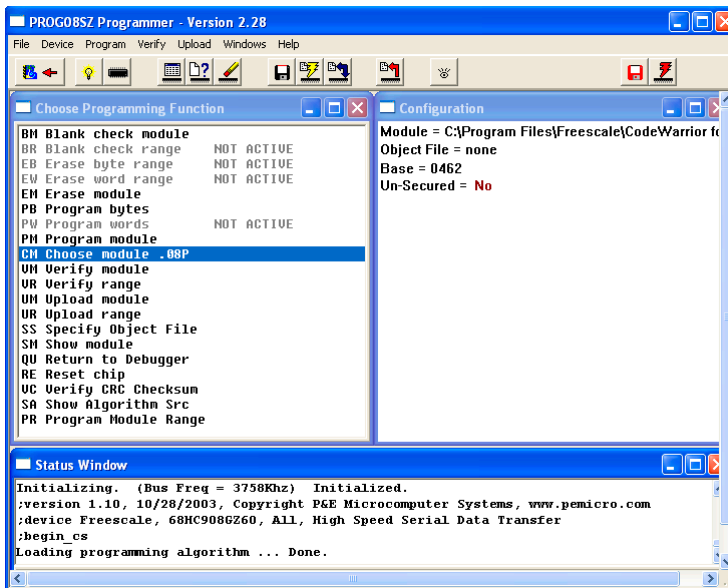

View Register Files Option

The *View Register Files* menu option also gives the user the option of running the register file viewer/editor. If register files are available for the device that you have chosen, the **Choose a Register Block** window (see [Figure 13.11](#)) opens. You may also open it by entering the R command in the Command Window command line.

Figure 13.11 Choose A Register Block Dialog Box

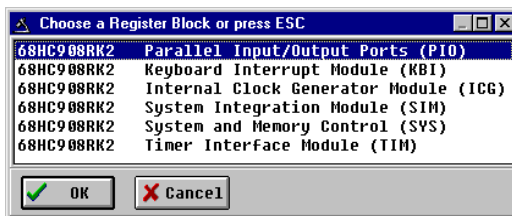

If register files are installed on the host computer, selecting a block brings up the Register Block register listing (see [Figure 13.12](#)), which shows a list of the associated registers, their addresses, and their descriptions. This begins interactive setup of system registers such as I/O, timer, and COP watchdog.

Figure 13.12 Timer Interface Module Register Listing

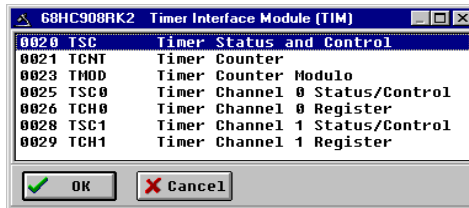

Selecting a file brings up the Register Window (see [Figure 13.13](#)), which displays the values and significance for each bit in the register. The registers can be viewed and their values modified, and the values can be stored back into debugger memory.

Figure 13.13 Register Window

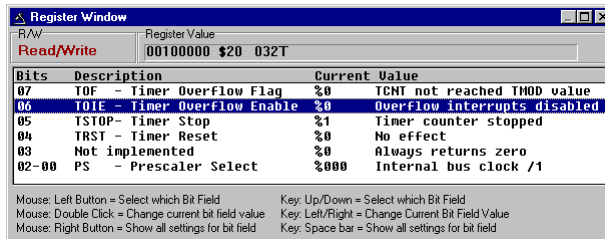

Device Class Description

The following device information summarizes the different classes of boards available to the user. Detailed information about specific devices is available from Freescale.

Class 1 Device

ICS Board with processor installed. This is the standard and most common configuration of the ICS08 boards. In this configuration, the processor is resident in one of the sockets on the ICS board itself. The processor can be debugged and programmed in this configuration, and an emulation cable containing all the processor I/O signals can be connected to the user's MCU development board. In this configuration, the ICS board hardware can automatically power up and down the processor in order to pass security in the simplest fashion. The user has to be sure not to provide power from the MCU development board, up through the emulation cable, to the processor pins themselves, when this dialog box appears. This is so that the software, when attempting to establish communications, can fully power the processor down. The software running on the PC controls power to the user's MCU development board via the serial port DTR line.

Class 2 Device

ICS Board without processor, connected to the user's microprocessor system via MON08 Cable. In this configuration, there is no processor resident in any of the sockets of the ICS board itself. The processor is mounted down in the user's MCU system. The connection from the ICS board to the user's MCU system is accomplished via the 16-pin MON08 connector. In this configuration, since the ICS does not control power to the processor, the user is prompted to turn the processor's power supply on and off. Turning off the power supply is necessary to pass the initial security mode check and access the Flash on the processor. A simple reset is not enough; to pass the security check, you must first force the processor to encounter a POR (power-on reset) which requires that the processor's voltage dip below 0.1v. Once security is passed, resetting the device or re-entering the software is easier.

Class 3 Device

Custom Board (no ICS) with MON08 serial port circuitry built in. In this configuration, the ICS board is not used at all. The user must provide a serial port connection from the PC, and provide all hardware configuration necessary to force the processor into MON08 mode upon reset. This includes resets both internal and external to the processor. In this configuration, because the software does not directly control power to the processor, the user is prompted to turn the processor's power supply on and off. The user is also prompted to turn power on and off to reset the microprocessor, as the PC has no control of the microprocessor reset. Turning off the power supply is necessary to pass the initial security mode check and access the Flash on the processor. A simple reset is not enough; to pass the security check, you must first force the processor to encounter a POR (power-on reset) which requires that the processor's voltage dip below 0.1v. Once security is passed, resetting the device or re-entering the software is easier. Class 3 selection also applies to use of the ICS board with the two-pin blank part programming connector.

Class 4 Device

Custom Board (no ICS) with MON08 serial port circuitry and additional auto-reset circuit built in. In this configuration, the ICS board is not used at all. The user must provide a serial port connection from the PC and all hardware configuration necessary to force the processor into MON08 mode upon reset. In addition, the user must include an extra circuit which allows the reset line of the processor to be driven low from the DTR line of the serial port connector (Pin 4 on a DB9). The following diagram shows the additional connection needed to reset from a DB9 serial connector.

Figure 13.14 Reset Connection

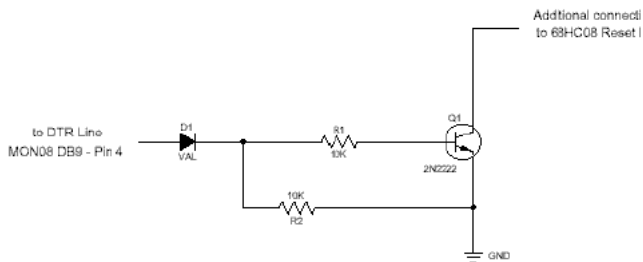

In this configuration, because the software does not directly control power to the processor, the user is prompted to turn the processor's power supply on and off. Turning off the power supply is necessary to pass the initial security mode check and access the Flash on the processor. A simple reset is not enough; to pass the security check, you must first force the processor to encounter a POR (power-on reset) which requires the processor's voltage to dip below 0.1v. Once security is passed, resetting the device is facilitated by the above circuitry.



ICS MON08 Interface Connection

Device Class Description

HC08 P&E Multilink/Cyclone Pro Connection

The HC08 P&E Multilink/Cyclone Pro Connection setting permits a connection to Class 5, 7 or 8 devices. See [Device Class Description](#) for a definition of each interface class. HC08 P&E Multilink/Cyclone Pro connection mode allows the user to debug code, as the firmware is fully resident in the FLASH of the microprocessor. The operation of all modules fully reflects the actual operation of the on-board resources.

Connection Procedure

To select the P&E Multilink/Cyclone Pro connection:

1. Select the *Component > Set Connection* menu command.
2. Choose the P&E Multilink/Cyclone Pro option from the Set Connection dialog box, as shown in [Figure 14.1](#).

Figure 14.1 Set Connections Dialog Box - P&E Multilink/Cyclone Pro Selected

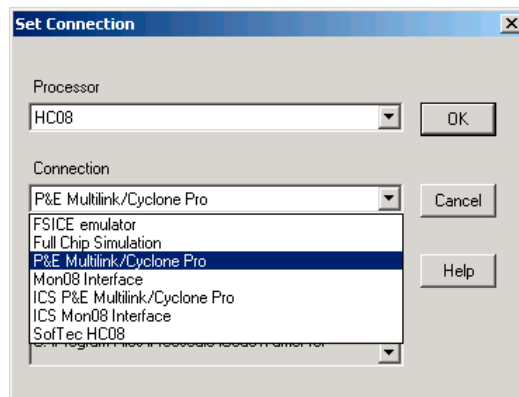

3. Click the *OK* button - The Connection Manager Window opens with the Connect to Target Tab exposed, as shown in [Figure 14.2](#).

HC08 P&E Multilink/Cyclone Pro Connection Connection Procedure

Figure 14.2 P&E Connection Manager Window - Connect to Target Tab

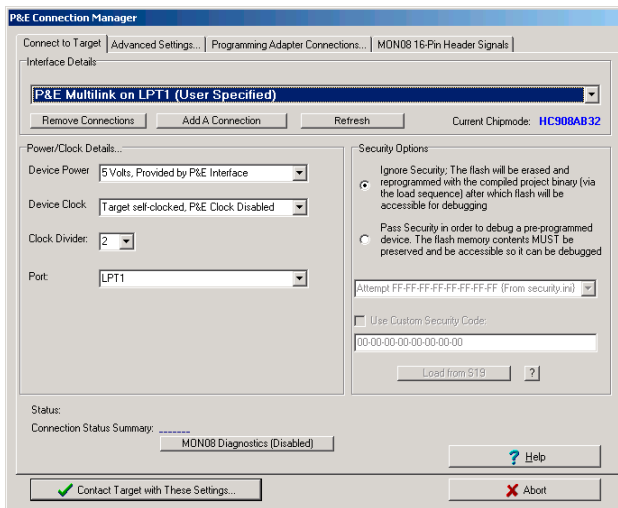

- The device power selection allows the user to specify whether the target is 2, 3, or 5 Volts, and whether this power is switched/generated by the P&E interface or if it is separately supplied to the target and under user control. If it is under user control, the software uses dialog boxes to ask the user to power the target up and down when necessary (similar to Class II-IV). See [Figure 14.3](#).

Figure 14.3 Device Power Selection List

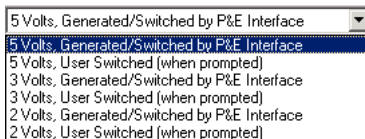
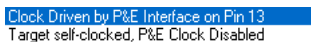

Figure 14.4 HC08 Device Clock Selection Box



- The device clock menu allows two options, as shown in [Figure 14.4](#).
 - P&E provides clock to target
 - The device has its own clock
- Click on *Refresh*, which displays all P&E devices that are automatically detected, such as Cyclone Pro USB, Cyclone Pro Ethernet and USB-ML-MON08 Multilink. See [Figure 14.2](#).

7. To add a serial/parallel port P&E device such as Cyclone Pro Serial, MON08 Multilink and Cyclone Pro Ethernet (IP outside of subnet mask), proceed to the Interface Selection Window by pressing the **Add A Connection** button on this tab of the Connection Manager window. See [Figure 14.5](#). For more information about configuring Cyclone Pro for ethernet operation, refer to the Cyclone Pro User's Manual.

Figure 14.5 Interface Selection Dialog Box

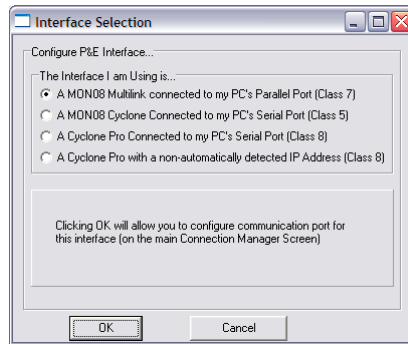

8. To remove a manually configured interface, click on the **Remove Connection** button on this tab of the Connection Manager window and choose the interface to be deleted. See [Figure 14.6](#).

Figure 14.6 Connection Manager Dialog Box - Remove A Manually Configured Multilink/Cyclone Pro Interface

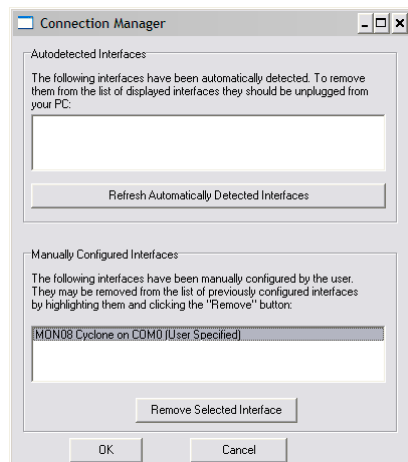

Advanced Settings Tab

The Advanced Settings tab of the P&E Connection Manager window allows the user to set specific protocol settings. The following is an explanation of each part of the advanced settings dialog box.

Figure 14.7 Advanced Settings Tab

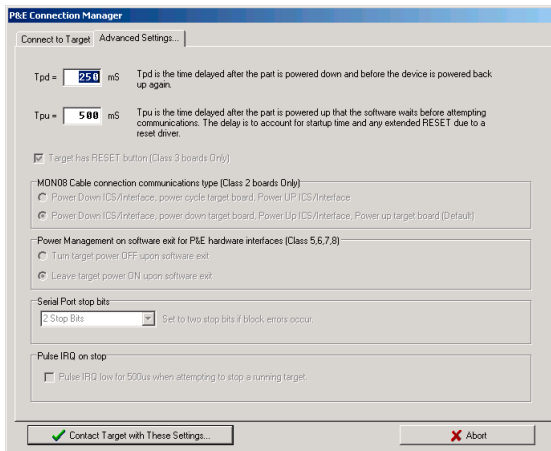

Tpd And Tpu Timing Textboxes

Tpd and Tpu set the power-down and power-up delay that is observed when power-cycling a target for entry into Monitor Mode. These settings are only valid for devices with automatically controlled power.

Whenever power is automatically switched off, or is manually requested to be switched off, the software waits for an amount of time equal to the Tpd delay time before proceeding to the connection protocol. This is because a board or power supply may have capacitance which holds the power up for a short time after the supply has been switched off, but the supply voltage must reach less than 0.1v before it is turned back on if a Power-On reset is to occur.

Whenever power is automatically switched on, or is manually requested to be switched on, the software waits for an amount of time equal to the Tpu delay time before attempting to contact the 68HC08 processor. This is to allow time not only for power to be fully available, but to wait until any reset driver has finally released the RESET line.

Target Has RESET Button Checkbox

With Class III boards, the software occasionally needs to get control of the target. On systems which are Class III boards with the monitor mode circuitry built-in (including RS-232 driver), there is no means to reset the target to gain control. If the board has a reset button, the software can use this to gain control of the target system. If this option is checked, the software prompts the user to push the target reset button when a reset of the target system is desired. If the option is unchecked, the software prompts the user to power cycle the target system to achieve a reset.

MON08 Cable Connection Communications Type

This selection box is valid only for Class II hardware configurations using the MON08 cable. It allows the user to specify the sequence that the software uses to power up the ICS system. When the software tries to create a power-on reset condition, two events must occur:

1. Power of the target MCU must go below 0.1v. This means that the processor cannot be receiving power from its power pins, nor can it have a significant voltage being driven on port pins or the IRQ line, as these drive the MCU power back through these pins. It is crucial, therefore, to have the ICS and the Target both powered down at some point in time.
2. The processor MON08 configuration pins, including IRQ, must be properly driven when the target processor resets to drive it into monitor mode. If these pins are not set up properly before the processor powers up, the processor may start up in user mode.

Power Up and Power Down Radio Buttons

Power Down ICS button prompts the user to power down the board. **Power Up ICS** prompts the user to power up the board.

This is the default option and works for most, if not all, ICS08/Target Board solutions.

1. Software automatically powers down the ICS.
2. Software asks the user to power down the board as follows:

Figure 14.8 Power Down Dialog Box

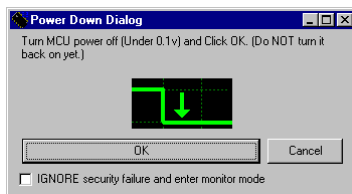

HC08 P&E Multilink/Cyclone Pro Connection Connection Procedure

3. Software automatically powers up the ICS, which configures the processor's MON08 configuration pins.
4. Software asks the user to power up the board as follows:

Figure 14.9 Power Up Dialog Box



Cycle Power Down/Up Radio Button

These buttons ask the user to power cycle their board.

This option works for many ICS boards as well, but relies on the fact that while the ICS is powered off, it holds the target in reset until it is powered up itself and has configured the MON08 configuration pins. The sequence of events in this mode is:

1. Software automatically powers down the ICS.
2. Software asks the user to power cycle their board as follows:

Figure 14.10 Power Cycle Dialog Box

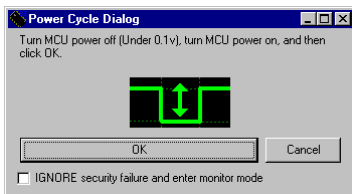

3. Software automatically powers up the ICS, which configures the processor's MON08 configuration pins.

Serial Port Stop Bits

Serial Port Stop Bits allow users of Class 1-4 devices that are experiencing unreliable communication to increase the number of stop bits to 2.

Pulse IRQ on Stop

The IRQ on Stop allows the users to execute a mechanism to stop a running HC08 microprocessor. For more information, refer to the *Stop a Running HC908 Target.pdf* application note that is available from the P&E Microcomputer Systems website: www.pemicro.com.

Target MCU Security Bytes

One of the steps that is necessary to properly bypass security is to provide the proper security code for the information that is programmed into the part. This holds true even when the part is blank. The security code consists of the 8 values, which are currently stored in Flash locations \$FFF6 - \$FFFD of the processor.

Figure 14.11 P&E Connection Manager Window - P&E Multilink on LPT1 Interface

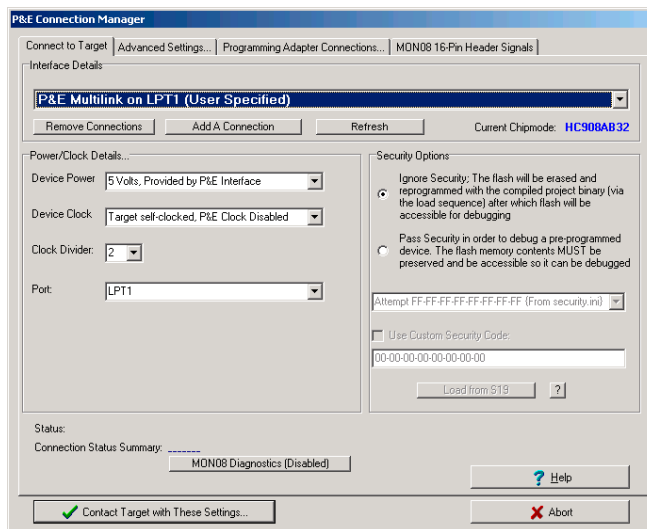

This window can be used to manually enter the proper security bytes via the **USER** setting, or to load the security bytes from the same .S19 file which was programmed. The bytes are loaded from a .S19 file by clicking the **Load from S19** button.

IGNORE Security Failure and Enter Monitor Mode

Use this checkbox to make the software ignore a failure so that it can properly pass the M68HC08 security check. If the checkbox is set, the software attempts to establish

HC08 P&E Multilink/Cyclone Pro Connection

Connection Procedure

monitor mode communications regardless of the security status. As long as the Baud and Port are correct, and the device has been properly powered, monitor mode entry is allowed. By ignoring the security check failure you can still use monitor mode, but the ROM/Flash are not accessible.

NOTE If a connection is not established for any reason other than security failure, the connection dialog box always appears.

STATUS Area

The status area of the P&E Connections Manager window consists of one status string following the **Status:** label, and seven items which list the state of the last attempt to connect to a target and pass security. The description for these items is as follows:

- **0 – ICS Hardware loopback detected:**

Every ICS or board which supports MON08 has a serial loopback in hardware which, by connecting the transmit and receive lines, automatically echoes characters from the PC. A valid character transmitted from the PC is echoed once by the loopback circuitry on the board and once by the monitor of the target processor itself. This status indicates whether the first echoed character from the hardware loopback was received when one of the security bytes was transmitted. If the status is 'N', which indicates that the character was not received, it is most likely due to one of the following reasons:

- Wrong Com Port specified.
- The baud rate specified was incorrect (probably too low).
- The ICS/Target is not connected.
- No Power to the ICS.

If this status bit returns an 'N', you must correct this before analyzing the rest of the status bits.

- **1 – Device echoed some security bytes:**

The monitor resident in a M68HC08 device automatically echoes every incoming character when it is in monitor mode. A valid character transmitted from the PC is echoed once by the loopback circuitry on the board and once by the monitor of the target processor itself. This status indicates whether the second echoed character from the monitor response was received when one of the security bytes was transmitted. If the status is 'N', which indicates that the character was not received, or not received properly, it is most likely due to one of the following reasons:

- The baud rate specified was incorrect.
- The part did not start the monitor mode security check on reset. Signals to force monitor mode may be incorrect.

- No Power to the ICS.

If this status bit returns an 'N', you must correct this before analyzing the rest of the status bits.

- **2 – Device echoed all security bytes:**

To pass security, the software must send eight security bytes to the processor. The processor echoes each of these eight bytes twice. If all eight bytes do not get the proper two-byte echo, this flag returns an 'N'. Reasons for this include:

- The part did not start the monitor mode security check on reset. Signals to force monitor mode may be incorrect.
- The baud rate specified was incorrect.
- The processor was not reset properly. Check the Target Hardware Type and, if you are connecting to a class II board, check the MON08 cable communication connections type in the Advanced Settings dialog box.

- **3 – Device signaled monitor mode with a break:**

Once the processor has properly received the eight bytes from the PC software to complete its security check, it transmits a break character to the PC signaling entry into monitor mode. This break is sent regardless of whether the security check was successfully passed. If a break was not received from the processor, this flag returns an 'N'. Reasons for this include:

- The baud rate specified was incorrect.
- The processor was not reset properly. Check the Target Hardware Type. If you are connecting to a class II board, check the MON08 cable communication connections type in the Advanced Settings dialog box.

- **4 – Device entered monitor mode:**

Once the software has received, or failed to receive, a break from the processor, it attempts to communicate with the monitor running on the M68HC08 processor. It tries to read the monitor version number by issuing a monitor mode read. If the processor fails to respond properly to this command, this flag returns an 'N'.

- **5 – Reset was Power-On Reset:**

If the device properly entered monitor mode (4), the software reads the reset status register (RSR). This read does not affect the security sequence, and occurs purely for diagnostic reasons. The RSR indicates the conditions under which the processor underwent the last reset. For the software to pass the security check properly, it MUST first cause the processor to undergo a Power-On Reset. The software reads the RSR to determine if the last reset was indeed caused by power-on. The result of the RSR read is indicated in parentheses after the flag value. If the highest bit is not set then the reset was not a power on reset, and the flag indicates an 'N'. Reasons for this include:

HC08 P&E Multilink/Cyclone Pro Connection

Connection Procedure

- The processor did not power all the way down because power was being supplied to the processor through either the port pins, IRQ line, RESET line, or power pins.
 - The voltage driven on the power pin of the processor did not go below 0.1 volts.
 - The processor was not reset properly. Check the Target Hardware Type. If you are connecting to a class II board, check the MON08 cable communication connections type in the Advanced Settings dialog box.
- **6 – ROM is accessible (un-secured):**

If the device properly entered monitor mode (4), the software reads locations \$FFF6-\$FFFF to determine if the processor passes the security check. Memory locations which are invalid or protected read back from the device as \$AD. If all bytes from \$FFF6-\$FFFF read a value of \$AD, it is assumed the device is secure, and the flag value is an 'N'. If all flags 0-5 register a value of 'Y' and flag 6 registers a value of 'N,' then the reset process has occurred correctly except that the security code used to pass security was incorrect. Specify the correct security code and try again, or IGNORE the security failure and erase the device. Once you erase a secured device, you must exit the software and restart it in order to pass security.

Connection (MultilinkCyclonePro) Menu

Figure 14.12 MultilinkCyclonePro Menu

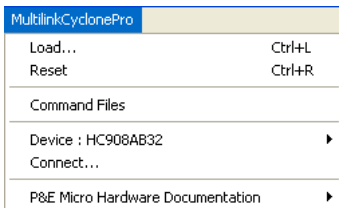

Device Option

The **Device** option in the MultilinkCyclonePro menu allows the user to select the particular Freescale processor that they wish to use. When choosing **Device** from the MultilinkCyclonePro menu, extended menus open that allow you to select the family (e.g. AB Family), and device type of the MCU that you are using.

Figure 14.13 HC08 Device Extended Menus

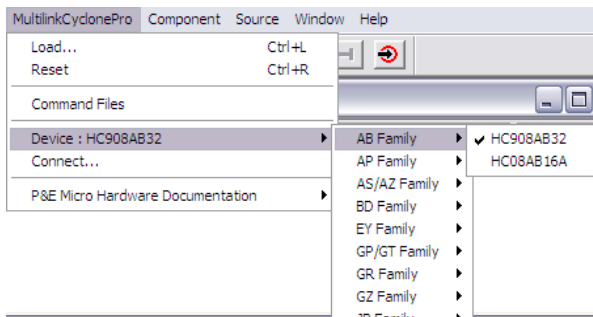

Connect Option

The **Connect** option initiates an attempt to communicate with the device chosen under the device section of the menu.

Active Mode Menu Options

When the microprocessor is connected, more Connection menu entries become available to the user.

Figure 14.14 Additional Menu Options



Advanced Programming/Debug Options

The Advanced Programming/Debug Options menu entry opens the Advanced Options dialog box, where you can configure software settings for the FLASH programming procedure.

Figure 14.15 Advanced Options Dialog Box

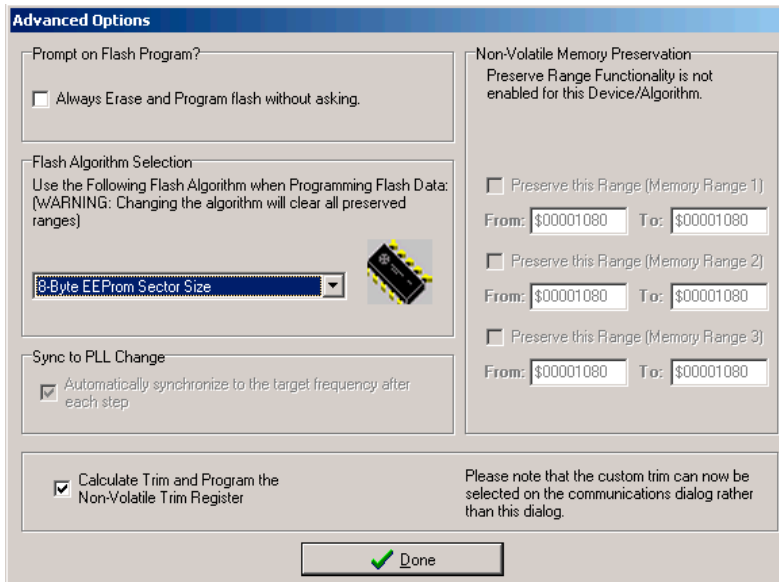

Prompt on Flash Program Checkbox

Checking **Always Erase and Program Flash without asking** lets the software transparently program the microprocessor.

Trim Options

The **Calculate Trim and Program the Non-Volatile Trim Register** checkbox enables automatic calculation and programming of the trim value in a designated Non-Volatile memory location.

Sync to PLL Change Checkbox

Sync to PLL Change is required for the software/hardware connection to synchronize with the microprocessor during the Flash erasing/programming procedure.

NOTE The Non-Volatile Memory Preservation and Custom Trim functionality are only available for the M68HCS08 devices, and as such these options are disabled for all M68HC08 devices.

Start Expert Mode Programmer Option

Start Expert Mode Programmer grants the user access to P&E's graphical Flash programming utility, PROG08SZ. PROG08SZ lets an advanced user control the step-by-step execution of the Flash erase/programming procedure. See [Figure 14.16](#). More information on how to use PROG08SZ can be found on P&E Microcomputer Systems website at: www.pemicro.com.

Figure 14.16 PROG08SZ Programmer Window

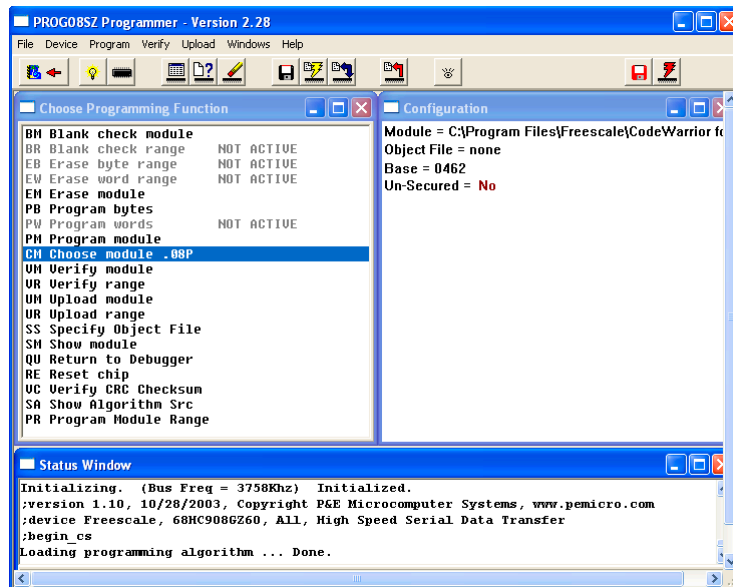

View Register Files Option

The *View Register Files* menu selection also gives the user the option of running the register file viewer/editor. If register files are available for the device that you have chosen, the **Choose a Register Block** window (see [Figure 14.17](#)) opens. You may also open it by entering the R command in the Command Window command line.

Figure 14.17 Choose A Register Block Window

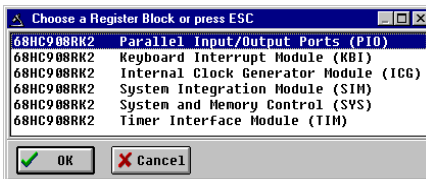

If register files have been installed on the host computer, selecting a block brings up the Register Block register listing (see [Figure 14.18](#)), which shows a list of the associated registers, their addresses, and their descriptions. This begins interactive setup of system registers such as I/O, timer, and COP watchdog.

Figure 14.18 Register Block Register Listing

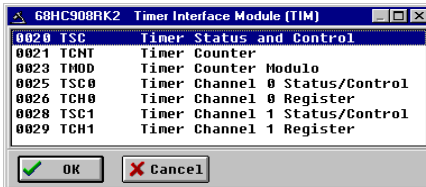

Selecting a file brings up the Register Window (see [Figure 14.19](#)), which displays the values and significance for each bit in the register. The registers can be viewed and their values modified, and the values can be stored back into debugger memory.

Figure 14.19 Register Window

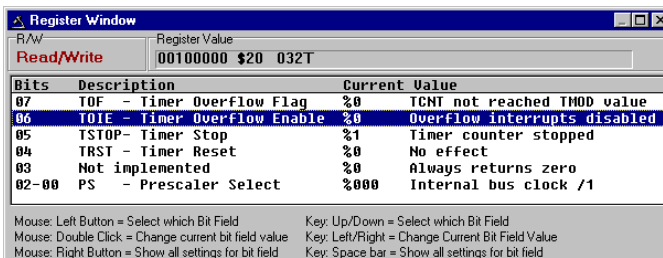

Debugging Limitations

The following limitations are inherent in MON08 debugging. Observe these restrictions carefully.

1. Do not step a command that branches to itself.
2. Do not step a software interrupt (SWI) command.
3. The hardware breakpoint registers are reserved for use by the debugger. Attempting to use these registers for other purposes may not work.
4. Be careful about showing peripheral status and data registers in the memory or variables window. A refresh of the window reads these registers and may cause the clearing of flags.
5. The debug monitor built into CPU08 processors uses up to 13 bytes of the stack. Do not write to these addresses from (SP-13) to SP. To load a program into RAM, move the stack to the end of RAM.
6. If interrupts are turned on during stepping, the debugger does not step into the interrupt. Instead, it executes the whole interrupt and stops on the command following the interrupt.
7. Do not set hardware breakpoints within the monitor ROM area itself. Hardware breakpoints set in this area do not function properly.

Debugging Tips

The following tips may prove useful:

1. Single stepping is allowed in both RAM or ROM.
2. The first breakpoint set is always a hardware breakpoint, and any additional breakpoints set are software breakpoints. To make sure that a hardware breakpoint is being set, make sure only one breakpoint is being used.
3. Hardware breakpoints can stop execution in ROM or RAM. Software breakpoints can stop execution only in RAM.
4. Experiment with the register interpreter. Use the *View Register Files* option in the MultilinkCyclonePro menu.
5. Executing an SWI instruction while running is functionally equivalent to hitting a breakpoint, except that execution stops at the instruction following the SWI.
6. A hardware breakpoint may be used to trap a data read/write to anywhere in the memory map. The debugger stops at the instruction after the one that accesses the data location.
7. When the target board is reset by the debugger, power to the microcontroller may be turned off for a short duration. Although much of RAM may look the same, some values may have changed.

Device Class Description

The following device information summarizes the different classes of boards available to the user. Detailed information about specific devices is available from Freescale.

Class 5 Device

P&E's MON08 Cyclone Device connects to a PC via the serial port. The Cyclone-to-MCU connection occurs via a standard 16-pin MON08 ribbon cable. The MON08 Cyclone Device allows the user to auto-detect the baud rate as well as auto-cycle the power through the MCU system.

Class 7 Device

P&E MON08 Multilink and USB MON08 Multilink cables connect to the user's MCU system via a standard 16-pin MON08 ribbon cable. MON08 Multilink and USB MON08 Multilink allow one to auto-detect the baud rate as well as auto-cycle the power through the microprocessor system.

Class 8 Device

P&E's Cyclone Pro communicates with the PC through a Serial, Ethernet or USB port. The Cyclone Pro can be used to debug and program the firmware inside of Freescale HC08 microprocessors via a standard 16-pin MON08 ribbon cable. The Cyclone Pro can provide its own power and clock signals to the microprocessor, as long as proper signals are connected to the corresponding pins of the 16-pin MON08 header. In addition the Cyclone Pro can be used for programming and debugging the HC08/HC12/HCS12 Freescale microprocessors via a standard 6-pin ribbon cable. To take advantage of this functionality, connect proper signals to the standard 6-pin Background Debug Module header.

HC08 ICS P&E Multilink/ Cyclone Pro Connections

In-Circuit Simulation (ICS) Mode is a P&E Microcomputer Systems mode of operation that is a hybrid between In-Circuit Debugging and Full Chip simulation. P&E has combined the benefits of each of these modes, while minimizing their respective deficiencies.

ICS mode simulates the CPU core instructions on the user's PC. However, Inputs/Outputs are read directly from the user's development device, and certain modules are run on the actual device. Any instructions that affect an I/O location, for example, `lda PORTA` or `sta PORTA`, also use data from the real device. This allows for all the benefits of full chip simulation (Cycle by Cycle accuracy, unlimited breakpoints, and speed, to name just a few), while allowing the obvious benefit of garnering relevant signals from actual hardware.

In-Circuit simulation requires a user to have a connected MCU Device, be it a development board, prototype hardware, or simply a device placed in a simple circuit on a breadboard. Once connection is established, the P&E Interface loads a `.MON` file to the microcontroller itself. This `.MON` file is the ICS-Kernel; it constantly runs on the device, and interacts with the P&E software to provide information about changing I/O and any peripherals that are running on the device itself.

The following modules are run on the actual device when in ICS mode, and as such their Simulation commands become unnecessary, and therefore do not function:

I/O ports, SCI, SPI, IRQ, ADC, LCD, KBI.

All other modules function as fully simulated modules. For information about relevant simulation commands, see the [HC08 Full Chip Simulation](#) section.

Connection Procedure

1. Choose the ICS P&E Multilink/Cyclone Pro option from the set connection dialog box, as shown in [Figure 15.1](#).

Figure 15.1 Set Connection Dialog Box

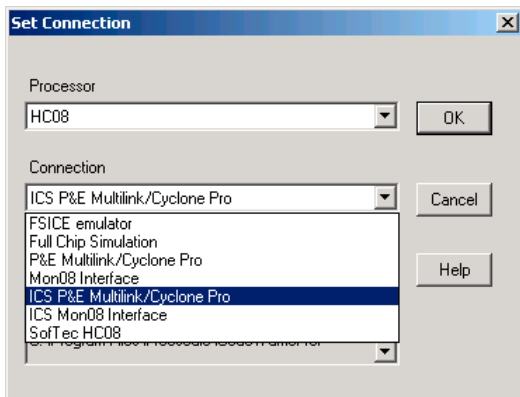

2. Click the *OK* button to bring up the P&E Connection Manager Window.

Figure 15.2 P&E Connection Manager Window - Connect to Target Tab

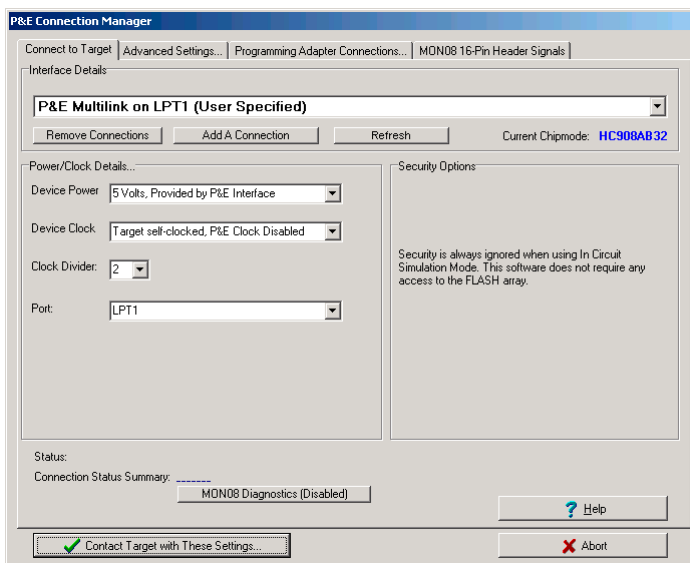

3. The device power selection in the Power/Clock Details area allows the user to specify whether the target is 2, 3, or 5 Volts, and whether this power is switched/generated by the P&E interface or if it is separately supplied to the target and under user control. If it is under user control, the software uses dialog boxes to prompt the user to power the target up and down when necessary (similar to Class II-IV). See [Figure 15.3](#).

Figure 15.3 Device Power Selection Box

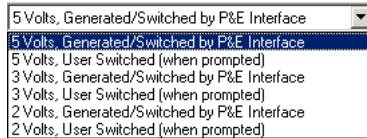

Figure 15.4 M68HC08 Device Clock Selection Box



4. The device clock menu allows two options. See [Figure 15.4](#).
 - P&E provides clock to target
 - The device has its own clock
5. Click on **Refresh**, which detects all P&E devices that are automatically detected, such as Cyclone Pro USB, Cyclone Pro Ethernet and USB ML MON08 Multilink. See [Figure 15.2](#).
6. To add a serial/parallel port P&E device such as Cyclone Pro Serial, MON08 Multilink and Cyclone Pro Ethernet (IP outside of subnet mask), proceed to Interface Selection Manager by pressing the **Add A Connection** button. For more information about configuring Cyclone Pro for ethernet operation, see the Cyclone Pro User's Manual.
7. To remove a manually configured interface, click on **Remove Connection** button and choose the interface to be deleted. See [Figure 15.5](#).

HC08 ICS P&E Multilink/Cyclone Pro Connections

Connection Procedure

Figure 15.5 Remove A Manually Configured Multilink/Cyclone Pro Interface

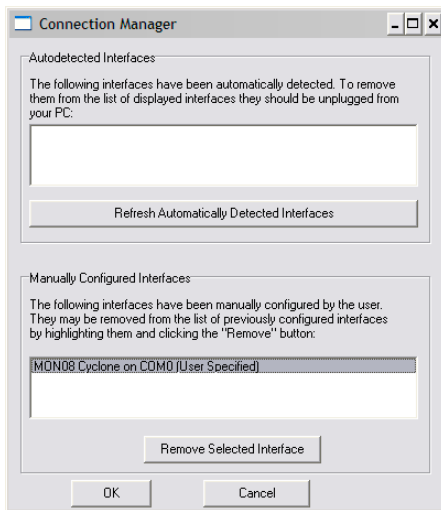

Advanced Settings Tab

The Advanced Settings tab of the P&E Connection Manager window allows the user to set specific protocol settings. The following is an explanation of the Advanced Settings tab.

Figure 15.6 P&E Connection Manager Window - Advanced Settings Tab

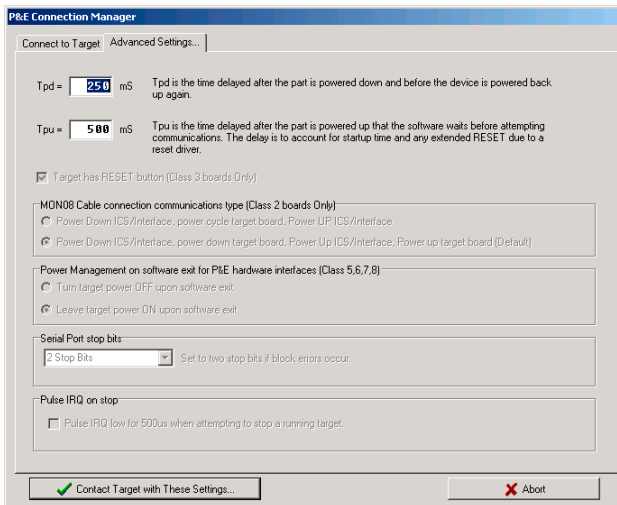

Tpu and Tpd Timing Textboxes

Tpu and Tpd set the power-up and power-down delay (respectively) that is observed when power-cycling a target for entry into Monitor Mode. These settings are only valid for devices with automatically controlled power.

Whenever power is automatically or manually switched off, the software waits for an amount of time equal to the Tpd delay time before proceeding to the connection protocol. This is because a board or power supply may have capacitance which holds the power up for a short time after the supply has been switched off, but the supply voltage must reach less than 0.1v before it is turned back on if a Power-On reset is to occur.

Whenever power is automatically or manually switched on, the software waits for an amount of time equal to the Tpu delay time before attempting to contact the M68HC08 processor. This is to allow time not only for power to be fully available, but to allow all reset drivers to release the RESET line.

Target has RESET Button

In using Class III boards, the software occasionally needs to get control of the target. For a more detailed description of device classes, see [Device Class Description](#). On systems which are Class III boards with the monitor mode circuitry built-in (including RS-232 driver), there is no means to reset the target to gain control. If the board has a reset button, the software can use this to gain control of the target system. If this option is checked, the software prompts the user to push the target reset button when a reset of the target system is desired. If the option is unchecked, the software prompts the user to power cycle the target system to achieve a reset.

MON08 Cable Connection Communications Type

This selection box is valid only for Class II hardware configurations using the MON08 cable. It allows the user to specify the sequence that the software uses to power up the ICS system. For a more detailed description of device classes, see [Device Class Description](#). When the software tries to create a power-on reset condition, two events must occur:

1. Power of the target MCU must go below 0.1v. This means that the processor cannot be receiving power from its power pins, nor can it have a significant voltage being driven on port pins or the IRQ line, as these drive the MCU power back through these pins. It is crucial, therefore, to have the ICS and the Target both powered down at some point in time.
2. The processor MON08 configuration pins, including IRQ, must be properly driven when the target processor resets to drive it into monitor mode. If these pins are not set up properly before the processor powers up, the processor may start up in user mode.

Power Up/Down Radio Buttons

Power Down ICS prompts the user to power down the board. **Power Up ICS** prompts the user to power up the board.

This is the default option and works for most, if not all, ICS08/Target Board solutions.

1. Software automatically powers down the ICS.
2. Software asks the user to power down the board as follows:

Figure 15.7 Power Down Dialog Box

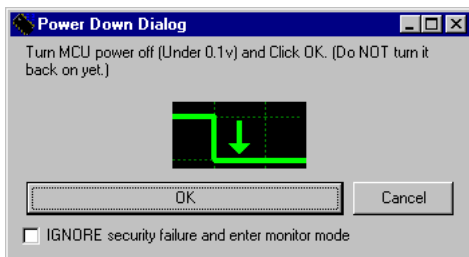

3. Software automatically powers up the ICS, which configures the processor's MON08 configuration pins.
4. Software prompts the user to power up the board as follows:

Figure 15.8 Power Up Dialog Box

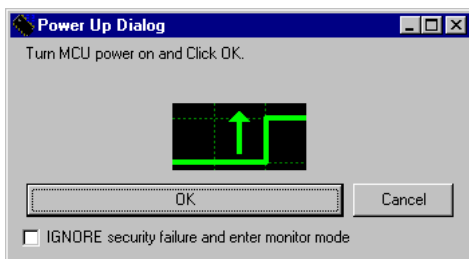

Cycle Power Up/Down Radio Buttons

Cycle Power ICS asks the user to power cycle the board.

This option works for many ICS boards as well, but relies on the fact that while the ICS is powered off, it holds the target in reset until it is powered up itself and has configured the MON08 configuration pins. The sequence of events in this mode is:

1. Software automatically powers down the ICS.
2. Software asks the user to power cycle their board as follows:

Figure 15.9 Power Cycle Dialog Box

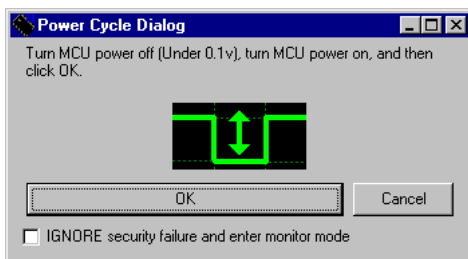

3. Software automatically powers up the ICS, which configures the processors MON08 configuration pins.

Target MCU Security Bytes

In ICS mode, the user's code is simulated on the PC, and not run from the Non-Volatile memory of the device. Therefore, there is no need to pass security in this mode of operation.

STATUS Area

The status area of the P&E Connection Manager window consists of one status string following the **Status:** label, and seven items which list the state of the last attempt to connect to a target and pass security. The description for these items is as follows:

- **0 – ICS Hardware loopback detected:**

Every ICS or board which supports MON08 has a serial loopback in hardware which, by connecting the transmit and receive lines, automatically echoes characters from the PC. A valid character transmitted from the PC is echoed once by the loopback circuitry on the board and once by the monitor of the target processor itself. This status indicates whether or not the first echoed character from the hardware loopback was received when one of the security bytes was transmitted. If the status is

HC08 ICS P&E Multilink/Cyclone Pro Connections

Connection Procedure

'N', which indicates that the character was not received, it is most likely due to one of the following reasons:

- Wrong Com Port specified.
- The baud rate specified was incorrect (probably too low).
- The ICS/Target is not connected.
- No Power to the ICS.

If this status bit returns an 'N', you must correct this before analyzing the rest of the status bits.

- **1 – Device echoed some security bytes:**

The monitor resident in an M68HC08 device automatically echoes every incoming character when it is in monitor mode. A valid character transmitted from the PC is echoed once by the loopback circuitry on the board and once by the monitor of the target processor itself. This status indicates whether or not the second echoed character from the monitor response was received when one of the security bytes was transmitted. If the status is 'N', which indicates that the character was not received, or not received properly, it is most likely due to one of the following reasons:

- The baud rate specified was incorrect.
- The part did not start the monitor mode security check on reset. Signals to force monitor mode may be incorrect.
- No Power to the ICS.

If this status bit returns an 'N', you must correct this before analyzing the rest of the status bits.

- **2 – Device echoed all security bytes:**

In order to pass security, the software must send eight security bytes to the processor. The processor echoes each of these eight bytes twice. If all eight bytes did not get the proper two-byte echo, this flag returns an 'N'. Reasons for this include:

- The part did not start the monitor mode security check on reset. Signals to force monitor mode may be incorrect.
- The baud rate specified was incorrect.
- The processor was not reset properly. Check the Target Hardware Type and if you are connecting to a class II board, check the MON08 cable communication connections type in the Advanced Settings dialog box.

- **3 – Device signaled monitor mode with a break:**

Once the processor has properly received the eight bytes from the PC software to complete its security check, it transmits a break character to the PC signaling entry into monitor mode. This break character is sent regardless of whether the security

check was successfully passed. If a break character is not received from the processor, this flag returns an 'N'. Reasons for this include:

- The baud rate specified was incorrect.
- The processor was not reset properly. Check the Target Hardware Type. If you are connecting to a class II board, check the MON08 cable communication connections type in the Advanced Settings dialog box.

- **4 – Device entered monitor mode:**

Once the software has received, or failed to receive, a break from the processor, it attempts to communicate with the monitor running on the M68HC08 processor. It tries to read the monitor version number by issuing a monitor mode read. If the processor fails to respond properly to this command, this flag returns an 'N'.

- **5 – Reset was Power-On Reset:**

If the device properly entered monitor mode (4), the software reads the reset status register (RSR). This read does not affect the security sequence, and occurs purely for diagnostic reasons. The RSR indicates the conditions under which the processor underwent the last reset. For the software to pass the security check properly, it **MUST** first cause the processor to undergo a Power-On Reset. The software reads the RSR to determine if the last reset was indeed caused by power-on. The result of the RSR read is indicated in parentheses after the flag value. If the highest bit is not set then the reset was not a power on reset, and the flag indicates an 'N'. Reasons for this include:

- The processor did not power all the way down because power was being supplied to the processor through either the port pins, IRQ line, RESET line, or power pins.
- The voltage driven on the power pin of the processor did not go below 0.1 volts.
- The processor was not reset properly. Check the Target Hardware Type. If you are connecting to a class II board, check the MON08 cable communication connections type in the Advanced Settings dialog box.

- **6 – ROM is accessible (un-secured):**

If the device properly entered monitor mode (4), the software reads locations \$FFF6-\$FFFF to determine if the processor passes the security check. Memory locations which are invalid or protected read back from the device as \$AD. If all bytes from \$FFF6-\$FFFF read a value of \$AD, it is assumed the device is secure, and the flag value is an 'N'. If all flags 0-5 register a value of 'Y' and flag 6 register a value of 'N,' then the reset process has gone correctly except that the security code used to pass security was incorrect. Specify the correct security code and try again, or IGNORE the security failure and erase the device. Once you erase a secured device, you must exit the software and restart it in order to pass security.

Active Mode Menu Options

When the microprocessor is connected, more Connection menu options become available to the user.

Figure 15.10 Additional Connection Menu Options

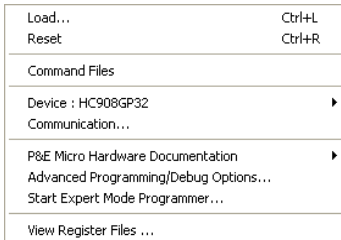

Advanced Programming/Debug Options

The Advanced Programming/Debug Options menu entry takes you to the Advanced Options dialog box, where you can configure the software settings for the Flash programming procedure.

Figure 15.11 Advanced Options Dialog Box

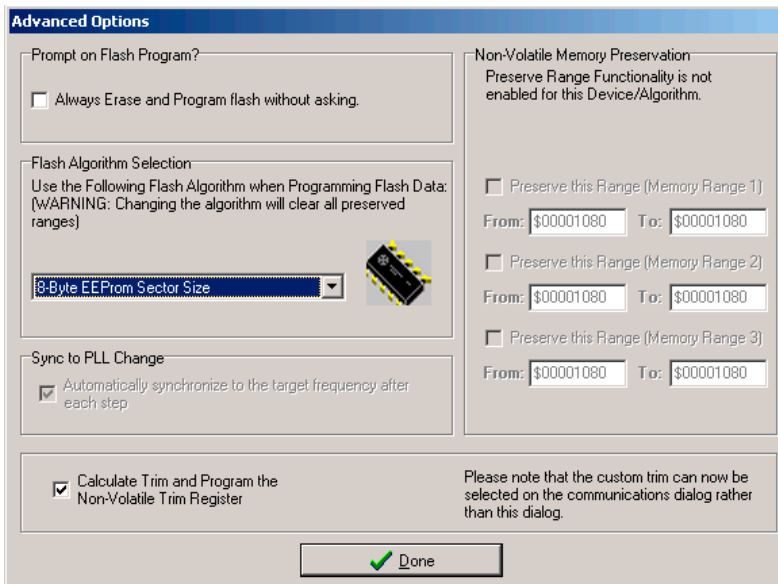

Prompt on Flash Program Checkbox

Checking **Always Erase and Program Flash without asking** in this dialog box lets the software transparently program the microprocessor.

Trim Options

The **Calculate Trim and Program the Non-Volatile Trim Register** checkbox enables automatic calculation and programming of the trim value in a designated Non-Volatile memory location.

Sync to PLL Change Checkbox

Sync to PLL Change is required for the software/hardware connection to synchronize with the microprocessor during the Flash erasing/programming procedure.

NOTE The Non-Volatile Memory Preservation and Custom Trim functionality are only available for the M68HCS08 devices, and as such these options are disabled for all M68HC08 devices.

Start Expert Mode Programmer Option

Start Expert Mode Programmer grants the user access to P&E's graphical Flash programming utility, PROG08SZ. PROG08SZ lets an advanced user control the step-by-step execution of the Flash erase/programming procedure. See [Figure 15.12](#). For more information on using PROG08SZ, access P&E Microcomputer Systems website at: www.pemicro.com.

HC08 ICS P&E Multilink/Cyclone Pro Connections

Connection Procedure

Figure 15.12 PROG08SZ Programmer Window

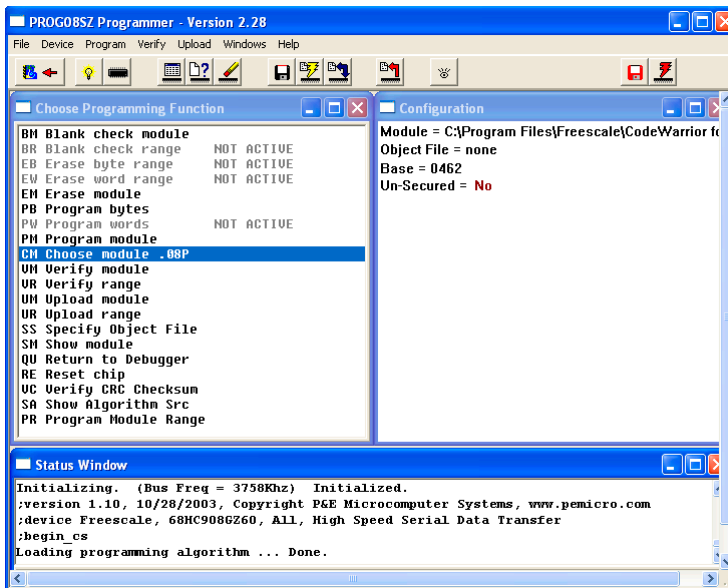

View Register Files Option

The *View Register Files* menu selection also gives the user the option of running the register file viewer/editor. If register files are available for the device that you have chosen, the Choose a Register Block window (see [Figure 15.13](#)) opens. You may also open it by entering the R command in the Command Window command line.

Figure 15.13 Choose A Register Block Window

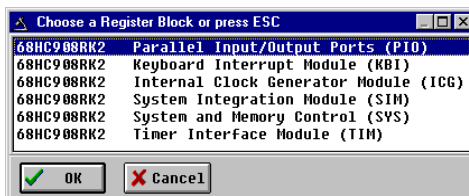

If register files have been installed on the host computer, selecting a block brings up the Register Block register listing (see [Figure 15.14](#)), which shows a list of the associated registers, their addresses, and their descriptions. This begins interactive setup of system registers such as I/O, timer, and COP watchdog.

Figure 15.14 Timer Interface Module Register Listing

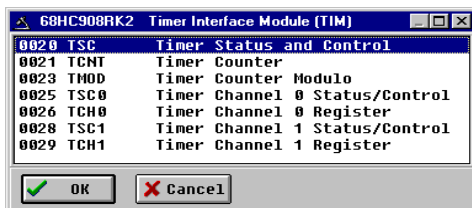

Selecting a file brings up the Register Window (see [Figure 15.15](#)), which displays the values and significance for each bit in the register. The registers can be viewed and their values modified, and the values can be stored back into debugger memory.

Figure 15.15 Register Window

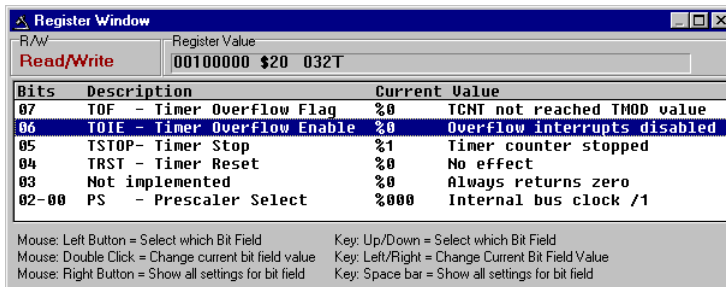

Device Class Description

The following device information summarizes the different classes of boards available to the user. Detailed information about specific devices is available from Freescale.

Class 5 Device

P&E MON08 Cyclone Device connects to PC via a serial port. The Cyclone to target connection takes place via a standard 16 pin MON08 ribbon cable. MON08 Cyclone Device allows one to auto detect the baud rate as well as auto cycle the power through the target.

Class 7 Device

P&E MON08 Multilink and USB MON08 Multilink cables connect to the target via a standard 16 pin MON08 ribbon cable. MON08 Multilink and USB MON08 Multilink allow one to auto detect the baud rate as well as auto cycle the power through the target.

HC08 ICS P&E Multilink/Cyclone Pro Connections

Device Class Description

Class 8 Device

P&E's Cyclone Pro communicates with the PC through a Serial, Ethernet or USB port.

One can use the Cyclone Pro to debug and program the firmware inside of Freescale M68HC08 microprocessors via a standard 16-pin MON08 ribbon cable. The Cyclone Pro can provide its own power and clock signals to the target, as long as proper signals are connected to the corresponding pins of the 16-pin MON08 header.

In addition, the Cyclone Pro can be used for programming and debugging the M68HC12/M68HCS12/M68HCS08 Freescale microprocessors via a standard 6-pin ribbon cable. To take advantage of this functionality, connect proper signals to the standard 6-pin Background Debug Module header.

SofTec HC08 Connection

This section guides you through the first steps toward debugging with the CodeWarrior IDE and the *SofTec HC08* connection. It does not replace all the additional documentation provided in this manual, but gives you a good starting point.

SofTec HC08 Technical Considerations

The 8/16 bits debugger (and then the CodeWarrior IDE) might be connected to HC08 hardware using the SofTec HC08.

When the debugger runs the **SofTec HC08** connection, it can communicate and debug HC08-based hardware connected through the SofTec in-circuit debugger/programmer units, such as the SofTec Microsystems HC08 ISP Debuggers/Programmers (inDART Series) and Starter Kits (AK/SK/PK/ZK and newer Series).

Refer to the *inDART®-HC08 In-Circuit Debugger/Programmer for Motorola HC08 Family FLASH Devices User's Manual* from SofTec for communication hardware requirements and SofTec product installation.

CodeWarrior IDE and SofTec HC08 Connection

There are two separate paths that may be followed to take the first steps toward debugging with the CodeWarrior IDE and the SofTec inDART-HC08 connection. The differences between the two paths hinge on the starting point for the steps:

- Using the Stationary Wizard at the start of the project
- From within an existing project

Using the Stationery Wizard

To take the first steps toward debugging with the CodeWarrior IDE and the SofTec inDART-HC08 using the stationery Wizard:

1. Run the CodeWarrior IDE with the shortcut created in the program group.
2. Choose the menu *File > New* to create a new project from a stationery - the **HC08 New Project Wizard first** screen appears.
3. In the list box on the left of the screen, select the HC08 MCU you are targeting.
4. In the Connections list box, select **SofTec HC08** as the connection.

Figure 16.1 Wizard Connection Selection

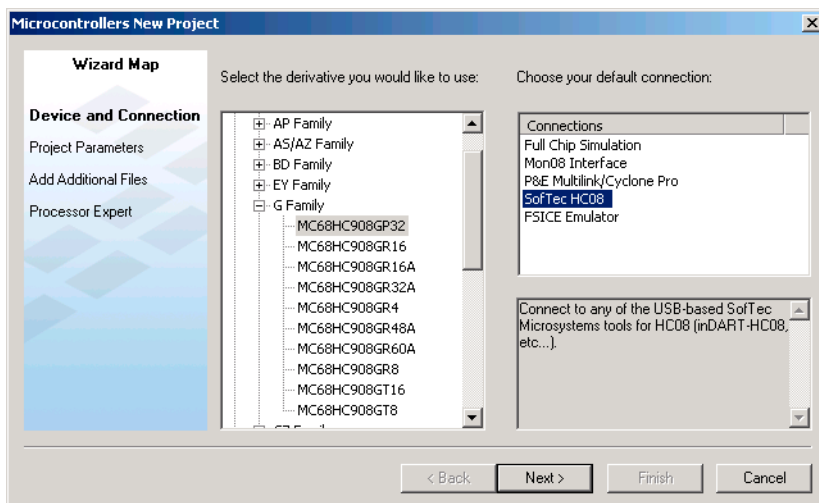

5. Finish the Wizard steps - the IDE opens.
6. In the IDE main window toolbar Project menu, choose *Project > Make*.
7. Now choose *Project > Debug* to start the debugger.

From Within an Existing Project

To take the first steps toward debugging with the CodeWarrior IDE and setting the SofTec HC08 connection from within an existing debugging project:

1. Run the CodeWarrior IDE.
2. Open the project.
3. Choose *Project > Debug* to start the debugger.
4. In the Debugger, choose *Component > Set Connection* to select another target interface in the Set Connection dialog box.
5. Select **HC08** as Processor.
6. Select **SofTec HC08** as connection.

Figure 16.2 Set Connection Dialog Box - SofTec HC08 Selection

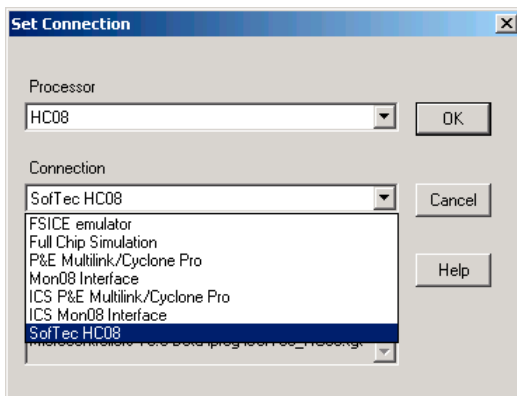

7. In the MCU Configuration dialog box, choose the correct target processor.

SofTec HC08 Connection

From Within an Existing Project

Figure 16.3 MCU Configuration Dialog Box

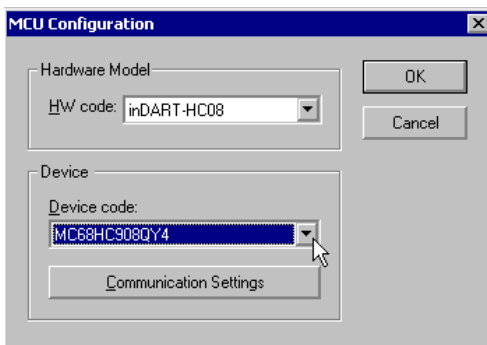

8. Press the OK button to start debugging.

inDart-HC08 Menu Options

Once the *SofTec HC08* connection is set, the connection menu entry in the debugger main toolbar is *inDART-HC08*.

Figure 16.4 inDART-HC08 Menu Options

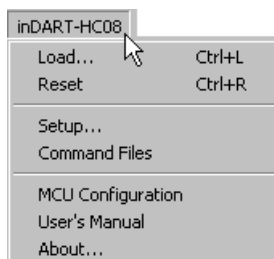

MCU Configuration Option

Select the *inDART-HC08 > MCU Configuration* option to display the [MCU Configuration Dialog Box](#).

User's Manual Option

Select the *inDART-HC08 > User's Manual* option to open the *inDART®-HC08 In-Circuit Debugger/Programmer for Freescale HC08 Family FLASH Devices User's Manual* from SofTec.

About Option

Select the *inDART-HC08* > *About* option to display the [About Dialog Box](#).

MCU Configuration Dialog Box

You can expand the *Hardware Model* list menu to select another type of debug interface than the SofTec inDART-HC08. You can expand the *Device Code* list menu to select another HC08 derivative.

Figure 16.5 MCU Configuration Dialog Box

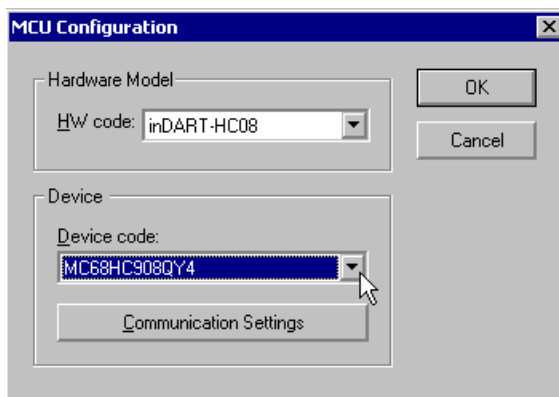

Pressing the *Communication Settings* button opens the [Communication Settings Dialog Box](#).

Communication Settings Dialog Box

Pressing the *Communication Settings* button in the MCU Configuration dialog box opens the Communication Settings dialog box, which allows you to fine-tune critical parameters needed for proper operation with the chosen target microcontroller.

The dialog box is divided into three sections: *Communication Parameters*, *MON08 Settings* and *Power Supply Parameters*. All of the parameters must be carefully set to ensure successful operation.

Refer to the *inDART®-HC08 In-Circuit Debugger/Programmer for Freescale HC08 Family FLASH Devices User's Manual* from SofTec for further details.

SofTec HC08 Connection

From Within an Existing Project

Figure 16.6 Communication Settings Dialog Box

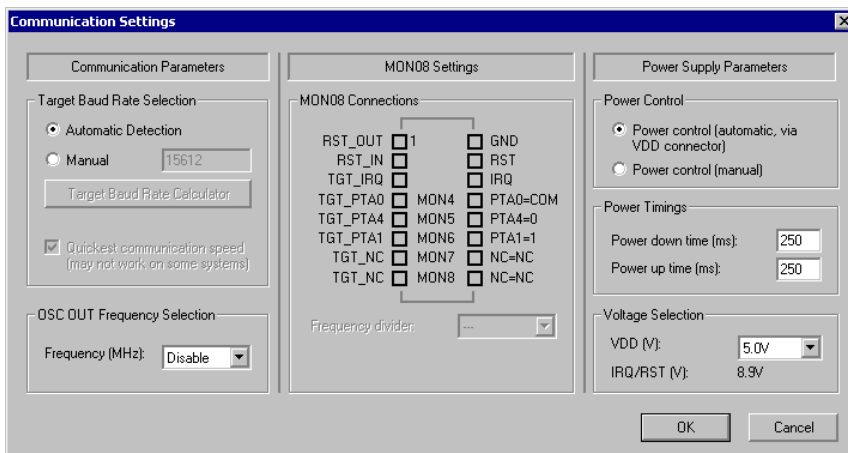

NOTE If your hardware supports stopping the application while running, an additional interrupt service routine is required for the IRQ vector. See **Stop Command Handling** section in *inDART®-HC08 In-Circuit Debugger/Programmer for Motorola HC08 Family FLASH Devices User's Manual* from SofTec for further details.

About Dialog Box

This dialog box belongs to the SofTec GDI DLL and provides information about the `inDART_HC08.dll` release and version.

Figure 16.7 About Dialog Box



HC08 FSICEBASE Emulator

This chapter is intended for developers, testers, application engineers, and anyone interested in using the Freescale In-Circuit Emulator Base (FSICEBASE) development system.

This chapter contains information about how to use the FSICEBASE tool that helps you develop applications for embedded systems based on a Freescale M68HC08 microcontroller unit (MCU).

NOTE The Freescale In-Circuit Emulator Base (FSICEBASE) is similar to a system called the MMDS0508, a Modular Development System (MMDS). If you have worked with the MMDS0508, many of the features of the FSICEBASE will be familiar to you.

FSICEBASE Overview

This overview section contains the following topics:

- [System Requirements](#)
- [System Features](#)
- [System Components](#)

The CodeWarrior IDE software provides an integrated development environment that includes an editor, assembler, and a user interface to the FSICEBASE system.

The environment allows you to perform source-level debugging. The CodeWarrior IDE software also simplifies the process of managing and building a software project, and debugging code for an embedded MCU system. The benefit to you is reduced development time.

System Requirements

The FSICEBASE system requires a host computer with the following minimum specifications:

- Processor: 200 MHz Pentium® II processor or AMD-K6® class processor
- Operating System: Microsoft® Windows® 2000, Windows® XP, or Windows Vista™
- RAM: 128 MB
- Hard drive space: Compact software installation: 232 MB
Full software installation: 344 MB
- USB port or Ethernet port to connect host computer to the FSICEBASE

System Features

The Freescale In-Circuit Emulator Base (FSICEBASE) is a full-featured development system that provides in-circuit emulation. Features include:

- Real-time, non-intrusive, in-circuit emulation
- Real-time bus state analysis
- Meets ECC92 European electromagnetic compatibility standards
- Allows you to set four complex data or instruction breakpoints; a breakpoint can be qualified by an address, an address range, data, or externally connected logic clips.
- Up to 128k real-time variables (any ROM or RAM memory area)
- Up to 128 Kilobytes of emulation memory to accommodate the largest available ROM size of current HC08 MCU
- Unlimited hardware instruction breakpoints over the 64-K memory map
- Built-in bus state analyzer:
 - 1.33Mb x 96 real-time trace buffer
 - Four hardware triggers to control real-time bus analysis and provide breakpoints
 - Nine triggering modes
 - Display of real-time trace data as raw data, disassembled instructions, raw data and disassembled instructions, or assembly-language source code
 - As many as 1.33M pre- or post-trigger points
 - Trace buffer can be filled while single-stepping through user software
 - 32-bit time tag
 - Custom clock from 4100Hz to 40MHz in 5kHz steps, permitting wide time variance between analyzer events

- 24 general-purpose logic clips, five of which can be used to trigger the bus state analyzer sequencer
- Four software-selectable internally generated oscillator clock sources
- Command and response logging to disk files
- Assembly-language source-level debugging
- On-screen, context-sensitive help via pop-up menus and windows
- Emulation that allows multiple types of reset

System Components

The FSICEBASE system includes the basic components that you need to connect to an emulation module (EM). You can also separately purchase additional components that can enhance debugging and emulation.

Basic Components

The Freescale In-Circuit Emulator Base includes the following components

- Base station
 - The connectors on the top of the box let you connect an emulation module (EM).
- Cables, connectors, and adapters:
 - crossover ethernet cable (connects directly to an Ethernet Network Interface Card (NIC) on a PC)
 - straight-through ethernet cable (connects to a hub or switch)
 - Universal Serial Bus (USB) cable
 - MON08 debug port (built into base station)
 - external universal power supply and power supply cable
- System software
 - CodeWarrior IDE software, featuring an editor, assembler, and assembly source level debugger
- Documentation:
 - Freescale In-Circuit Emulator Base User Manual (this manual)
 - CodeWarrior IDE User's Manual
 - Freescale In-Circuit Emulator Base Quick Start
 - Online Help and PDFs
- Two logic clip cable assemblies: twisted-pair cables that connect the station module to your target system. You can also use the cable assembly to connect a test fixture, a

clock, an oscillator, or any other circuitry that you might use to perform analysis. One end of each cable assembly has a molded connector, which fits into the FSICEBASE. Leads at the other end of each cable terminate in female probe tips. Ball clips come with the cables.

Additional Components

You can purchase other components to enhance your development efforts. You can purchase these components separately:

- Host computer

You must provide an IBM-compatible personal computer to run the development software.

- An emulation module (EM)

An emulation module (EM) is a printed circuit board that emulates the features of a specific set of microcontroller units (MCUs). An EM completes the functionality of the FSICEBASE for a particular MCU or MCU family. The FSICEBASE works with a variety of EMs. You can purchase EMs separately from the FSICEBASE.

The two DIN connectors on the bottom of the EM fit into connectors on the top of the FSICEBASE box. The target provides power and signal targets.

Connection to your target system is then made through a separately purchased target cable and target head adapter that attaches to a target connector located on the top of the EM board.

- Optional target cable

You can separately purchase a target cable that is part of a cable assembly, which is used to connect a target system to the FSICEBASE.

- Optional target head adapter

You can separately purchase a target head adapter that is part of a cable assembly, which is used to connect a target system to the FSICEBASE.

- Optional Bus State Analyzer (BSA) cables

The base station contains ports for three BSA pods. You can purchase BSA cables in addition to those supplied with the FSICEBASE system.

Setting Up the FSICEBASE System

The Freescale In-Circuit Emulator Base (FSICEBASE) development system includes cables and software. You need to connect the cables and install the software in order to use the FSICEBASE. This section contains the following topics to help you set up the system:

- [Setting Up the Hardware](#)
- [Establishing Communication](#)

Setting Up the Hardware

This section explains how to connect a host computer to the Freescale In-Circuit Emulator Base (FSICEBASE). There are three ways to connect a host computer to the FSICEBASE:

- Directly from the USB port of a host computer to the FSICEBASE USB port
- Directly from the ethernet port of a host computer to the FSICEBASE ethernet port
- From the host computer, through a Local Area Network (LAN), to the FSICEBASE ethernet port

Connect the FSICEBASE to a host computer in one of the three ways described in the following paragraphs.

1. If you are using an ethernet connection to connect your host computer to the FSICEBASE through a Local Area Network (LAN):
 - a. Connect host computer to LAN
 - b. Connect FSICEBASE to LAN
 - c. Make sure power supply is not connected to board
 - d. Connect one end of ethernet cable to ethernet port of FSICEBASE (make sure to use the straight-through ethernet cable when connecting to LAN)
 - e. Connect other end of ethernet cable to Local Area Network (LAN)

NOTE To complete the connection through a LAN, obtain the IP address, subnet mask, and default gateway information from your network administrator. This information is used in a later step.

2. If you are using an ethernet connection to connect your host computer directly to the FSICEBASE (not through a LAN):
 - a. Make sure power supply is not connected to board
 - b. Connect one end of ethernet cable to ethernet port of FSICEBASE (make sure to use the cross-over ethernet cable when connecting directly to a Network Interface Card (NIC))

HC08 FSICEBASE Emulator

Setting Up the FSICEBASE System

- c. Connect other end of USB cable to host computer

NOTE The host computer (PC) must have an assigned IP address and subnet mask that matches the FSICEBASE.

3. If you are using a USB connection to connect your host computer directly to the FSICEBASE:
 - a. Make sure power supply is not connected to board
 - b. Connect U-shaped end of USB cable to FSICEBASE
 - c. Connect other end of USB cable to host computer

Once you have connected the host computer to the FSICEBASE, connect Power supply to FSICEBASE

1. Connect round end of 5-volt power cord to barrel connector on FSICEBASE
2. Plug power supply into surge-protected strip
3. Connect surge-protected strip to AC outlet
4. Switch FSICEBASE Power switch to ON

LED lights after the base station finishes boot sequence.

There are three status LEDs on the box: busy, ready, and error. The FSICEBASE base station takes about 5 seconds to boot. After powering the unit, you must wait for the ready LED before attempting to connect.

The FSICEBASE is now ready to accept communication with a host computer. Install the CodeWarrior IDE software, create a project, and start the debugger to establish communication between your host computer and the FSICEBASE.

Establishing Communication

The Freescale In-Circuit Emulator Base (FSICEBASE) allows you to connect to a host computer in two ways:

- Through an ethernet port
- Through a USB port

Communication Through Ethernet Port

If you use an Ethernet connection to establish communication between your host computer and the FSICEBASE through a LAN, you need to do three things:

- Have network administrator assign IP address on LAN to the FSICEBASE
- Set IP address on FSICEBASE
- Specify IP address in the debugger

The following procedures explains how to do these things step by step.

To establish communication through a LAN:

1. Set up hardware as explained in [Setting Up the Hardware](#).
2. Obtain the IP address that your network administrator assigned to the FSICEBASE
3. Start the debugger as explained in [Starting the Debugger](#).
4. Make sure connection is FSICEBASE
 - a. From debugger main menu, select **Component**
 - b. Select **Set Connection** — Set Connection dialog box appears
 - c. Select **FSICEBASE emulator** from connection drop-down box
 - d. Click **OK** — the debugger adds the FSICEBASE-HC08 menu to the main menu bar
5. From debugger main menu, select **FSICEBASE-HC08**
6. Select **Communication**— Communication dialog box appears ([Figure 17.1](#))

HC08 FSICEBASE Emulator

Establishing Communication

Figure 17.1 Communication Dialog Box

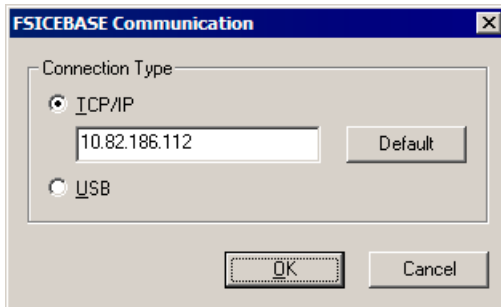

7. Select **TCP/IP**
8. In the text box, type the IP Address that your network administrator assigned to the FSICEBASE

NOTE For more information on the IP address of the FSICEBASE, see [“Assigning an IP Address to FSICEBASE”](#).

9. Click **OK**
The debugger connects to the FSICEBASE through the ethernet port.

Communication Through USB Port

If you use a USB connection to establish communication between your host computer and the FSICEBASE:

1. Set up hardware as explained in [Setting Up the Hardware](#).
2. Start the debugger as explained in [Starting the Debugger](#).

NOTE If you have started the debugger from your project previously, when you select Debug in the IDE, the Debugger attempts to connect to the FSICE with the last known settings. If the Debugger connects, you do not need to perform the following steps.

3. Make sure connection is FSICEBASE
 - a. From debugger main menu, select **Component**
 - b. Select **Set Connection** — Set Connection dialog box appears
 - c. Select **FSICE emulator** from Connection drop-down box
 - d. Click **OK**

4. From debugger main menu, select **FSICEBASE-HC08**
5. Select **Communication**— Communication dialog box appears ([Figure 17.1](#))
6. Select **USB**
7. Click **OK**

The debugger connects to the FSICEBASE through the USB port.

Setting Up the System

In order to use the Freescale In-Circuit Emulator Base (FSICEBASE), you need to make sure that the system is configured properly. Configuring the FSICE system includes:

- [Specifying A Connection](#)
- [Specifying Communication Information](#)
- [Assigning an IP Address to FSICEBASE](#)
- [Specifying a Memory Map](#)
- [Specifying the Clock Speed](#)

Specifying A Connection

To specify the connection, including the specific derivative:

1. Start the debugger — the **True-time Simulator & Real-time Debugger** window appears.
2. From debugger main menu, select **Component**
3. Select **Set Connection** from the Component menu — Set Connection dialog box opens

Figure 17.2 Set Connection Dialog Box

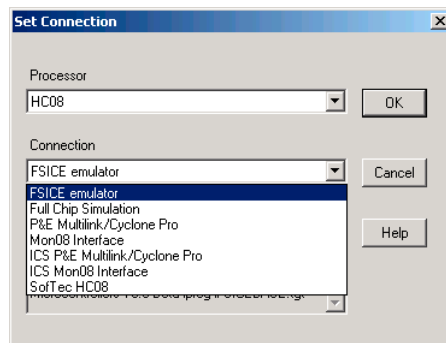

HC08 FSICEBASE Emulator

Setting Up the System

4. Select appropriate processor from **Processor** drop-down menu
5. Select appropriate **connection**. To specify the FSICEBASE as the connection, select **FSICE emulator**.
6. Click **OK** — The debugger configures itself to work with the connection that you specified.

Notice that the main menu of the debugger reflects your selection. The menu item between the **Run** menu and the **Component** menu shows the name of the connection that you selected. For example, if you selected FSICE emulator as the connection, the main menu contains a menu item labeled **FSICEBASE-HC08** as shown in [Figure 17.3](#). The FSICEBASE-HC08 list menu is also shown.

Figure 17.3 FSICEBASE Menu

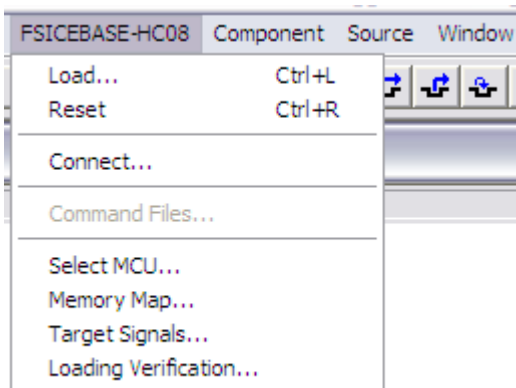

Specifying Communication Information

When you start the debugger from the CodeWarrior IDE, the debugger automatically prompts you to specify communication information. However, if necessary, you can change the communication information directly from the debugger.

To specify communication information:

1. Start the debugger — the **True-time Simulator & Real-time Debugger** window appears.
2. From debugger main menu, select **FSICEBASE-HC08**

The FSICEBASE-HC08 menu is between the Run menu and the Component menu. If you do not see the FSICEBASE-HC08 menu, you need to specify the connection. For more information on specifying a connection see [Specifying A Connection](#).

3. Select **Communication** — The FSICE Communication dialog box opens ([Figure 17.1](#))
4. Specify communication information
 - a. If you use an ethernet connection to connect your host computer to the FSICEBASE through a LAN:
 - Select **TCP/IP**, and
 - Type the IP address of the FSICEBASE in the text box.

NOTE The network administrator of your Local Area Network (LAN) needs to assign the IP address of the FSICEBASE on the network. You can use the default IP address, and give this address to your network administrator. Or, your network administrator might choose to create a different IP address. If the network administrator chooses the IP address, you need to assign the IP address to the FSICEBASE. For more information see [Assigning an IP Address to FSICEBASE](#).

- b. If you use an ethernet connection to connect your host computer directly to the FSICEBASE (not through a LAN):
 - In the Communication dialog box, select **TCP/IP**, and
 - In the text box of the Communication dialog box, type the IP address of the FSICEBASE

NOTE Make sure that the cable between the host computer and the FSICEBASE is a cross-over ethernet cable.

NOTE Make sure that the host computer uses a static IP address. (The FSICEBASE does not assign an IP address to the host computer.) If you use the default IP address of the FSICEBASE (192.168.0.1), we recommend that you assign the following IP address to the host computer: 192.168.0.2.

NOTE Make sure that the host computer and FSICEBASE both use the same subnet mask.

- c. If you use a USB cable to connect your host computer directly to the FSICEBASE station, select **USB**,
5. Click **OK**

The debugger attempts to connect to the FSICEBASE. An information box shows the progress. You can click **Cancel** in the information box if you do not want to immediately connect to the FSICEBASE.

The debugger saves the communication information that you specified. It uses the communication information the next time that it connects to the FSICEBASE.

Assigning an IP Address to FSICEBASE

The FSICEBASE ships from the factory with the following internal default IP address:

192.168.0.1

Depending on how you connect the host computer to the FSICEBASE, you might need to change the IP address of the FSICEBASE. The CodeWarrior IDE software includes a utility that allows you to assign a different IP address to the FSICEBASE.

To assign an IP address to the FSICEBASE:

1. Use a USB cable to connect the host computer to the FSICEBASE
2. Start the FSICEBASE Configuration Utility
 - a. From Windows desktop, click **Start** menu
 - b. Select **Run**
 - c. Browse to the following executable file:
`installation_directory\prog\GDI\FSICEBASE\setup.exe`
The `installation_directory` is the directory where you installed the CodeWarrior IDE software. The default installation directory is
`C:\Program Files\Freescale\CodeWarrior for
Microcontrollers V6.1\`
 - d. Click **OK** — The **FSICEBASE Configuration Utility** starts ([Figure 17.4](#))

Figure 17.4 FSICEBASE Configuration Utility Window

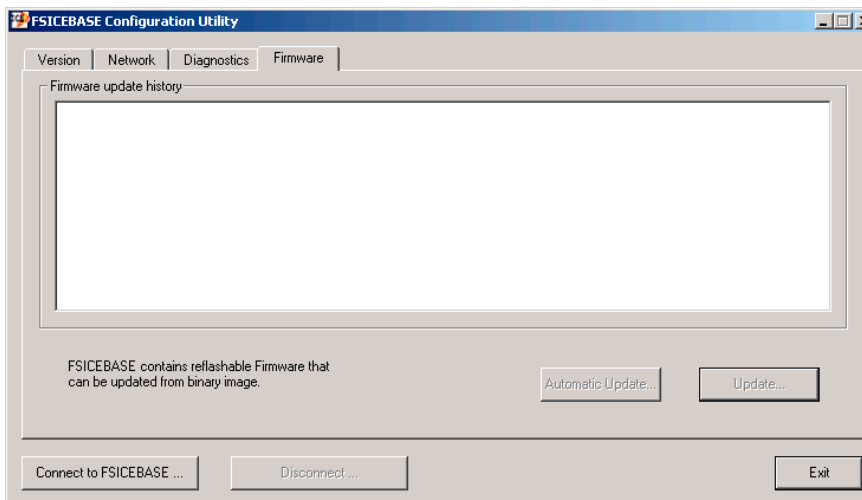

3. Click **Connect to FSICEBASE** button — **FSICEBASE Communication** dialog box appears, as shown in [Figure 17.1](#).
4. Select **USB**

NOTE You can also use the default IP address to connect through TCP/IP.

5. Click **OK** — the FSICEBASE Configuration Utility connects to the FSICEBASE
6. Click **Network** tab of FSICEBASE Configuration Utility
7. In **Address** text box, type the IP address that you want to assign to the FSICEBASE.

NOTE All hosts on a network must have a unique IP address. If you are connecting the FSICEBASE to a Local Area Network (LAN), consult with your network administrator to obtain a valid IP address.

8. From **Mask** combo box, select the subnet mask that you want to assign to the FSICEBASE

NOTE All the hosts in a sub-network must have the same subnet mask. For that reason, if you connect the host computer directly to the FSICEBASE (not through a LAN), you must ensure that the host computer uses the same subnet mask as the FSICEBASE.

HC08 FSICEBASE Emulator

Specifying a Memory Map

9. If applicable, in **Default Gateway** text box, type the IP address that you want the FSICEBASE to use as the gateway to connect to a network.
10. If applicable, in **Broadcast Address** text box, type the IP address that you want the FSICEBASE to use as the broadcast address on the network

NOTE The broadcast IP address is the last IP address in the range of IP addresses on a network. The broadcast address is reserved by the network to allow a single host to make an announcement to all hosts on the network. Consult your network administrator for more information.

11. Click **Change** button

The FSICEBASE Configuration Utility displays the IP Address Change Confirmation dialog box (Figure 17.5) with the information that you specified. If information is wrong, click **No** to return to the Network tab and correct the information.

Figure 17.5 IP Address Change Confirmation Dialog Box

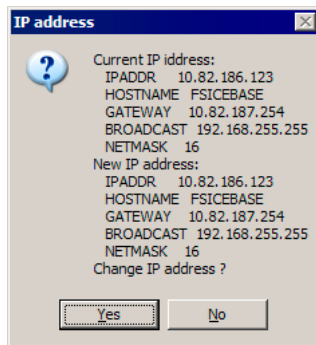

12. Click **Yes**

The FSICEBASE Configuration Utility assigns the new IP information to the FSICEBASE.

Specifying a Memory Map

Different MCU designs require different memory map configurations of the FSICEBASE system.

A personality file defines memory maps for particular MCUs. The personality file defines the memory map of each MCU supported by an emulator module (EM). Personality files ship with the separately purchased EMs. Refer to the appropriate EM user's manual to determine the personality files used by a particular EM module.

If an EM is connected to the FSICEBASE, the CodeWarrior IDE software automatically loads the default personality file that corresponds to the EM. If the CodeWarrior IDE software does not find an appropriate personality file, the debugger displays an error message when it tries to connect to the FSICEBASE.

After the debugger has loaded a memory map, you can view the memory map and modify it.

To use the Command line to view the current memory map:

1. From debugger main menu, select *Window > Command* to view the Command window. If you do not see the Command window:
 - a. From the debugger main menu select *Component > Open*
 - b. Select *Command*
 - c. Click *OK* — the debugger opens a new Command window.
2. Click on command line (place insertion point on command line)
3. Type MEM

Command window ([Figure 17.6](#)) displays memory map information: a representation of the current system memory map, and the lower and upper boundaries of the internal module that contains the MCU registers.

Figure 17.6 Command Window in the Debugger

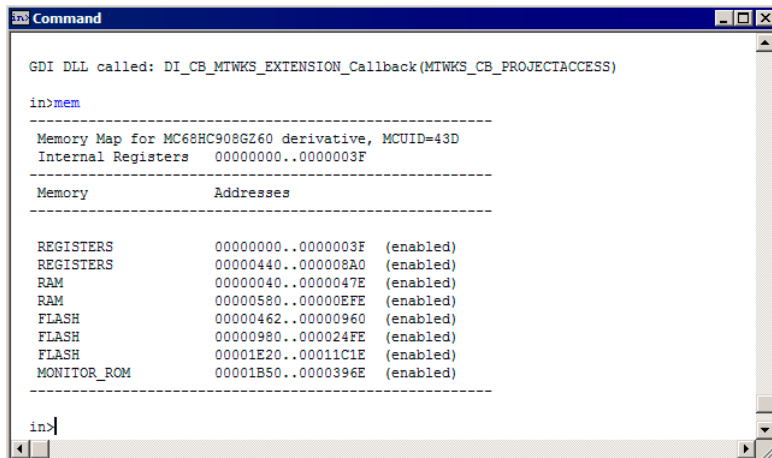

```

Command
-----
GDI DLL called: DI_CB_MTWKS_EXTENSION_Callback(MTWKS_CB_PROJECTACCESS)

in>mem
-----
Memory Map for MC68HC908G260 derivative, MCUID=43D
Internal Registers  00000000..0000003F
-----
Memory              Addresses
-----
REGISTERS           00000000..0000003F (enabled)
REGISTERS           00000440..000008A0 (enabled)
RAM                 00000040..0000047E (enabled)
RAM                 00000580..00000EFE (enabled)
FLASH               00000462..00000960 (enabled)
FLASH               00000980..000024FE (enabled)
FLASH               00001E20..00011C1E (enabled)
MONITOR_ROM        00001B50..0000396E (enabled)
-----
in>|
  
```

HC08 FSICEBASE Emulator

Specifying a Memory Map

To Modify a Memory Map:

1. Start the debugger — the **True-time Simulator & Real-time Debugger** window appears.
2. From debugger main menu, select **FSICEBASE-HC08**
 The FSICEBASE-HC08 menu is between the Run menu and the Component menu. If you do not see the FSICEBASE-HC08 menu, you need to specify the connection. For more information on specifying a connection see [Specifying A Connection](#).
3. Select **Memory Map** — Memory Map dialog box opens ([Figure 17.7](#))

Figure 17.7 Memory Map Dialog Box

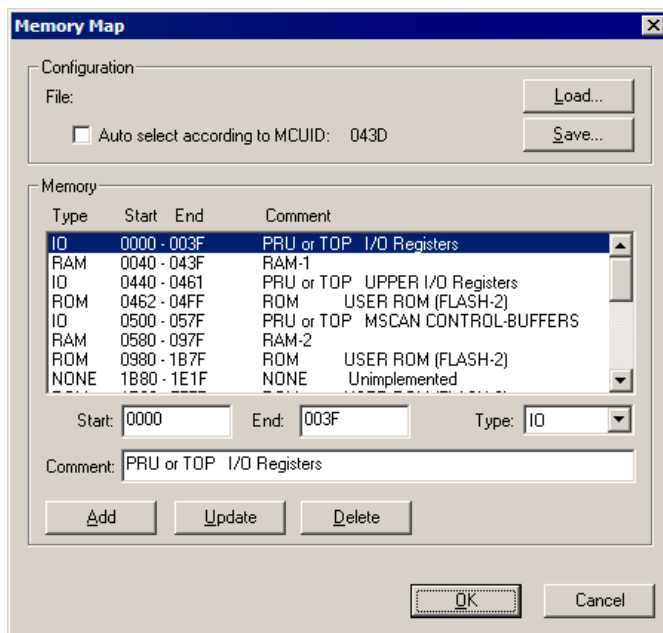

4. Specify memory map information
 - a. From **Memory** list box, select portion of map to change
 - b. In **Start** text box, type new start address of range desired
 - c. In **End** text box, type new end address of range desired
 - d. Select **Type** of memory represented by the new range
 - e. In **Comment** text box, type new description of range if appropriate
 - f. Click **Update** button to update highlighted range, or **Add** button to add a new range (be careful not to overlap ranges)

5. To delete an existing range:
 - a. From Memory list box, select portion of map to delete
 - b. Click **Delete**
6. To Save the definitions of the memory map that you specified:
 - a. Click **Save** — Save Memory Configuration dialog box appears
 - b. In File Name text box, type name you want to give the memory map file (.mem file)
 - c. Click **Save** — debugger saves .mem file, which you can use (load) later
7. Click **OK** — The debugger loads the new memory map information. The Command window of the debugger shows confirmation message.

Specifying the Clock Speed

The FSICEBASE platform board can supply an oscillator clock source for the MCU's OSC1 input. Note that many emulator modules (EMs) require a specific jumper configuration so that this clock source can be used. Refer to the specific EM user's manual for EM clock source information.

The FSICEBASE has seven clock frequencies available: six internally generated clock frequencies (32 MHz, 16 MHz, 8 MHz, 4 MHz, 2 MHz, and 1 MHz) and an external clock source. You can also define a custom internal clock speed.

If you use an external clock source, you need to use a logic clip to connect the clock to the FSICEBASE. You must use logic clip A. Use the white wire to connect to the external clock.

To specify the clock speed:

1. Start the debugger — the **True-time Simulator & Real-time Debugger** window appears.
For more information see [Starting the Debugger](#).
2. From debugger main menu, select **FSCICEBASE-HC08**
The FSICEBASE-HC08 menu is between the Run menu and the Component menu. If you do not see the FSICEBASE-HC08 menu, you need to specify the connection. For more information on specifying a connection see [Specifying A Connection](#).
3. Select **Target Signals** — Target Signals dialog box opens ([Figure 17.8](#))

HC08 FSICEBASE Emulator

Specifying a Memory Map

Figure 17.8 Target Signals Dialog Box

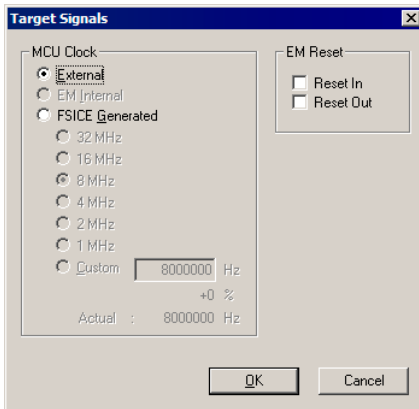

4. Specify clock source. From **MCU Clock** section of dialog box, select whether the clock is connected externally, on a connected emulator module (EM), or FSICE Generated.
5. Specify clock speed if internally generated
 - a. If you selected **FSICE Generated**, select the clock speed to be emulated
 - b. If you selected **Custom**, type clock speed in **Custom** text box

NOTE If you specify a custom clock speed, be aware that the FSICEBASE can provide clock speeds from 4100Hz to 40MHz in steps of 5kHz. The FSICEBASE uses a clock synthesis chip to generate the clock speed. This method is not as accurate as a crystal: only within about 0.75% absolute frequency with about 5% jitter. If you choose a clock value (either from one of the radio buttons or by typing it in) that is an integer divisor of 32MHz or 9.8304MHz, you get an accurate crystal-sourced clock.

6. Click **OK**

The debugger instructs the FSICEBASE to use new clock information. The Command window ([Figure 17.9](#)) of the debugger shows confirmation message.

Figure 17.9 Confirmation Message in Command Window

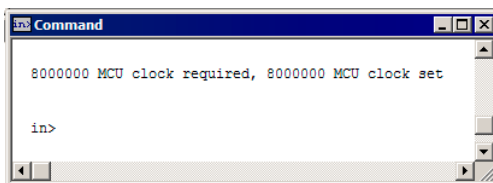

Emulation System Reset

The debugger allows you to reset the emulation MCU and set the PC register to the contents of the reset vector.

To reset the FSICEBASE:

1. If the FSICEBASE is connected to an emulator module (EM), specify the type of reset available to the EM.
 - a. From debugger main menu, select **FSICEBASE-HC08**

The FSICEBASE-HC08 menu is between the Run menu and the Component menu. If you do not see the FSICEBASE-HC08 menu, you need to specify the connection. For more information on specifying a connection see [Specifying A Connection](#).
 - b. Select **Target Signals** — Target Signals dialog box opens ([Figure 17.8](#))
 - c. If you want to allow a reset signal coming from the target system (through the target cable), check the **Reset IN** checkbox.

Some EMs include a hardware jumper that governs target resets. Make sure to configure jumpers as necessary to use the **Reset IN** option. For more information, refer to your EM's documentation.
 - d. To allow a reset signal to be sent to the target system (through the target cable), check the **Reset Out** checkbox.

NOTE If you check both **Reset IN** and **Reset Out** the internal resets of the emulator system are not sent to the target system.

- e. Click **OK**
2. From debugger main menu, select **FSCICEBASE-HC08**
3. Select **Reset**

The debugger sends a reset signal to the FSICEBASE.

Setting Up Logic Cables and Connectors

The diagram below shows the pin numbering for both pod A and pod B logic cable connectors of the station module. [Table 17.1](#) shows the pinout information of the logic clips. You can use the logic clips are used to capture data in the bus state analyzer. (Pin 9 of both pods provides connection to an external ground.) In addition, the pod connectors are used as external clock inputs for the emulator clock and bus state analyzer timetag. The table also provides color code information for each pod. The external clock inputs are through pin 17 of each pod. Pod A pin 17 is the external clock input for the emulator. To

HC08 FSICEBASE Emulator

Setting Up Logic Cables and Connectors

use this source, make the desired clock connection to the white probe tip and use the OSC command to select an external source.

Pod B pin 17 is the external timetag input for the bus state analyzer. To use this source, make the desired clock connection to the white probe tip and use the TIMETAG command to select an external time tag source for the analyzer.

Table 17.1 Pod and Logic Cable Pin Assignments

Pod Pin	Pod A Signal	Pod B Signal	Probe Color
1	LC0	LC8	Brown (BRN)
2	GND	GND	
3	LC1	LC9	Red (RED)
4	GND	GND	
5	LC2	LC10	Orange (ORG)
6	GND	GND	
7	LC3	LC11	Yellow (YEL)
8	GND	GND	
9	LC4	LC12	Green (GRN)
10	GND	GND	
11	LC5	LC13	Blue (BLU)
12	GND	GND	
13	LC6	LC14	Purple (PUR)
14	GND	GND	
15	LC7	LC15	Gray (GRY)
16	GND	GND	
17	EXT_OSC	TT_OSC	White
18	GND	GND	
19	GND	GND	Black
20	GND	GND	

Bus State Analyzer (BSA)

The bus state analyzer (BSA) shows the logical state of the target MCU bus. The BSA takes a snapshot of the MCU bus. It also captures the signals from the logic clips of Pods A, B, and C of the FSICEBASE (24 lines in total). This capturing of data enables you to determine what is occurring in a system without actually disturbing the system.

At the end of each MCU clock cycle, the BSA takes a snapshot of the logical states of the target MCU bus. The analyzer stores the snapshots in the trace buffer, according to its mode. (This action is known as storing cycles.)

NOTE This analyzer is a bus state analyzer. It does not show signal hold or setup times.

To start using the BSA, you need to define patterns of logical states as events (or terms). You also need to specify the analyzer mode: continuous, counted, or any of five sequential modes. This determines which cycles the analyzer stores.

Data collection (cycle storage) begins when you arm the analyzer and start program execution. Data collection continues until execution stops, through a specified number of events, or through a defined sequence of events.

Using BSA

To use the bus state analyzer (BSA) to produce useful data that you can view and analyze, you must:

1. Define events (terms).
2. Arm the BSA.

Defining Events

You define an event by specifying a combination of criteria. You can define the criteria to be particular values in certain addresses, read or write access on an instruction or on data, extended address access, or signals sent through one of the five logic clips that you can connect to Pod A of the FSICEBASE.

The Bus State Analyzer uses the criteria that you specify to create an event, and labels the event A, B, C, or D. When the BSA determines that the criteria of a certain event has been met, depending on the triggering mode, it records the data that is in the bus of the MCU at that particular clock cycle. It also records the data that is in the lines of Pods A, B, and C. You can control the way that the BSA records this information by specifying a recording mode.

HC08 FSICBASE Emulator

Bus State Analyzer (BSA)

To define an event:

1. Start the debugger
2. Load the program to debug
 - a. If you launched the debugger from a project in the CodeWarrior IDE, the debugger automatically loads the program (.abs or .elf file)
 - b. If the debugger has not loaded the program that you want to debug:
 - From the debugger main menu, select *File > Load Application*
 - Specify the location of the executable program file (.abs or .s19 file)
 - Click *Open* — debugger loads the application you specified
3. From debugger main menu, select **FSICBASE-HC08**

The FSICBASE-HC08 menu is between the Run menu and the Component menu. If you do not see the FSICBASE-HC08 menu, you need to specify the connection. For more information on specifying a connection see [Specifying A Connection](#).

4. Select **Bus Analyzer Configuration** — Bus Analyzer Configuration dialog box opens ([Figure 17.10](#))

Figure 17.10 Bus Analyzer Configuration Dialog Box

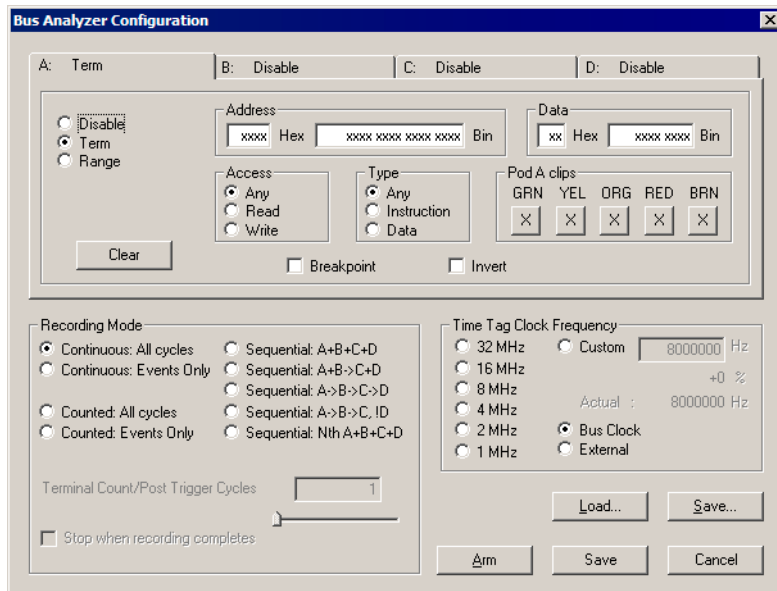

5. Select **Term** or **Range**

A range consists of two 32-bit values. Range does not refer to a range of addresses. If you define an event as a range, the BSA triggers every time the input falls between the range starting term (the first 32-bit value) and the range ending term (the second 32-bit value).

6. In **Address** area, specify the address(es) that the BSA monitors
7. In **Data** area, specify the data that the BSA monitors
8. In **Access** area, specify the type of access that you want the BSA to monitor
9. In **Type** area, specify whether the you want the BSA to record data, instructions or any kind of value at the specified address
10. Specify Pod A signals (logic clips attach to pins of Pod A) that you want the BSA to monitor for this event

NOTE You can use five of the pod A logic clips to define an event. The other signals of Pod A, and the signals of Pods B and C cannot be used to define an event. The Bus Analyzer Configuration dialog box shows the five clips that you can use to trigger an event. The choice of these five signals is hard-set in the FSICEBASE; you cannot choose other signals to be used as event criteria. However, the BSA does capture data from all 24 lines of Pods A, B, and C.

11. If you want the term to also act as a breakpoint, check the **Breakpoint** checkbox.

12. Specify the Recording Mode

- For information about the recording mode, see [Recording Modes](#).
- If you check the **Stop when recording completes** checkbox, the debugger stops program execution when bus state analyzer recording is done.

13. Specify the Time Tag Clock Frequency

14. Click *Save* to apply the event information to the current debug session and close the dialog box. The BSA uses the terms when you arm the BSA.

15. Click *Save* to save the event information to a file.

16. Click *Arm* to ready the BSA to collect data.

The BSA does not start collecting data until execution begins. The debugger indicates that the BSA is armed by showing the word **Armed** in the status bar.

Recording Modes

When you define an event, you can specify the recording mode that the Bus State Analyzer uses to collect data. This section explains how the different modes work.

Continuous: All Cycles

After execution begins, the trace buffer begins storing data from the first cycle. This continues until execution arrives at a breakpoint, or until you halt execution.

Continuous: Events Only

After execution begins, the trace buffer begins storing data when data matches an event definition. This continues until execution arrives at a breakpoint, or until you halt execution.

Counted: All Cycles

After execution begins, the trace buffer begins storing data after the specified number of cycles from first cycle. A breakpoint can stop storage before the analyzer stores the specified number of cycles, as can halting execution.

Counted: Events Only

After execution begins, the trace buffer begins storing data that matches an event definition for the specified number of cycles. A breakpoint can stop storage before the analyzer stores the specified number of cycles; as can halting execution.

A+B+C+D

After execution begins, the trace buffer begins storing data from the first cycle run. This continues through the occurrence of event A, B, C, or D (whichever is enabled); data storage ends after the specified number of post-trigger cycles.

A+B -> C+D

After execution begins, the trace buffer begins storing data from the first cycle. This continues through the occurrence of two events: A or B, followed by C or D. Data storage ends after the specified number of post-trigger cycles.

If you select this mode, you must enable event A, event B, or both. You must enable event C, event D, or both. Otherwise, the bus state analyzer cannot be triggered.

A -> B -> C !D

After execution begins, the trace buffer begins storing data from all cycles. This continues through the occurrence of three events, A, B, and C, in order, if event D does not occur. (If

D occurs, the sequencer starts again looking for event A.) Data storage ends after the specified number of post-trigger cycles.

If you select this mode, you must enable events A, B, and C. Otherwise, the bus state analyzer cannot be triggered. If you disable event D, you convert this mode to a simple, three-event sequence.

A -> B -> C -> D

After execution begins, the trace buffer begins storing data from all cycles. This continues through the occurrence of four events, A, B, C, and D, in order. Data storage ends after the specified number of post trigger cycles.

If you select this mode, you must enable all four events A, B, C, then D. Otherwise, the bus state analyzer cannot be triggered.

Nth Event: A+B+C+D

After execution begins, the trace buffer begins storing data from N occurrences of cycles that match the definitions of events A, B, C, or D (whichever are enabled). Then the bus state analyzer captures the next 4096 cycles.

By selecting the terminal post trigger count, the user can control the number of cycles that is stored. This can be used to speed uploading of the BSA data if only a small portion of data is needed.

NOTE The terminal count or post trigger cycles are valid only for counted or sequential modes. For a counted mode, this field specifies the number of cycles to be stored. For a sequential mode, this field specifies the number of cycles to be stored after the trigger sequence occurs.

Time Tag Clock Frequency

An optional part of analyzer setup is specifying the frequency and source of the time tag clock. This clock provides a time reference value in each frame of the trace buffer. To select the clock frequency, see [Defining Events](#).

You can select from the following frequencies:

- 32 Mhz Selects the 32 MHz oscillator.
- 16 Mhz Selects the 16 MHz oscillator.
- 8 Mhz Selects the 8 MHz oscillator.
- 4 Mhz Selects the 4 MHz oscillator.
- 2 Mhz Selects the 2 MHz oscillator.
- 1 Mhz Selects the 1 MHz oscillator.

HC08 FSICEBASE Emulator

Bus State Analyzer (BSA)

- External Selects the external clock
- Custom selects the programmable clock.
- Bus Clock selects the emulator clock, the bus clock of the emulating MCU.

If you select External, make sure to connect the TT_OSC clip (white) of the pod B cable to the external clock source.

NOTE If you specify a custom clock speed, be aware that the FSICEBASE can provide clock speeds from 4100Hz to 40MHz in steps of 5kHz. The FSICEBASE uses a clock synthesis chip to generate the clock speed. This method is not as accurate as a crystal: only within about 0.75% absolute frequency with about 5% jitter. If you choose a clock value (either from one of the radio buttons or by typing it in) that is an integer divisor of 32MHz, you get an accurate crystal-sourced clock.

Collecting Bus Data

To instruct the Bus State Analyzer (BSA) to start collecting data:

1. From debugger main menu, select **FSCICEBASE-HC08**
2. Select **Arm Trace** — the BSA begins to collect data when the debugger starts execution of the loaded application. The BSA uses the events that you defined in the Bus State Analyzer Configuration dialog box.

Viewing Data

You can view the data collected by the BSA in several formats. You can view: raw data, disassembled instructions, mixed raw data and disassembled instructions, and source code.

To view data:

1. From debugger main menu, select **FSCICEBASE-HC08**
2. Select **Trace** — the **Trace** window opens ([Figure 17.11](#))

Figure 17.11 Debugger Trace Window

Frame	Address	Data	Instruction	Access	Time Tag	Trigger	A-▲
44	1ECC	FB	-	Data read	50663702	Trigger	h
45	1ECC	FB	-	Data read	50663703	Trigger	h
46	1EC8	C7	STA 0xFFFF	Instruction Start	50663704	Trigger	h
47	1EC9	FF	-	Data read	50663705	Trigger	h
48	1ECA	FF	-	Data read	50663706	Trigger	h
49	FFFF	00	-	Data write	50663707	Trigger	h

3. To change the kinds of data and the way that data is displayed:
 - a. Place mouse cursor over Trace window
 - b. Right-click mouse — Menu appears allowing you to change various aspects of the Trace window

The Trace window can display trace buffer contents as raw bus cycles, as disassembled instructions, as mixed instructions and raw bus cycles, or as source code.



HC08 FSICEBASE Emulator
Bus State Analyzer (BSA)

Book III - HCS08 Debug Connections

Book III Contents

Each section of the Debugger manual includes information to help you become more familiar with the Debugger, to use all its functions and help you understand how to use the environment. This book, the HCS08 Debug Connections, defines the connections available for debugging code written for HCS08 CPUs.

This book consists of the following sections:

- [HCS08 Full Chip Simulation](#)
- [HCS08 P&E Multilink/Cyclone Pro Connection](#)
- [HCS08 Open Source BDM Connection](#)
- [HCS08 Serial Monitor Connection](#)
- [SofTec HCS08 Connection](#)
- [HCS08 On-Chip DBG Module](#)
- [Flash Programming](#)



Book III Contents

HCS08 Full Chip Simulation

Full Chip Simulation (FCS) does not involve real input and output. Because of this, it does not require a target device to be connected to your PC. The HCS08FCS connection simulates the execution of code on the user's MCU system, including the function of any peripherals associated with the device that you select. For more detailed information, refer to the Full Chip Simulation description for the module that you are using.

Configuration Procedure

To select Full Chip Simulation as the debugger connection:

1. Choose the Full Chip Simulation option from the set connection dialog box. See [Figure 18.1](#).
2. Click the OK button.

Figure 18.1 Set Connection Dialog Box

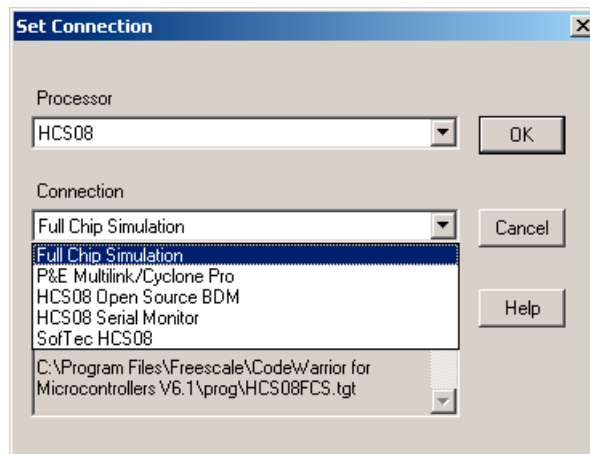

Connection (HCS08FCS) Menu

Once you have chosen Full Chip Simulation as your debugger connection, the name of the Connection menu is updated and addition options are added.

Figure 18.2 HCS08FCS Menu

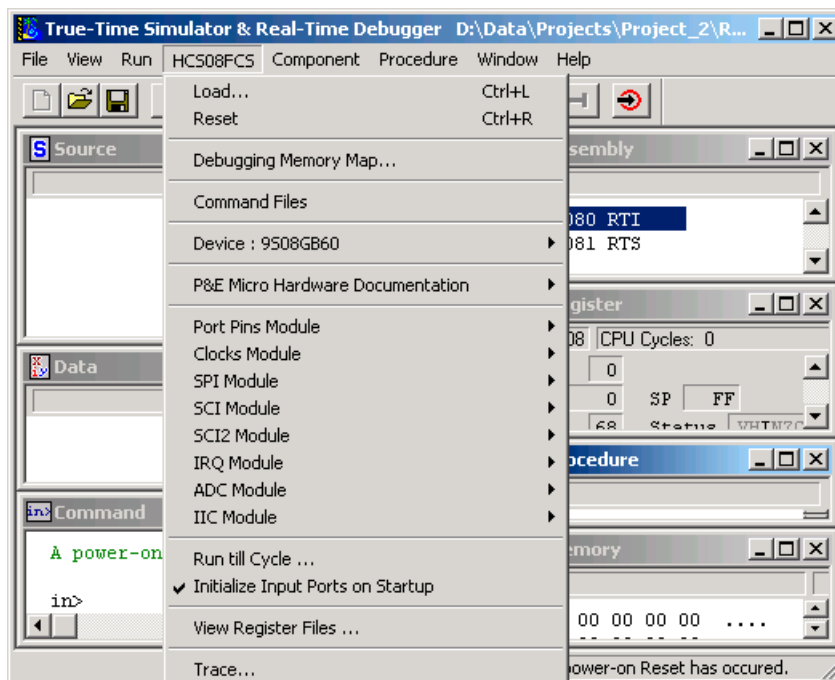

Device Option

The Device selection of the HCS08FCS menu allows the user to select the particular Freescale processor that they wish to use. When choosing the Device option from the HCS08FCS menu, extended menus open which allow you to select the family (e.g. GB Family), and device type (e.g. 9S08GB60) of the MCU that you are using.

Figure 18.3 HCS08FCS Device Extended Menus

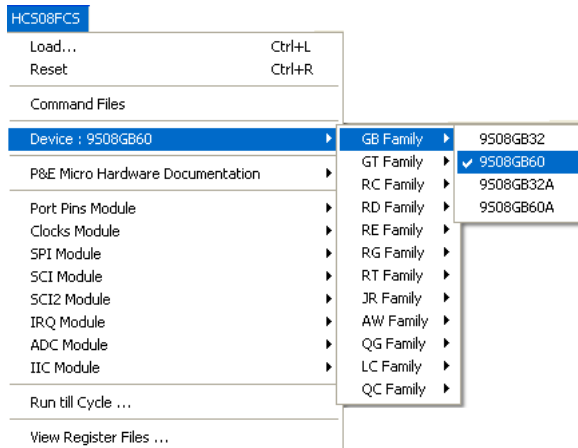

Full Chip Simulation Module Commands

The HC08FCS Menu contains the Full Chip Simulation commands for the modules that have specialty commands associated with them for a chosen device. For more information about specific module commands refer to the Full Chip Simulation section describing the module.

Run Till Cycle Command

The Run Till Cycle command begins code execution, and stops execution when the specified cycle count is reached. Note that the parameter given is not the number of cycles to execute, but the total cycle count of the simulator (displayed in the Register Window).

Use this command to verify specific timings of a given event; run until a given event is complete, or before it completes, to step through the event itself; or in any application where cycle-timed execution is desired.

Initialize Input Ports On Startup

The **Initialize Input Ports on Startup** option initializes all simulated inputs to \$00 when you start the software, or when you switch the Device Mode or Debug Target. This

HCS08 Full Chip Simulation

Configuration Procedure

initialization does not apply to a **reset** command. When you change this option, the new state takes effect the next time you start HiWave (or switch Device Mode/Debug Target).

View Register Files Command

The *View Register Files* selection in the HCS08FCS menu also gives the user the option of running the register file viewer/editor. If register files are available for the device that you have chosen, the **Choose a Register Block** window (see [Figure 18.4](#)) opens. You may also open it by entering the R command in the Command Window command line.

Figure 18.4 Choose A Register Block Dialog Box

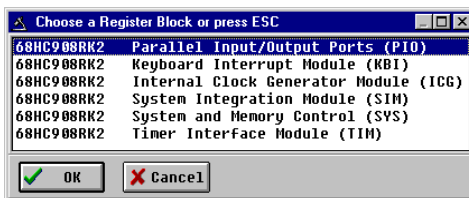

If register files have been installed on the host computer, selecting a block brings up the Register Block register listing (see [Figure 18.5](#)), which shows a list of the files, their addresses, and their descriptions. This begins interactive setup of system registers such as I/O, timer, and COP watchdog.

Figure 18.5 Timer Interface Module Register Listing

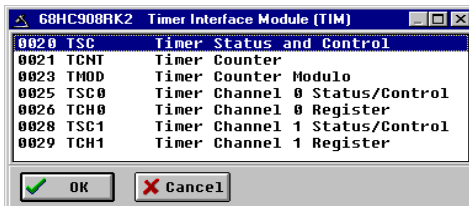

Selecting a file brings up the Register Window (see [Figure 18.6](#)), which displays the values and significance for each bit in the register. The registers can be viewed and their values modified, and the values can be stored back into debugger memory.

Figure 18.6 Register Window

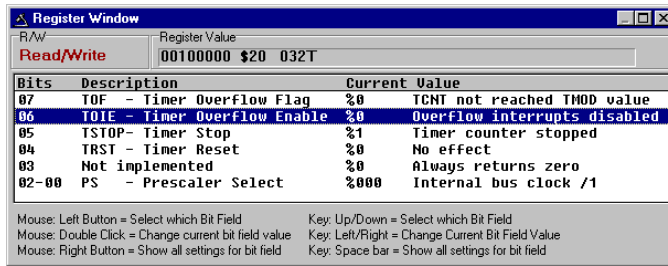

Peripheral Modules Commands

If you select a device (see [Device Option](#)), the HCS08FCS Menu displays a list of peripheral modules and the associated commands for the device you have chosen.

Figure 18.7 HCS08FCS Menu: Peripherals/Commands Extended Menu

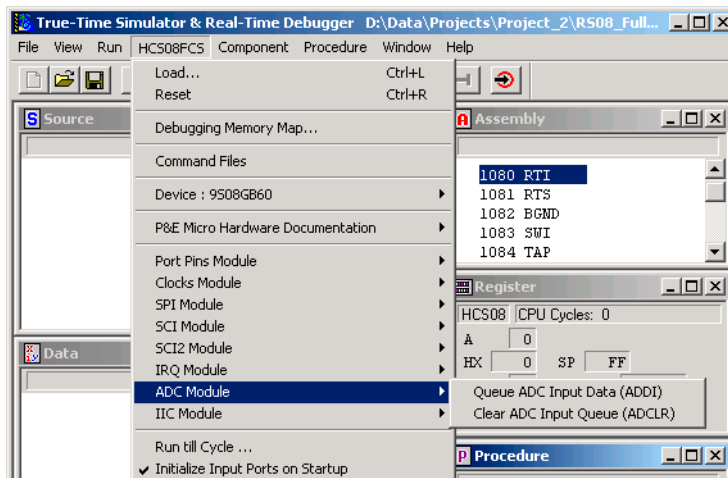

Placing your mouse over a peripheral opens a box which lists its associated commands. Click on a command in order to execute that command.

ADC Module

In Full Chip Simulation (FCS), this module simulates all functionality of the Analog to Digital Conversion (ADC) module including data input on all ADC channels, flag polling, interrupt operation as well as the bus and CGMXCLK reference clock sources. FCS mode uses the buffered input structure to simulate the ADC inputs. The user can queue up to 256 data values. To queue the ADC Input Data, use the ADDI command in the command prompt. If the data parameter is given, the value is placed into the next slot in the input buffer. Otherwise, if no parameter is provided, a window is displayed with the input buffer values. Input values can be entered while the window is open. An arrow points to the next value to be used as input to the ADC. The conversion takes place after a proper value is written to the ADC Status and Control register. Once the conversion occurs, the arrow moves to the next value in the ADC Buffer.

Figure 18.8 ADC IN Buffer Display

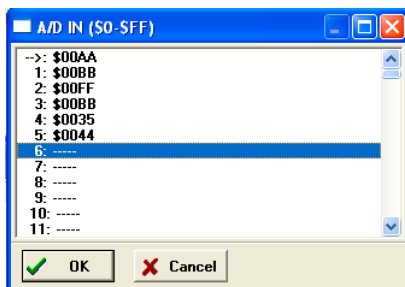

At any point, use the ADCLR command to flush the input buffer for the ADC simulation.

After the conversion is complete, the first queued value is passed from the data buffer into the ADC data register. It can be observed in the memory window by displaying the memory location corresponding to the ADC data register.

Figure 18.9 Memory Component Window

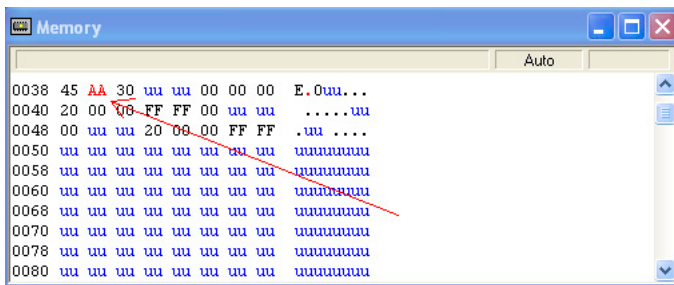

When the conversion is complete, the FCS sets the appropriate flag. If interrupts are enabled, the Program Counter changes flow to the interrupt routine (as defined in the vector space of the MCU). For more information on ADC configuration, refer to the Freescale user manual for your microprocessor.

ADC Module Commands

The following commands are available for the M68HCS08 ADC Module.

ADDI Command

The ADDI command allows the user to input the data into the ADC converter. If a data parameter is given, the value is placed into the next slot in the input buffer. Otherwise, if no parameter is given, a window is displayed with the input buffer values. Input values can be entered while the window is open. An arrow points to the next value to be used by the ADC. The maximum number of input values is 256 bytes.

Syntax

```
>ADDI [<n>]
```

Where:

<n> The value to be entered into the next location in the input buffer.

Example

```
>ADDI $55
```

Set the next input value to the ADDI to \$55

```
>ADDI
```

Pull up the data window with all the input values.

ADCLR

Use the ADCLR command to flush the input buffer for ADC simulation. This resets the input data buffer and clears out all values. Notice that if the ADC is currently using a value, this command does not prevent the ADC from using it. See ADDI command for information on how to access the input buffer of the ADC interface.

Syntax

```
>ADCLR
```

Example

```
>ADCLR
```

Clear the input buffer for ADC simulation.

Clock Generation Module

In FCS, this module simulates all functionality of the Clock Generation Module (ICG), including:

- Phase Locked Loop (PLL) generation
- Automatic lock detection
- Interrupt
- Acquisition
- Tracking
- Flag polling

FCS mode uses simulated External Oscillator Frequency change command (XTAL) to allow the user to input the desired XTAL value. To check the current value of the External Oscillator, Bus Frequency and CGMXCLK Frequency, open the HCS08FCS menu, then select *Clocks Module > Show MCU Clocks*.

Figure 18.10 Clocks Module Extended Menu

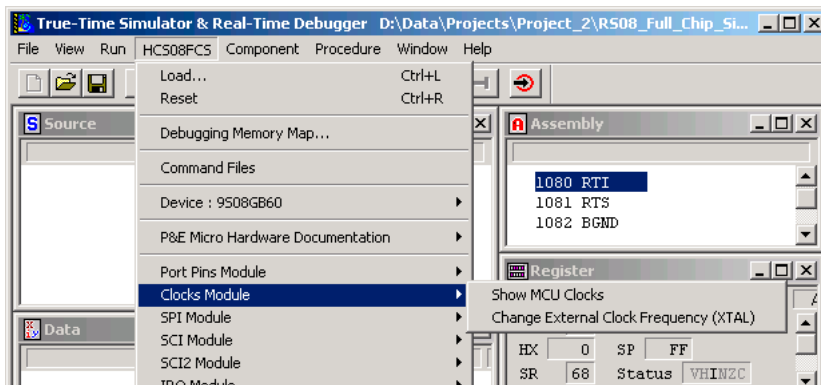

Once you select the MCU Clocks Menu, the Cycles Window displays all of the above-mentioned Clock Frequencies.

Figure 18.11 Frequency Display

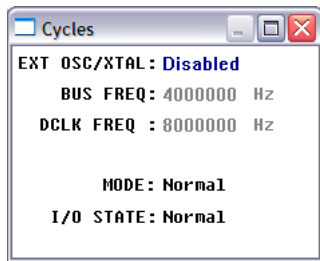

Once the ICG is properly configured, the user can monitor the status of the PLL by polling the corresponding flag. If PLL interrupt is enabled, FCS jumps to an appropriate subroutine, as long as the interrupt vector is properly defined. To observe the flag going up as a result of the corresponding CPU event, situate your Memory Window on the memory location of the ICG Status and Control register.

Figure 18.12 Memory Window

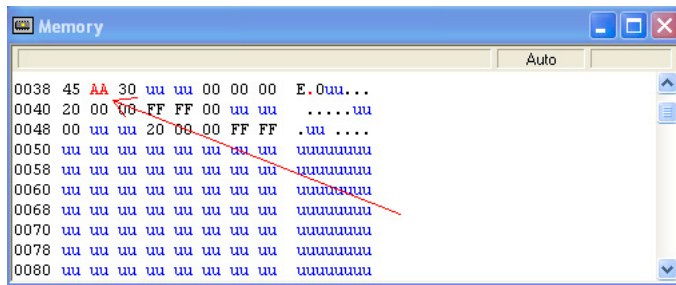

For more information on how to properly configure Clock Generation, refer to the Freescale reference manual for your microprocessor.

Clock Generation Module Commands

The following commands are available for the M68HCS08 Clock Generation Module.

XTAL Command

Use the XTAL command to change the value of the simulated external oscillator. This in turn affects the input to the PLL/DCO, and therefore the bus frequency. The P&E simulator is a cycle-based simulator, so changing the XTAL value does not affect the

HCS08 Full Chip Simulation

Peripheral Modules Commands

speed of simulation; it does, however, affect the ratio in which peripherals receive cycles. Certain peripherals which run directly from the XTAL run at different speeds than those that run from the bus clock.

Syntax

```
>XTAL <n>
```

Where:

- <n>, by default, is a hexadecimal number, representing the simulated frequency of an external oscillator. Adding the suffix `t` to the `n` parameter forces the input value to be interpreted as base 10.

Example

```
>XTAL
```

Brings up an input window. The default base for this input value is 10. However, this value can be forced to a hexadecimal format through use of the suffix `h`.

Inter-Integrated Circuit Module

In FCS, this module simulates all functionality of the Inter-Integrated Circuit (IIC) module including:

- Flag polling
- Interrupt enabled mode
- Transmission and reception of external data
- Master and slave modes of operation
- START and STOP signal generation detection
- Acknowledge bit generation detection

FCS mode uses the buffered input/output structure to simulate IIC inputs. The user can queue up to 256 data bytes into the input buffer. The output buffer of the USB module can also hold 256 output bytes. To queue the IIC Input Packets, use the `IICDI <...>` command in the command prompt. For a more detailed description of the command, refer to the IIC Commands section. If the IIC packet parameters are properly defined, the packet is placed into the next slot in the input buffer. Otherwise, if no parameters are provided, an IIC Input Buffer window is displayed.

The user can enter different IIC packet parameters while the window is open, including START, STOP, ACK, NACK and data bytes. An arrow points to the next byte to be used as input to the IIC. The data from the IIC input buffer is written to the IIC module registers once the IIC module is turned on and properly configured for receiving data from an external IIC device. Once simulation of the data transmission is over, the arrow moves to the next value in the IIC Input Buffer.

Figure 18.13 IIC Input Buffer Display

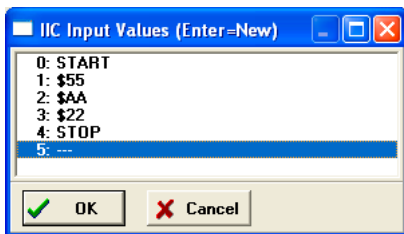

The IIC data input/output log buffer simulation allows the user to gain access to the past 256 IIC data bytes that have been shifted in and out of the module. To bring up the IIC IN/OUT LOG buffer dialog box, use the IICDO command.

Figure 18.14 IIC IN/OUT LOG Buffer Display

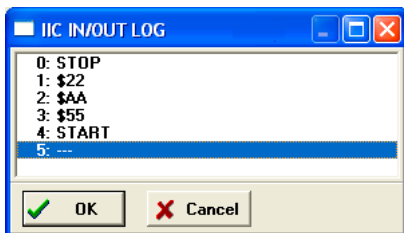

At any point, use the IICCLR command to flush the input as well as input/output log IIC buffers.

After the IIC simulated input is received, the first queued-in data byte is passed from the data buffer into the corresponding IIC module registers. It can be observed in the Memory Window by displaying the appropriate register location there.

Figure 18.15 Memory Component Window

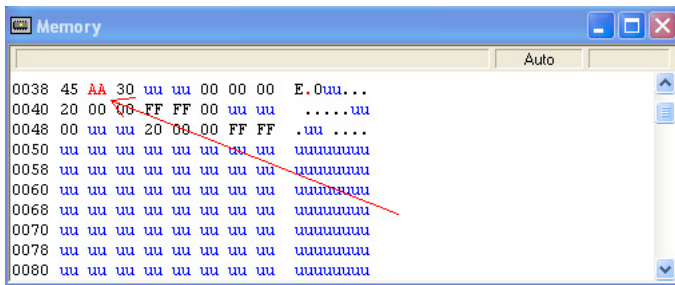

The user can also observe different IIC flags in the Memory Window. If you run the module in Flag Polling mode, poll the flag corresponding to the expected IIC event. If the

IIC interrupts are enabled, the FCS jumps to an appropriate subroutine as long as the IIC interrupt vectors are properly defined.

For more information on how to configure IIC module for desired operation, refer to the Freescale user manual for your microprocessor.

Inter-Integrated Circuit Module Commands

The following commands are available for the M68HCS08 Inter-Integrated Circuit Module.

IICDI Command

The IICDI command allows the user to input data into a buffer of data to shift into the IIC module when it receives data from an external device. If a data parameter is given, the value is placed into the next slot in the input buffer. Otherwise, if no parameter is given, a window is displayed with the input buffer values. Input values can be entered while the window is open. The maximum number of input values is 256.

This command is useful for either inputting response data from a slave target or for inputting data packets from an external master. Note that when the microprocessor attempts to read an acknowledge from an external device, and the next value in the buffer is neither ACK nor NACK, the microprocessor automatically receives an ACK signal (i.e. assumes ACK unless NACK is specified).

Syntax

```
>IICDI [<n>] [START] [STOP] [ACK] [NACK]
```

Where:

- <n> indicates the value to be entered into the next location in the input buffer
- START indicates the incoming START signal
- STOP indicates the incoming STOP signal
- ACK corresponds to ACK signal
- NACK corresponds to NACK signal

For a detailed description of the IIC protocol and a proper way to configure the IIC module, refer to the Freescale user manual for your microprocessor.

Example

```
>IICDI
```

Pulls up the data window with all the input values

```
>IICDI 22 33
```

This is an example of data being returned from a slave device. Once the MCU transmits a start signal and the target address, it receives an ACK from the slave device. An ACK is implied unless a NACK is specified via the IICDI command. The next two data bytes read are 22 and 23. If the microprocessor attempts to read another byte, it gets an \$FF value followed by a NACK signal (NACK because nothing remains in the input buffer). The receiving device then generates a STOP signal. A more exact input from a device designed to return two bytes is:

```
>IICDI ACK 22 ACK 23 NACK
```

IIC in master mode transmits to a slave:

- If the slave device acknowledges all output bytes of the transmitting device, there is no need to specify an input packet. If the master device is going to transmit an address and two bytes, the following packet is equivalent to no packet:

```
>IICDI ACK ACK ACK
```

- If, however, the slave receiver is designed to generate a NACK signal after the second received data byte, the proper response packet is:

```
>IICDI ACK ACK NACK
```

- The address result being the first ACK, the first data result being the second ACK, and the second data byte being the NACK.

IIC in MASTER mode is not acknowledged by any Slave:

```
>IICDI NACK
```

- If the NACK signal is entered before our master device transmits a START signal, then the master device gets a NACK when it tries to read an acknowledge after the address is output. The master device then generates a STOP signal and releases the BUS.

IIC in SLAVE mode receives a Write from an external Master:

This example is for an external master which is writing to the microprocessor configured to simulate the slave mode operation. The packet contains both START and STOP signals which puts the simulated device into the slave mode.

```
>IICDI START 55 AA 22 STOP
```

This input adds five values to the input queue which is a packet from an external master, including the following procedure values:

1. A start signal comes in
2. The address \$55 comes, in specifying a write (slave receive). The Address Register in the current simulated device has been previously set to \$55

HCS08 Full Chip Simulation

Peripheral Modules Commands

3. The data byte \$AA comes in
 4. The data byte \$22 comes in
 5. A STOP signal comes in
-

IICDO Command

The `IICDO` command displays a window, which shows data shifted in as well as shifted out of the IIC peripheral. An arrow points to the last output value transmitted/received. The maximum number of output values that the buffer can hold is 256.

Syntax

```
>IICDO
```

Example

```
IICDO
```

View data from the input/output log buffer for IIC simulation.

IICCLR Command

Use the `IICCLR` command to flush the input and output buffers for IIC simulation. This resets the buffers and clears all values. Notice that if the IIC is currently shifting a value, this command does not prevent the IIC from finishing the transfer.

Syntax

```
>IICCLR
```

Example

```
>IICCLR
```

Clear input and output buffers for IIC simulation.

Input/Output (I/O) Ports Module

In FCS, this module simulates all input and output functionality of the Input/Output (I/O) Ports module. FCS mode uses a set of designated commands to simulate the input and output activity on corresponding I/O port pins. To define an input state of the specific port, write the `INPUT <x> <n>` command in the Command line window. The `<x>` represents corresponding I/O port, while the `<n>` stands for the input value to write to this port. At

the same time, you can use the `INPUTS` command to bring up the Simulated Port Inputs for all general I/O ports. It displays the current simulated values to all applicable input ports. See the [Input/Output Ports User Commands](#) and [Input/Output Ports User Commands](#) for more information about the various forms of this command.

Figure 18.16 Simulated Port Inputs Dialog Box

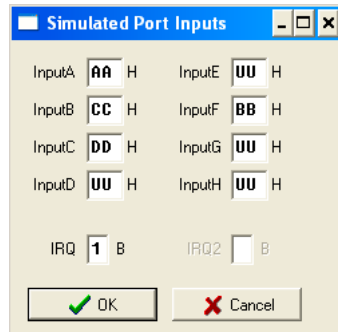

Use the Simulated Port Inputs dialog box to reconfigure the input value to any I/O port. Use the `INPUTS` command to reconfigure the output values on any relevant I/O port. You can observe the manipulation of I/O port pins in the Memory Window.

Figure 18.17 Memory Component Window

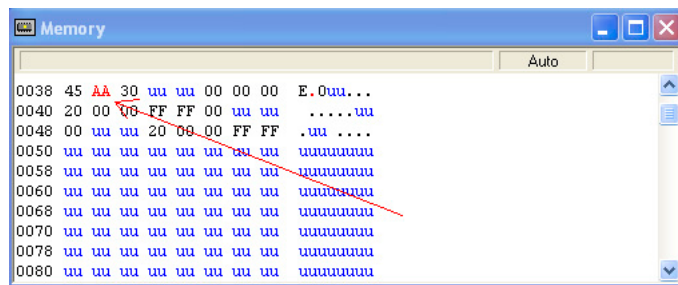

Note that if the regular I/O pins are multiplexed to be used by a different MCU Module, they might not be available for general I/O functionality. For more information on how to properly configure I/O pins, refer to the Freescale user manual for your microprocessor.

Input/Output Ports User Commands

The following user commands are available for accessing the M68HCS08 I/O ports.

INPUT<x> Command

The `INPUT<x>` command sets the simulated inputs to port `<x>`. The CPU reads this input value when port `<x>` is set as an input port.

Syntax

```
>INPUT<x> <n>
```

Where:

`<x>` is the letter representing corresponding port

`<n>` Eight-bit simulated value for port `<x>`

Example

```
>INPUTA AA
```

Simulate the input AA on port A.

INPUTS Command

In FCS and CPU-Only Simulation mode, the `INPUTS` command opens the Simulated Port Inputs dialog box shown in [Figure 18.18](#). The user may then use this box to specify the input states of port pins and IRQ.

Figure 18.18 Simulated Port Inputs Dialog Box

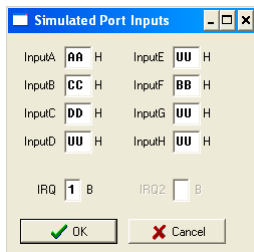

When using In-Circuit Simulation mode, the `INPUTS` command shows the simulated input values to any applicable port.

Syntax

```
>INPUTS
```

Example

```
>INPUTS
```

Show I/O port input values.

External Interrupt (IRQ) Module

In FCS, this module simulates the input, flag polling and interrupt functionality of the External Interrupt (IRQ) module. FCS mode uses the `INPUTS` command to let the user monitor and change the simulated value of the IRQ input pin state. Once the user enters the `INPUTS` command into the command line prompt, the Simulated Port Inputs window appears. See [INPUT<>> Command](#) for more information about the various forms of this command. In addition, you can modify the state of the IRQ pin directly using the `IRQ <n>` command (documented below).

HCS08 Full Chip Simulation

Peripheral Modules Commands

Figure 18.19 Simulated Port Inputs Dialog Box

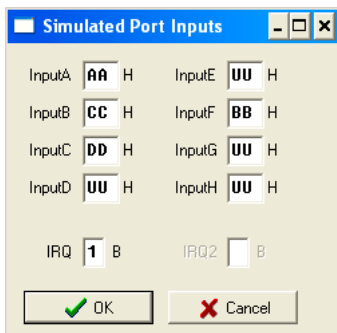

An IRQ event occurrence sets the appropriate flag in the corresponding IRQ register. The user can poll the IRQ flag if the Polling Mode is simulated. In the Interrupt Mode, the simulator branches to an appropriate interrupt subroutine as long as the IRQ interrupt vector is properly configured. For more information on IRQ configuration, refer to the Freescale user manual for your microprocessor.

Following the IRQ event, you can observe the IRQ Flag being set in the IRQ Status and Control register.

Figure 18.20 Memory Component Window

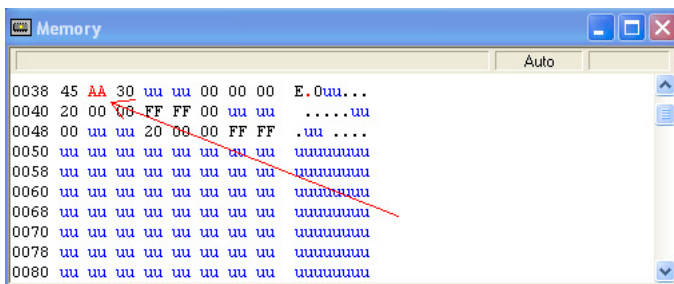

IRQ Commands

The following interrupt request command is available for the HCS08.

INPUTS Command

In FCS and CPU-Only Simulation mode, the `INPUTS` command opens the Simulated Port Inputs dialog box shown in [Figure 18.21](#). The user may then use this box to specify the input states of port pins and IRQ.

Figure 18.21 Simulated Port Inputs Dialog Box

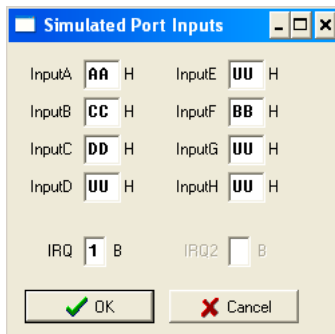

When using In-Circuit Simulation mode, the `INPUTS` command shows the simulated input values to any applicable port.

Syntax

```
>INPUTS
```

Example

```
>INPUTS
```

Show I/O port input values.

NOTE The IRQ pin state can be directly manipulated with the `IRQ` command. For example, `IRQ 1` simulates a high state on the IRQ pin; likewise, `IRQ 0` simulates a logic-low state on the IRQ pin.

Keyboard Interrupt Module

In FCS, this module simulates all functionality of the Keyboard Interrupt (KBI) module, including the edge-only, edge and level interrupt, and flag polling modes of operation. FCS mode uses simulated port inputs to trigger the KBI event from the proper I/O port pin. To define an input state of the specific port, write the `INPUT<x> <n>` command in the Command line window. The `<x>` represents the corresponding I/O port, while `<n>` stands for the input value to write to this port. At the same time, you can use the `INPUTS` command to bring up the Simulated Port Inputs for all general I/O ports. It displays the current simulated values to all applicable input ports. See the documentation for [Timer Module Commands](#) for more information about the various forms of this command.

Figure 18.22 Simulated Port Inputs Dialog Box

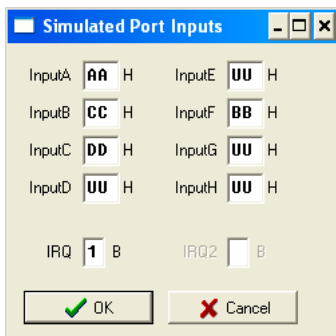

Use the Simulated Port Inputs dialog box to reconfigure the input value to any I/O port. To trigger the event, manipulate the inputs to the port in the appropriate manner, depending on whether the KBI is configured for edge-only or edge and level. Once the KBI event takes place, you can observe the KEYF Flag bit, which is a part of the Keyboard Status and Control register, in the Memory Window.

Figure 18.23 Memory Component Window

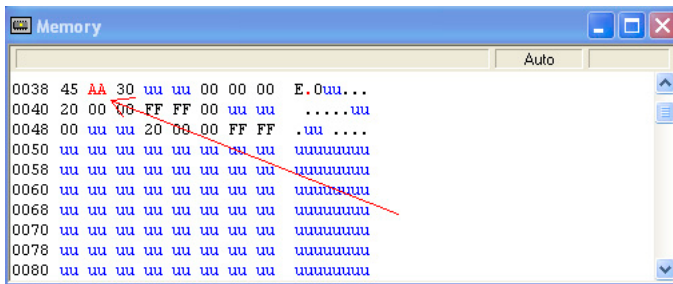

The user can poll the KBI Interrupt Pending flag if the Polling Mode is simulated. In Interrupt Mode, the simulator branches to an appropriate interrupt subroutine as long as the KBI interrupt vector is properly configured. For more information on KBI configuration, refer to the Freescale user manual for your microprocessor.

Keyboard Interrupt Commands

The following Keyboard interrupt commands are available during full chip simulation on the HCS08.

INPUT<x> Command

The INPUT<x> command sets the simulated inputs to port <x>. The CPU reads this input value when port <x> is set as an input port.

Syntax

```
>INPUT<x> <n>
```

Where:

<x> is the letter representing corresponding port

<n> is an eight-bit simulated value for port <x>

Example

```
>INPUTA AA
```

Simulate the input AA on port A.

INPUTS Command

In FCS and CPU-Only Simulation mode, the INPUTS command opens the Simulated Port Inputs dialog box shown in [Figure 18.24](#). The user may then use this box to specify the input states of port pins and IRQ.

Figure 18.24 Simulated Port Inputs Dialog Box

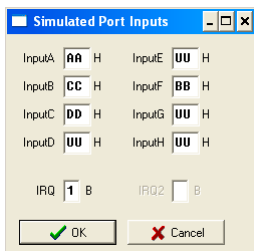

When using In-Circuit Simulation mode, the `INPUTS` command shows the simulated input values to any applicable port.

Syntax

```
>INPUTS
```

Example

```
>INPUTS
```

Show I/O port input values.

Modulo Timer Interrupt Module

In FCS, this module simulates all functionality of the Modulo Timer Interrupt (MTIM) Module, including:

- programmable MTIM clock input
- free running or modulo up count operation
- flag polling
- interrupt enabled mode of operation

Once the MTIM Status and Control register properly configures the operation of the module, the MTIM Counter starts incrementing. If modulo up count operation is enabled, you can observe the MTIM overflow flag in the MTIM Status and Control register in the Memory Window.

Figure 18.25 Memory Component Window

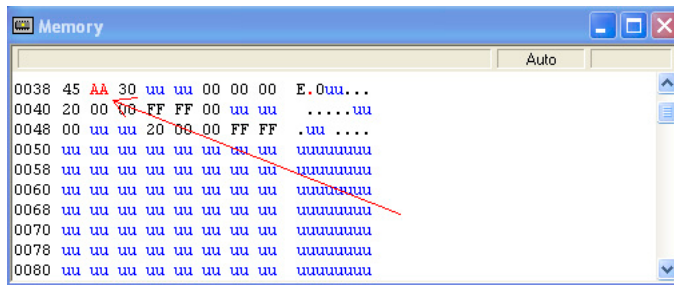

If the MTIM interrupt is enabled, the FCS jumps to an appropriate subroutine as long as the MTIM interrupt vector is properly defined.

Serial Communications Interface Module

In FCS, this module simulates all functionality of the Serial Peripheral Interface (SPI) module including:

- Flag polling
- Interrupt enabled mode
- 8- or 9-bit length data codes
- Odd and even parity modes
- Transmission and reception of external data

FCS mode uses the buffered input/output structure to simulate SCI inputs. The user can queue up to 256 data values into the input buffer. The output buffer of the SCI module can also hold 256 output values. To queue the SCI Input Data, use the `SCDI <n>` command in the command prompt. If `<n>` (the data parameter) is given, the value is placed into the next slot in the input buffer.

Otherwise, if no parameter is provided, a window is displayed with the input buffer values. You can enter input values while the window is open. An arrow points to the next value to be used as input to the SCI. The data from the SCI input buffer is written to the SCI data register once the SCI module has been turned on and is properly configured for receiving data from an external serial device. Once the simulation of the data transmission is over, the arrow moves to the next value in the SCI IN Buffer.

HCS08 Full Chip Simulation

Peripheral Modules Commands

Figure 18.26 SCI IN Buffer Display

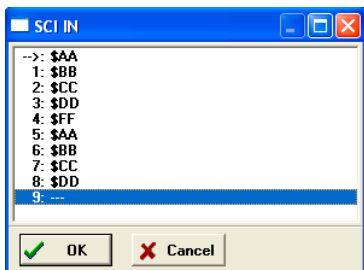

SCI Data Output Buffer simulation allows the user to gain access to the past 256 SCI data values transmitted out of the module. To bring up the SCI OUT buffer dialog box, use the SCDO command.

Figure 18.27 SCI OUT Buffer Display

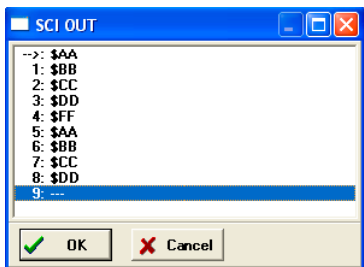

At any point, use the SCCLR command to flush the input and output SCI buffers.

After the SCI simulated input is received, the first queued value is passed from the data buffer into the SCI data register. It can be observed in the memory window by displaying the memory location corresponding to the SCI data register.

Figure 18.28 Memory Component Window

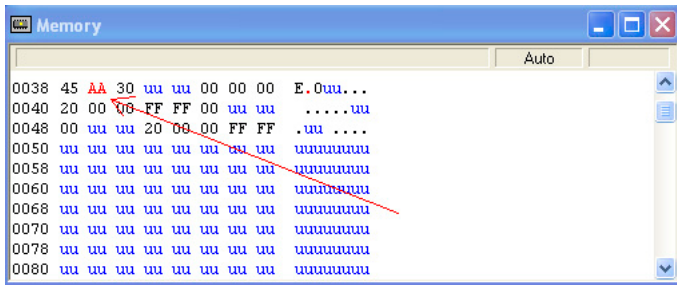

The user can also observe different SCI flags in the Memory window. If the module is run in Flag Polling mode, poll the flag corresponding to the expected SCI event. If the SCI interrupts are enabled, the FCS jumps to an appropriate subroutine as long as the SCI interrupt vectors are properly defined.

For more information on how to configure SCI module for desired operation, refer to the Freescale user manual for your microprocessor.

SCI Commands

The following serial communication interface commands are available for the HCS08.

SCCLR Command

Use the SCCLR command to flush the input and output buffers for SCI simulation. This resets the buffers and clear out all values. Notice that if the SCI is in the process of shifting a value, this command does not prevent the SCI from finishing the transfer. See SCDI command and SCDO command for accessing the input and output buffers of the SCI interface.

Syntax

```
>SCCLR
```

Example

```
>SCCLR
```

Clear input and output buffer for SCI simulation

SCDI Command

The SCDI command allows the user to input data into the SCI. If a data parameter is given, the value is placed into the next slot in the SCI input buffer. Otherwise a window is displayed with the input buffer values. Input values can be entered while the window is open. An arrow points to the next value to be used as input to the SCI. The maximum number of input values is 256 bytes.

Syntax

```
>SCDI [<n>]
```

Where:

><n> The value to be entered into the next location in the input buffer

HCS08 Full Chip Simulation

Peripheral Modules Commands

Example

```
>SCDI $55
```

Set the next input value to the SCI to \$55

```
>SCDI
```

Pull up the data window with all the input values.

Figure 18.29 SCI IN buffer display

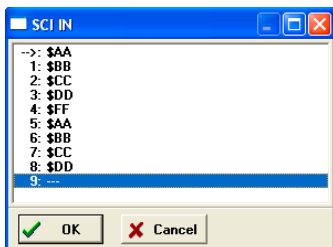

SCDO Command

The SCDO command displays the output buffer from the SCI. A window is opened that shows all the data that the SCI has shifted out. An arrow is used to point to the last output value transmitted. The maximum number of output values that the buffer holds is 256 bytes.

Syntax

```
>SCDO
```

Example

```
>SCDO
```

View data from the output buffer for the SCI simulation.

Figure 18.30 SCI OUT Buffer Display

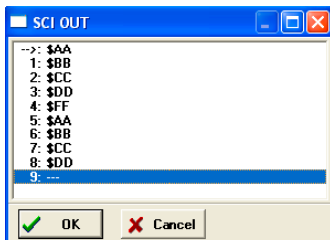

Serial Peripheral Interface Module

In FCS, this module simulates all functionality of the Serial Peripheral Interface (SPI) module including:

- flag polling
- interrupt enabled mode
- master and slave modes
- slave input clock
- transmission and reception of external data

FCS mode uses the buffered input/output structure to simulate SPI inputs. The user can queue up to 256 data values into the input buffer. The output buffer of the SPI module can also hold 256 output values. To queue the SPI Input Data, use the `SPDI <n>` command at the command prompt. If `<n>` (the data parameter) is given, the value is placed into the next slot in the input buffer.

Otherwise a window is displayed with the input buffer values. You can enter input values while the window is open. An arrow points to the next input value to the SPI. The data from the SPI input buffer is written to the SPI data register once the SPI module is turned on and is properly configured for receiving data from an external serial device. Once the simulation of the data transmission is over, the arrow moves to the next value in the SPI IN Buffer.

Figure 18.31 SPI IN Buffer Display

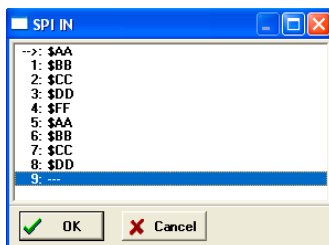

SPI data output buffer simulation allows the user to gain access to the past 256 SPI data values transmitted out of the module. To bring up the SPI OUT buffer dialog box, use the `SPDO` command.

HCS08 Full Chip Simulation

Peripheral Modules Commands

Figure 18.32 SPI OUT Buffer Display

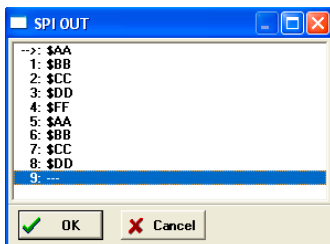

At any point, you can use the `SPCLR` command to flush the input and output SPI buffers. After the SPI simulated input is received, the first queued value is passed from the data buffer into the SPI data register. It can be observed in the Memory Window by displaying the memory location corresponding to the SPI data register.

Figure 18.33 Memory Component Window

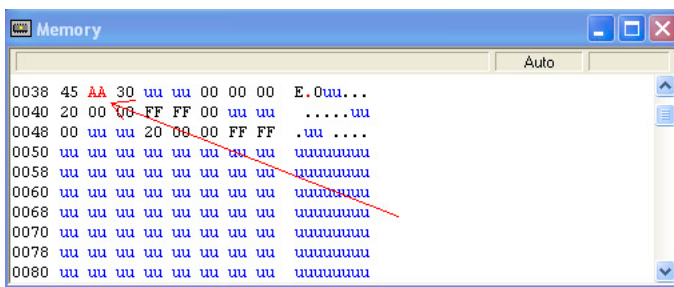

The user can also observe different SPI flags, in the Memory window. If the module is run in the Flag Polling mode, poll the flag corresponding to the expected SPI event. If the SPI interrupts are enabled, the FCS jumps to an appropriate subroutine as long as the SPI channel interrupt vectors are properly defined.

To simulate the frequency of the SPI slave input clock, use the `SPFREQ <n>` command. If the SPI is configured for slave mode, this command allows the user to enter the number of cycles `<n>` in the period of the input clock. If the `SPFREQ` command is not used, then clocking is set by the SPI control register.

For more information on how to configure the SPI module for desired operation, refer to the Freescale user manual for your microprocessor.

SPI Commands

The following serial peripheral interface commands are available for the HCS08.

SPCLR Command

Use the SPCLR command to flush the input and output buffers for SPI simulation. This resets the buffers and clears out all values. Notice that if the SPI is currently shifting a value, this command does not prevent the SPI from finishing the transfer. See SPDI command and SPDO command for accessing the input and output buffers of the SPI interface.

Syntax

```
>SPCLR
```

Example

```
>SPCLR
```

Clear input and output buffer for SPI simulation

SPDI Command

The SPDI command allows the user to input data into the SPI. If a data parameter is given, the value is placed into the next slot in the SPI input buffer. Otherwise, if no parameter is given, a window is displayed with the input buffer values. Input values can be entered while the window is open. An arrow points to the next input value to the SPI. The maximum number of input values is 256 bytes.

Syntax

```
>SPDI [<n>]
```

Where:

<n> The value to be entered into the next location in the input buffer

Example

```
>SPDI $55
```

Set the next input value to the SPI to \$55

```
>SPDI
```

Pull up the data window with all the input values.

Figure 18.34 SPI IN Buffer Display

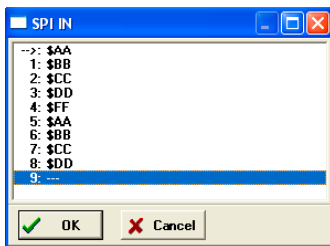

SPDO Command

The SPDO command displays the output buffer from the SPI. A window is opened that shows all the data that the SPI has shifted out. An arrow is used to point to the last output value transmitted. The maximum number of output values that the buffer holds is 256 bytes.

Syntax

>SPDO

Example

>SPDO

View data from the output buffer for the SPI simulation.

Figure 18.35 SPI OUT Buffer Display

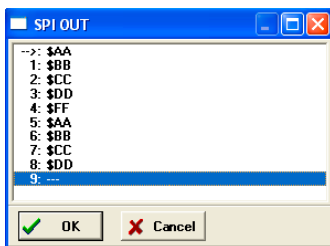

SPFREQ Command

The `SPFREQ` command lets the user set the frequency of the SPI slave input clock. If the SPI is configured for the slave mode, this command allows the user to enter the number of cycles `<n>` per one input clock period. If no value is given, a window appears and the user is prompted for a value. If this command is not used, then the clocking is assumed to be set by the SPI control register.

Syntax

```
>SPFREQ [<n>]
```

Where:

`<n>` The number of cycles for the period of the input clock.

Example

```
>SPFREQ 8
```

Set the period of the input slave clock to 8 cycles (total shift = 8×8 cycles per bit = 64 cycles)

Timer Interface Module

In FCS, this module simulates all functionality of the Timer Interface module, including:

- Input capture/output compare
- Pulse width modulation
- Internal or external clock input
- Free running or modulo up count operation
- Flag polling
- Interrupt enabled mode of operation.

FCS mode uses the simulated port inputs to trigger the input capture on a given timer channel. To define an input state of the specific port, use the `INPUT<x> <n>` command in the Command line window. The `<x>` represents the corresponding I/O port, while `<n>` stands for the input value to write to this port. At the same time, you can use the `INPUTS` command to display the Simulated Port Inputs for all general IO ports. It displays the current simulated values to all applicable input ports. See the documentation for [Timer Module Commands](#) for more information about the various forms of this command.

HCS08 Full Chip Simulation

Peripheral Modules Commands

Figure 18.36 Simulated Port Inputs Dialog Box

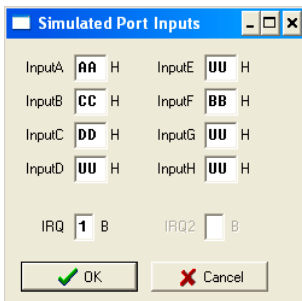

Use the Simulated Port Inputs dialog box to reconfigure the input value to any I/O port. Depending on whether the input capture is set for rising/falling edge, to trigger the event, first set the port inputs high or low and then invert them to an opposite value. Once the Input Capture event takes place, you can observe the CHxF in the Channel Status and Control register in the Memory window.

Figure 18.37 Memory Component Window

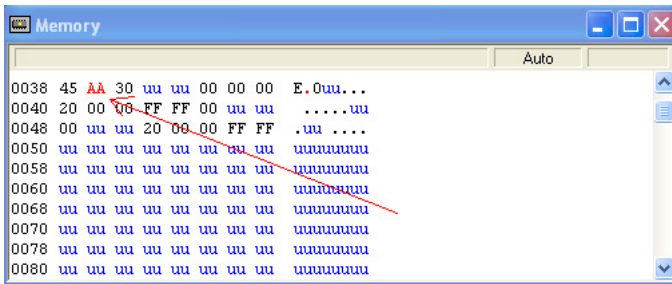

If the Timer module is configured for an Output Compare event, then once the event takes place you can observe the same CHxF Flag via the Memory window. If the timer channel interrupt is enabled, the FCS jumps to an appropriate subroutine as long as the Timer channel interrupt vector is properly defined. To observe the Timer Overflow Flag (TOF) flag being set as a result of the corresponding CPU event, situate your Memory window on the memory location of the Timer Status and Control register.

To observe the Pulse Width Modulation (PWM) operation, properly configure the Timer to operate in the Modulo up count mode, choose the toggle-on-overflow or clear/set output on compare events to create the desired duty cycle wave. Once a PWM event takes place, you can observe pin toggle/clear/set behavior corresponding to the Timer configuration in the Memory window displaying the IO port associated with a given timer channel.

To observe the accuracy of the Timer module operation, the user can observe the number of CPU cycles that it takes for the event to occur. The cycle counter is only incremented as

the user steps through the code. To determine the exact amount of cycles over which the event occurs, one can either observe the cycle display in the Register window or use the built in simulation commands. To display the current number of cycles in the Command window, use the `CYCLES` command. To change the number of cycles in the cycle counter, use `CYCLES <n>`, where `<n>` is the new cycle value. If the event has a pre-calculated number of cycles, use `CYCLE 00` to reset the number of cycles and `GOTOCYCLE <n>` to run through the code until you reach the expected event.

Figure 18.38 Register Window With Cycles Display

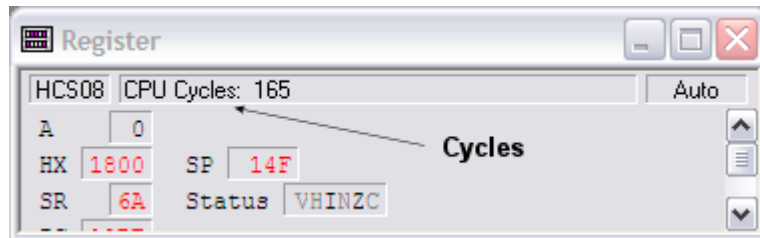

Timer Module Commands

The following timer module commands are available for use with the HCS08.

CYCLES Command

The `CYCLES` command changes the value of the cycles counter. The cycles counter counts the number of the processor cycles that have passed during execution. The Cycles Window shows the cycle counter. The cycle count can be useful for timing procedures.

Syntax

```
>CYCLES <n>
```

Where:

`<n>` Integer value for the cycles counter

Examples

```
>CYCLES 0
```

Reset cycles counter

```
>CYCLES 1000
```

Set cycle counter to 1000.

GOTOCYCLE Command

The GOTOCYCLE command executes the program in the simulator beginning at the address in the program counter (PC). Execution continues until the cycle counter is equal to or greater than the specified value, until a key or the Stop button on the toolbar is pressed, until it reaches a break point, or until an error occurs.

Syntax

```
GOTOCYCLE <n>
```

Where:

<n> Cycle-counter value at which the execution stops

Example

```
>GOTOCYCLE 100
```

Execute the program until the cycle counter equals 100.

INPUT<x> Command

The INPUT<x> command sets the simulated inputs to port <x>. The CPU reads this input value when port <x> is set as an input port.

Syntax

```
INPUT<x> <n>
```

Where:

<x> is the letter representing corresponding port

<n> Eight-bit simulated value for port <x>

Example

```
>INPUTA AA
```

Simulate the input AA on port A.

INPUTS Command

In FCS and CPU-Only Simulation mode, the `INPUTS` command opens the Simulated Port Inputs dialog box shown in [Figure 18.39](#). The user may then use this box to specify the input states of port pins and IRQ.

Figure 18.39 Simulated Port Inputs Dialog Box

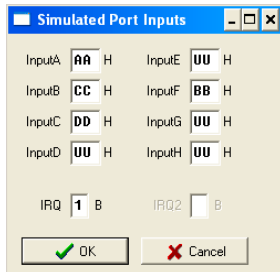

When using In-Circuit Simulation mode, the `INPUTS` command shows the simulated input values to any applicable port.

Syntax

```
>INPUTS
```

Example

```
>INPUTS
```

Show I/O port input values.



HCS08 Full Chip Simulation

Peripheral Modules Commands

HCS08 P&E Multilink/ Cyclone Pro Connection

The HCS08 P&E Multilink/Cyclone Pro Connection setting permits a connection to Multilink/Cyclone Pro devices. HCS08 P&E Multilink/Cyclone Pro connection mode allows the user to debug code, as the firmware is fully resident in the Flash of the microprocessor. The operation of all modules fully reflects the actual operation of the on-board resources.

Connection Procedure

To select the P&E Multilink/Cyclone Pro as your debugger connection:

1. Choose the P&E Multilink/Cyclone Pro option from the set connection dialog box as shown in [Figure 19.1](#).
2. Click the *OK* button.

Figure 19.1 Set Connections Dialog Box

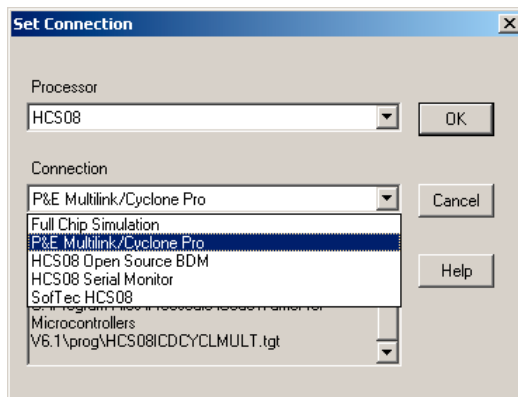

3. Choose the P&E device that you are using from the Connection drop-down menu and click on Refresh. See [Figure 19.2](#) and [Figure 19.3](#).

HCS08 P&E Multilink/Cyclone Pro Connection Connection Procedure

Figure 19.2 HCS08 Connection Assistant Interface Selection

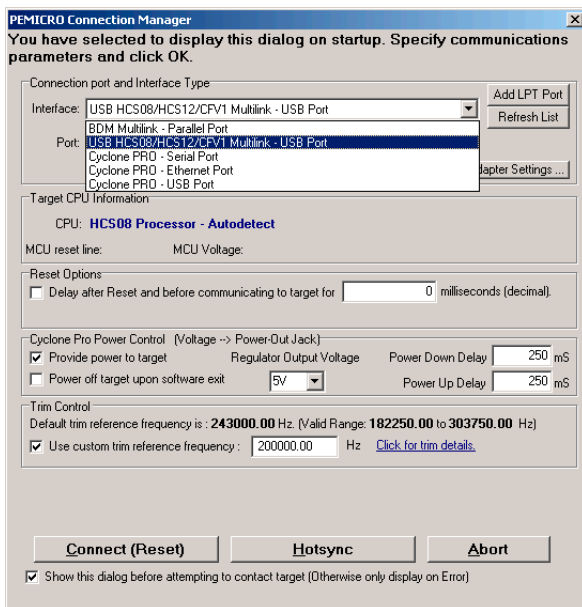
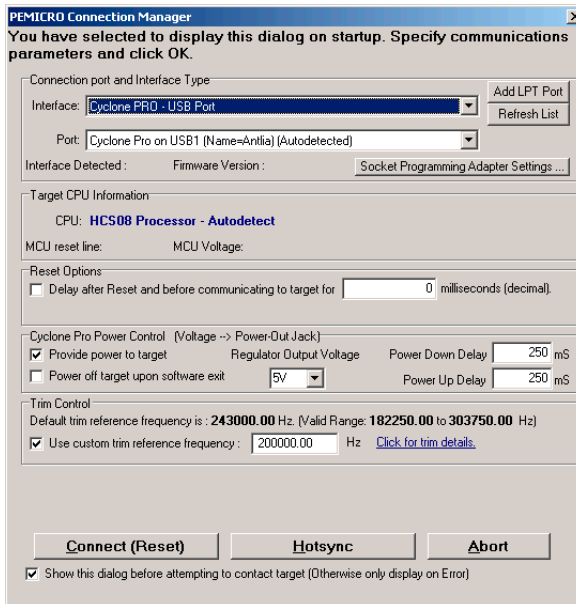

Figure 19.3 HCS08 Connection Assistant Interface Selected



Trim Control

The **Use custom trim reference frequency** option allows the user to select a custom trim value for the target device (valid only for devices with an Internal Clock). The allowable trim value is only limited by the device itself; the user can input any value within the valid internal clock frequency range. Note that the valid internal clock frequency range and the default trim value for the currently selected device/algorithm are displayed as well. For more information about the specific functionality of the internal clock source, see the Freescale Data Sheet for your specific device.

Hotsync Button

The *Hotsync* button in the Connection Assistant (see [Figure 19.3](#)) allows the user to connect to an already running target.

MultilinkCyclonePro Menu Description

When you select P&E Multilink/Cyclone Pro as your connection, the Connection menu's name is changed and other options are added.

Figure 19.4 Connection (MultilinkCyclonePro) Menu

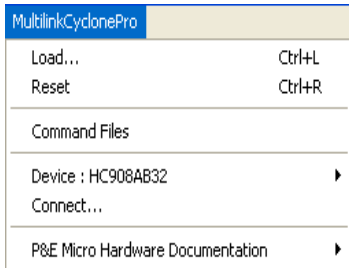

Device Option

The *Device* option in the MultilinkCyclonePro menu allows the user to select the particular Freescale processor that they wish to use. When choosing Device from the MultilinkCyclonePro menu, extended menus open which allow you to select the family (e.g. GB Family), and device type (e.g. 9S0GB60) of the MCU that you are using.

Figure 19.5 HCS08 Device Extended Menu

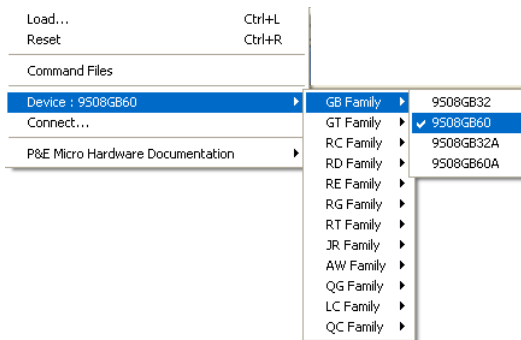

Connect Option

The **Connect** option initiates an attempt to communicate with the device selected under the device section of the menu.

Active Mode Menu Options

When the microprocessor is connected, more Connection menu options become available.

Figure 19.6 Additional Connection Menu Options

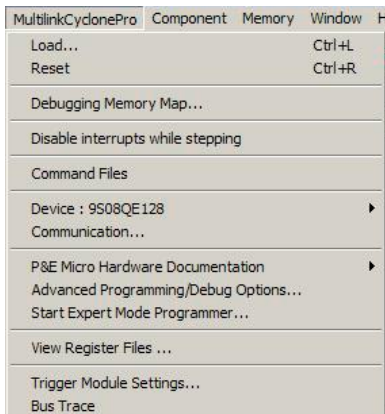

Debugging Memory Map Option

Select **MultilinkCyclonePro > Debugging Memory Map** to display the Debugging Memory Map dialog. For more information about the Debugging Memory Map menu option, see the Debugging Memory Map window.

Disable Interrupts while stepping Option

Select **MultilinkCyclonePro > Disable interrupts while stepping** to debug without diving into the pending program ISRs. Setting this option masks the interrupts before stepping as if you changed the interrupt level in the SR core register directly. When the step occurs, the interrupt level reverts to the previous state, and if necessary, adjusts according to the last executed instruction (when the stepped instruction last affected the interrupt level).

Advanced Programming/Debug Options

The Advanced Programming/Debug Options menu option takes you to the Advanced Options dialog box, where you can configure the software settings for the Flash programming procedure.

HCS08 P&E Multilink/Cyclone Pro Connection Connection Procedure

Figure 19.7 Advanced Options Dialog Box

Prompt on Flash Program Checkbox

Checking **Always Erase and Program Flash without asking** in this dialog box lets the software transparently program the microprocessor.

Trim Options

The **Calculate Trim and Program the Non-Volatile Trim Register** checkbox enables automatic calculation and programming of the trim value in a designated Non-Volatile memory location.

Non-Volatile Memory Preservation

The user is given the option of preserving up to three independent ranges of non-volatile memory (on devices with EEPROM, the entire EEPROM array may optionally be preserved as well). Ranges that are designated as “preserved” are read before an erase, and re-programmed immediately afterwards, thereby preserving the data in these ranges. Any attempts to program data into a preserved range is ignored.

When entering an address into the preserved range field (hexadecimal input is expected), the values are masked according to the row size of the device. This ensures that the reprogramming of preserved data does not cause any program disturb conditions.

Sync to PLL Change Checkbox

Sync to PLL Change is required for the software/hardware connection to synchronize with the microprocessor during the Flash erasing/programming procedure. This option is always enabled for M68HCS08 devices.

Start Expert Mode Programmer Option

The *Start Expert Mode Programmer* option of the Connection Menu grants the user access to P&E's graphical Flash programming utility, PROGHCS08. PROGHCS08 lets an advanced user control the step-by-step execution of the Flash erase/programming procedure. See [Figure 19.8](#). More information on how to use the PROGHCS08 can be found on the P&E Microcomputer Systems website at www.pemicro.com.

Figure 19.8 PROGHCS08 Programmer Window

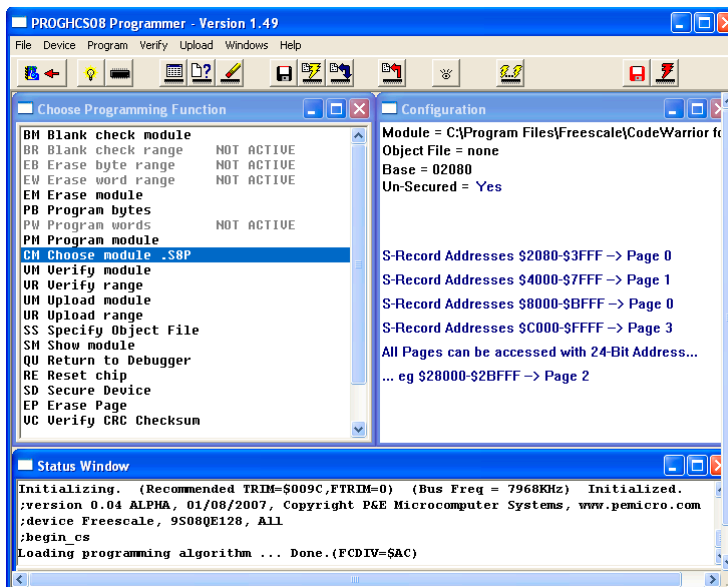

View Register Files Option

The *View Register Files* Connection menu selection also gives the user the option of running the register file viewer/editor. If register files are available for the device that you have chosen, the **Choose a Register Block** window (see [Figure 19.9](#)) opens. You may also open it by entering the R command in the Command Window command line.

HCS08 P&E Multilink/Cyclone Pro Connection

Connection Procedure

Figure 19.9 Choose A Register Block Window

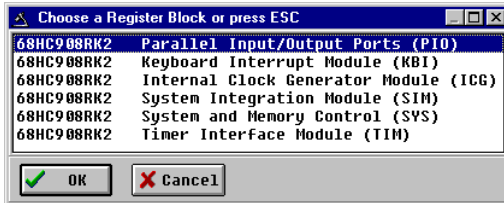

If register files have been installed on the host computer, selecting a block brings up the Register Block register listing (see [Figure 19.10](#)), which shows a list of the associated registers, their addresses, and their descriptions. This begins interactive setup of system registers such as I/O, timer, and COP watchdog.

Figure 19.10 Register Block Register Listing

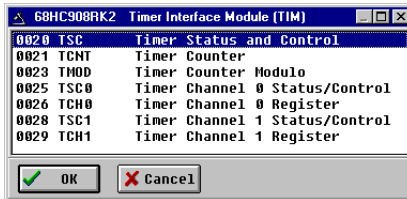

Selecting a file brings up the Register Window (see [Figure 19.11](#)), which displays the values and significance for each bit in the register. The registers can be viewed and their values modified, and the values can be stored back into debugger memory.

Figure 19.11 Register Window

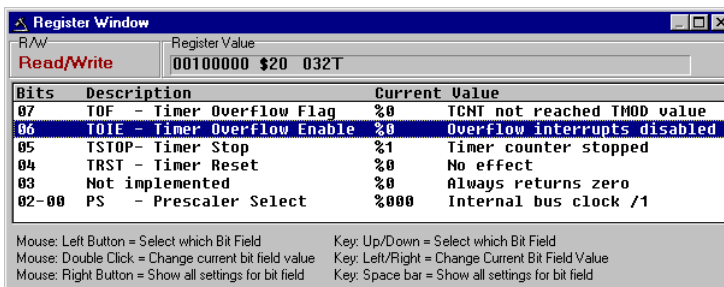

Trigger Module Settings Option

For more information about the *Trigger Module Settings* menu option, see [Trigger Module Settings Window](#).

Bus Trace Option

The *Bus Trace* menu option allows you to gather pertinent bus data by operating the bus analyzer in different modes. The various trace modes let you choose appropriate actions to take when a certain pattern (event), or sequence of patterns, appears on the bus. To trigger the Bus analyzer, define specific bus states as terms, and select a sequence of terms as a trigger event.



HCS08 P&E Multilink/Cyclone Pro Connection *Connection Procedure*

HCS08 Open Source BDM Connection

This chapter guides you through the first steps toward debugging with the CodeWarrior IDE and the *HCS08 Open Source BDM* connection. It does not replace all the additional documentation provided in this manual, but gives you a good starting point.

HCS08 Open Source BDM Technical Considerations

The 8/16 bits debugger (and then the CodeWarrior IDE) can be connected to HCS08 hardware using the HCS08 OSBDM (Open Source BDM) cable.

When the debugger runs the **HCS08 Open Source BDM** connection, it can communicate and debug **HCS08** core-based hardware connected through the *Open Source BDM Interface* as described at the Freescale Semiconductor web site: <http://www.freescale.com> (keyword: OSBDM08).

CodeWarrior IDE and HCS08 Open Source BDM Connection

There are two separate paths that may be followed to take the first steps toward debugging with the CodeWarrior IDE and the HCS08 Open Source BDM connection. The differences between the two paths hinge on the starting point for the steps:

- Using the Stationary Wizard at the start of the project
- From within an existing project

First Steps Using the Stationery Wizard

To take the first steps toward debugging with the CodeWarrior IDE and the HCS08 Open Source BDM using the Stationery Wizard:

1. Run the CodeWarrior IDE.
2. In the *Microcontrollers New Project Wizard*, follow the path to create a new project and name the project.
3. Click the *Next* button to open the New Project window.
4. In the Microcontrollers New Project window, select the HCS08 Family chip that you are working with from the list in the Derivative list box.

Figure 20.1 Microcontrollers New Project Wizard Window

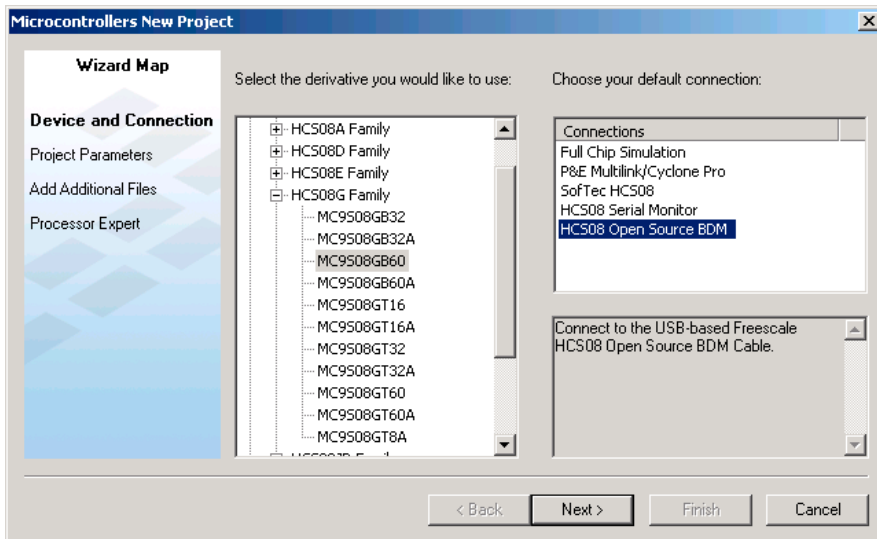

5. From the Default Connection list box, choose the connection **HCS08 Open Source BDM** to create a new project from this stationery.
6. Click the *Finish* button - the CodeWarrior IDE opens.
7. Choose the menu option *Project > Make*.
8. Choose the menu option *Project > Debug* to start the debugger.
9. Start debugging.

First Steps From Within an Existing Project

CAUTION Normally, use the New Project or Change wizard to change the connections. This information is provided for advanced users only.

To take the first steps toward debugging with CodeWarrior IDE and setting the HCS08 Open Source BDM connection from within an existing debugging project:

1. Run the CodeWarrior IDE.
2. Open the project.
3. Choose *Project > Debug* to start the debugger.
4. In the debugger main window, choose *Component > Set Connection* to select another connection.
5. Select **HCS08** as the processor then **HCS08 Open Source BDM** as the connection.

Figure 20.2 Set Connection Dialog Box - HCS08 Open Source BDM Selection

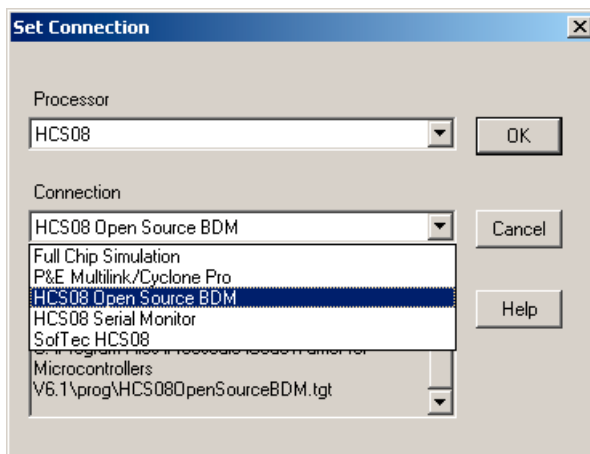

6. Click the OK button - Set Derivative dialog box typically opens (if not, you can start debugging immediately).
7. In the Set Derivative dialog box, select your target processor.

HCS08 Open Source BDM Connection

First Steps From Within an Existing Project

Figure 20.3 MCU Configuration Dialog Box

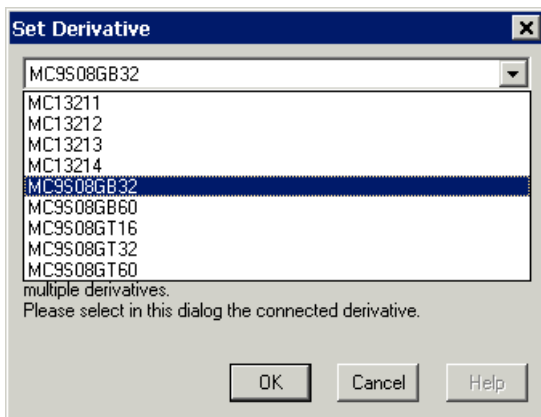

8. Click the OK button to start debugging.

HCS08 Open Source BDM Menu Options

Once the HCS08 Open Source BDM connection is set, the connection menu entry in the debugger main toolbar changes to **HCS08 Open Source BDM**.

Figure 20.4 HCS08 Open Source BDM Menu Options

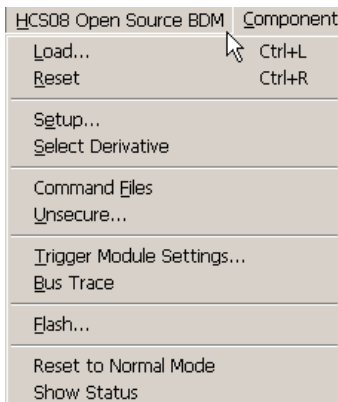

Setup Option

Select *HCS08 Open Source BDM* > *Setup* to display the [HCS08 Open Source BDM Setup Dialog Box](#).

Select Derivative Option

Select *HCS08 Open Source BDM > Select Derivative* to display the [Select Derivative Dialog Box](#).

NOTE If the debugger recognizes only one derivative, this menu entry is not available.

Unsecure Option

Select *HCS08 Open Source BDM > Unsecure* to unsecure the device when necessary. This leads to the [Information Required to Unsecure the Device](#) dialog box.

Trigger Module Settings

Select *HCS08 Open Source BDM > Trigger Module Settings* to open the Trigger Module Settings dialog. For more information see [HCS08 On-Chip DBG Module](#).

Bus Trace

Select *HCS08 Open Source BDM > Bus Trace* to open the Trace component window within the debugger main window. For more information see [HCS08 On-Chip DBG Module](#).

Flash Option

Select *HCS08 Open Source BDM > Flash* to open the Non-Volatile Memory Control dialog box. For more information see [Flash Programming](#).

Reset to Normal Mode Option

Select *HCS08 Open Source BDM > Reset to Normal Mode* to reset the hardware CPU to normal mode.

Show Status Option

Select *HCS08 Open Source BDM > Show Status* to display the [Show Status Dialog Box](#).

HCS08 Open Source BDM Setup Dialog Box

This dialog box is used for setting up communication with a communication device. The Communication Device list menu shows which OSBDM cables are plugged into the computer.

Figure 20.5 HCS08 Open Source BDM Setup Dialog Box

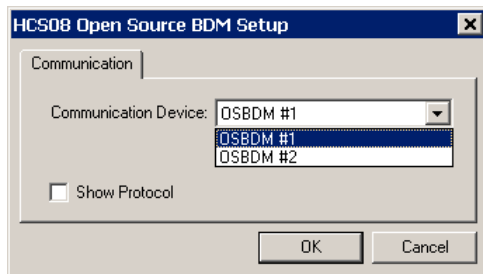

Select the desired cable as your communication device, then click the *OK* button to start debugging.

The Show Protocol checkbox option is only for support usage. Select this checkbox, when you want the debugger's internal information reported in the Command window.

TIP Cables are numbered #1, #2, etc. in the order they have been plugged into the computer USB hub.

Select Derivative Dialog Box

This dialog box is used to set up a derivative. The list menu gives a list of derivatives that match the target silicon System Device Identification Registers (SDIDH, SDIDL).

Figure 20.6 Select Derivative Dialog Box

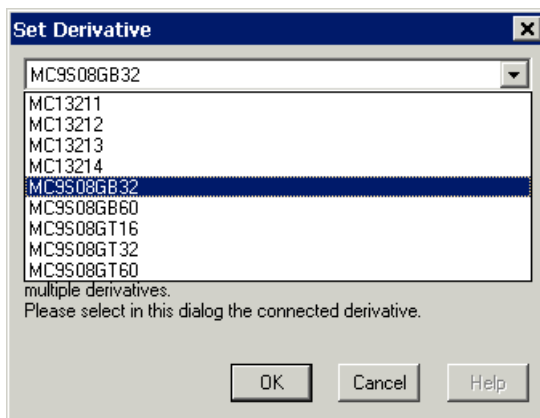

Select your target hardware derivative, then click the *OK* button to start debugging.

Information Required to Unsecure the Device

To unsecure a device, the debugger needs to know the value of the FCDIV register to correctly mass erase the device and program the security byte. The “Information required to unsecure the device” dialog box provides an FCDIV value to the Unsecure Command File script. To access this dialog box, select the menu option *HCS08 Open Source BDM > Command Files* and click on the *Unsecure* tab.

Figure 20.7 Information Required to Unsecure the Device Dialog Box

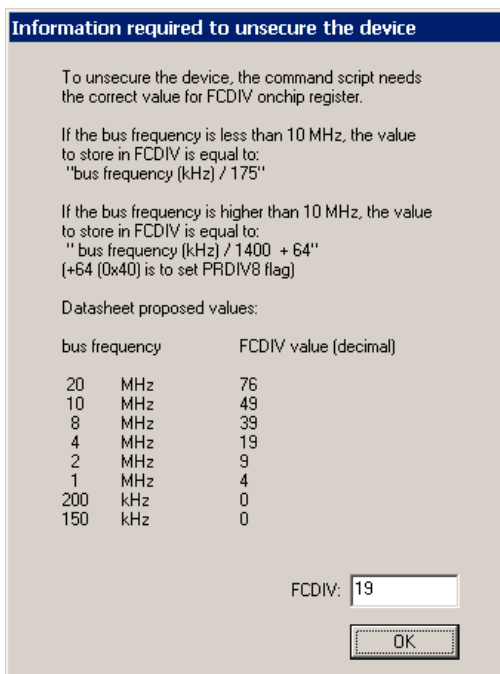

When FCDIV is correctly set, select the *OK* button in this window to run the Unsecure command file script.

Show Status Dialog Box

This dialog box provides both a revision summary of the HCS08 Open Source BDM software and hardware, plus technical support information.

Figure 20.8 Show Status Dialog Box

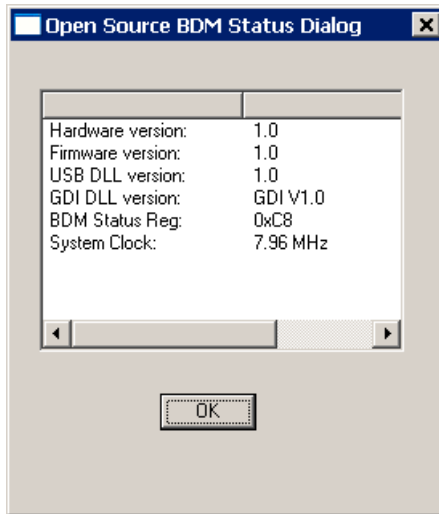

Press the *OK* button to close this dialog box.



HCS08 Open Source BDM Connection

First Steps From Within an Existing Project

HCS08 Serial Monitor Connection

This section guides you through the first steps toward debugging with the CodeWarrior IDE and the *HCS08 Serial Monitor* connection. It does not replace all the additional documentation provided in this manual, but gives you a good start.

Serial Monitor Technical Considerations

The 8/16 bit debugger (and then the CodeWarrior IDE) can be connected to HCS08 hardware using the HCS08 Serial Monitor connection. This connection supports communication specifications described in the *Serial Monitor for MC9S08GB/GT Application Note AN2140/D* from Freescale.

When the debugger runs the HCS08 Serial Monitor connection, it can communicate and debug hardware running the HCS08 Serial Monitor in full compliance with the Freescale *Serial Monitor for MC9S08GB/GT Application Note AN2140/D* specifications. Refer to this Application Note for communication hardware requirements.

CodeWarrior IDE and Serial Monitor Connection

There are two separate paths that may be followed to take the first steps toward debugging with the CodeWarrior IDE and the HCS08 Serial Monitor connection. The differences between the two paths hinge on the starting point for the steps:

- Using the Stationary Wizard at the start of the project
- From within an existing project

First Steps Using the Stationery Wizard

To take the first steps toward debugging with CodeWarrior IDE and the HCS08 Serial Monitor connection:

1. Run the CodeWarrior IDE with the shortcut created in the program group.
2. In the *Microcontrollers New Project Wizard*, follow the path to create a new project, naming the project.
3. Click the *Next* button to open the New Project window.
4. In the *Microcontrollers New Project* window, select the HCS08 Family chip you are working with from the list in the Derivative list box.

Figure 21.1 Microcontrollers New Project Wizard Window

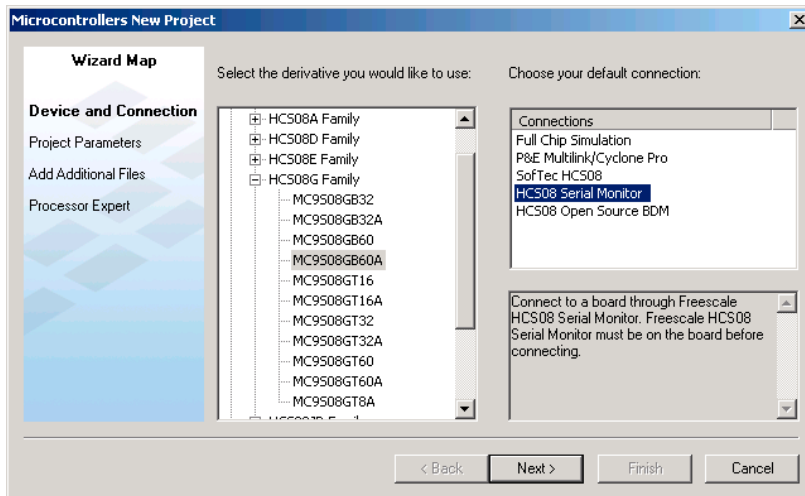

5. From the Default Connection list box, choose the connection **HCS08 Serial Monitor** to create a new project from this stationery.
6. Click the *Finish* button - the IDE opens.
7. Choose the menu option *Project > Make*.
8. Choose the menu option *Project > Debug* to start the debugger.
9. Start debugging.

First Steps from Within an Existing Project

To take the first steps toward debugging with CodeWarrior IDE and setting the HCS08 Serial Monitor connection from within an existing debugging project:

1. Run the CodeWarrior IDE with the shortcut created in the program group.
2. Open the existing project.
3. Choose the menu *Project > Debug* to start the debugger - debugger main window opens.
4. In the debugger main window, from the Component menu, choose *Component > Set Connection* to select another connection.

Figure 21.2 Set Connection Dialog Box - HCS08 Serial Monitor Selection

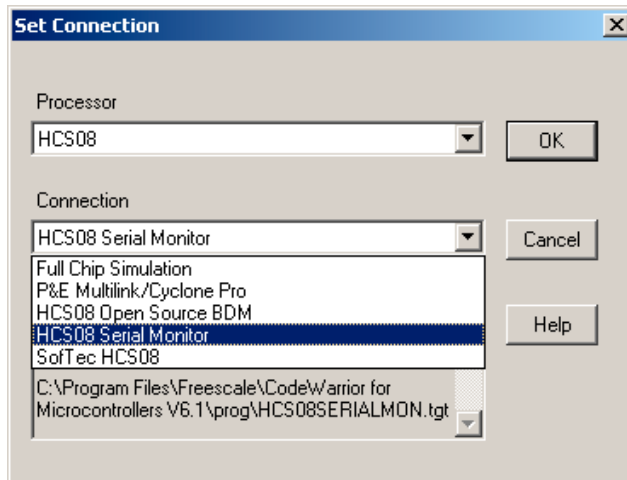

5. Select **HCS08** as the Processor then **HCS08 Serial Monitor** as the connection in the Set Connection dialog box.
6. Click the *OK* button.
7. Now in the Monitor Setup window, Monitor Communication tab, choose the correct Host serial communication port if necessary.

HCS08 Serial Monitor Connection

First Steps from Within an Existing Project

Figure 21.3 Monitor Setup Window - Monitor Communication Tab

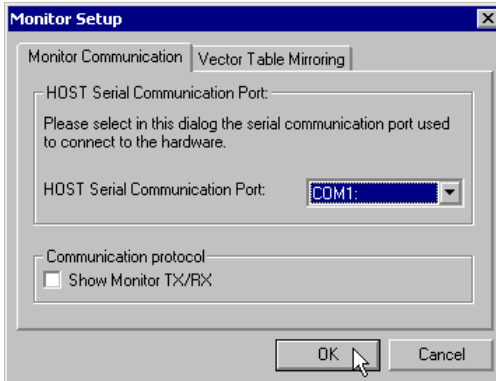

8. Press the *OK* button. The HCS08 Serial Monitor connection reads the device silicon ID. This ID can match several derivatives.
9. Set the correct derivative matching your hardware in the Derivative Selection dialog box.

Figure 21.4 Derivative Selection Dialog Box

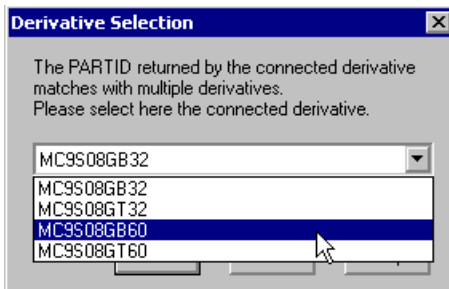

10. Press the *OK* button. The **Monitor Setup** window is opened again, to propose to use the “mirrored vector table” feature. See **Vector Redirection** in the *Serial Monitor for MC9S08GB/GT Application Note AN2140/D* for all details. We recommend that you use the Vector Table Mirroring feature. Otherwise, vectors cannot be programmed as captured and protected from erasing or overwriting by the HCS08 Serial Monitor.

Figure 21.5 Monitor Setup Window - Vector Table Mirroring Tab

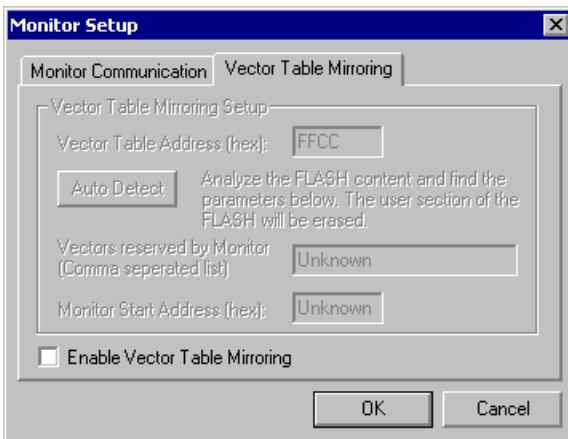

11. To enable this feature, check the Enable Vector Table Mirroring checkbox.

Figure 21.6 Monitor Setup Window - Vector Table Mirroring Tab

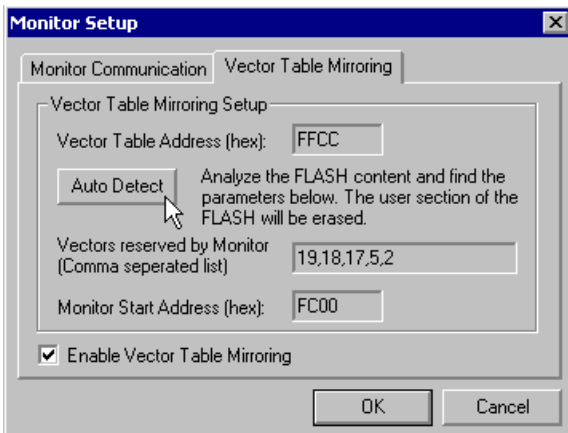

12. Press the *Auto Detect* button to make the debugger search for the vector table address and vectors reserved by the HCS08 Serial Monitor.

13. Once the auto detection succeeds, press the *OK* button to start debugging.

MONITOR-HCS08 Menu Options

Once the *HCS08 Serial Monitor* connection is set, the MONITOR-HCS08 menu entry is set in the Debugger menu.

Figure 21.7 MONITOR-HCS08 Menu Entries



Monitor Communication

Select the *MONITOR-HCS08 > Monitor Communications* option to display the [Monitor Setup Window - Monitor Communication Tab](#).

Vector Mirroring Setup

Select the *MONITOR-HCS08 > Vector Mirroring Setup* option to display the [Monitor Setup Window - Vector Table Mirroring Tab](#).

Erase Flash

Select the *MONITOR-HCS08 > Erase Flash* option to immediately erase the target processor Flash.

Trigger Module Settings

Select the *MONITOR-HCS08 > Trigger Module Settings* option to open the **Trigger Module Settings** dialog box. Refer to the *Debugger HCS08 On-chip DBG Module User Interface manual* for all related information.

Bus Trace

Select the *MONITOR-HCS08 > Bus Trace* option to open the Trace component window within the debugger main window. Refer to the *Debugger HCS08 On-chip DBG Module User Interface* manual for all related information.

Select Derivative

Select the *MONITOR-HCS08 > Select Derivative* option to open the [Derivative Selection Dialog Box](#).

Monitor Setup Window

The Monitor Setup window has two tabs, as shown in [Monitor Setup Window - Monitor Communication Tab](#) and [Monitor Setup Window - Vector Table Mirroring Tab](#).

Figure 21.8 Monitor Setup Window - Monitor Communication Tab

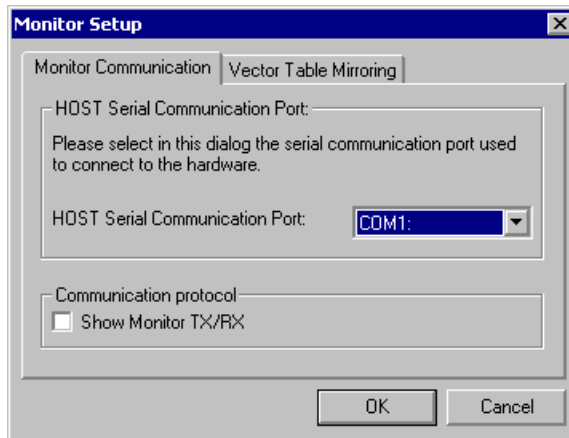

Monitor Communication Tab

In the Monitor Communication tab, you can set or modify the current serial communication port in the HOST Serial Communication Port list menu.

Check the *Show Monitor TX/RX* checkbox to report all low level communication frames between the host computer and the HCS08 Serial Monitor, in the debugger Command Line window.

HCS08 Serial Monitor Connection

First Steps from Within an Existing Project

Figure 21.9 Monitor Setup Window - Vector Table Mirroring Tab

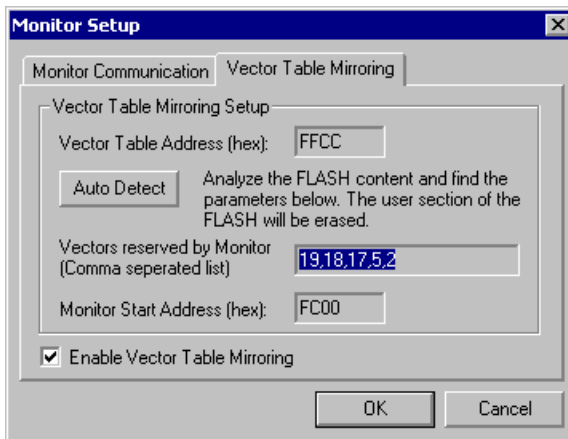

Vector Table Mirroring Tab

Using the Vector Table Mirroring tab, it is possible to set the “Vector Table Mirroring” feature. See the *Vector Redirection* section of Freescale *Serial Monitor for MC9S08GB/GT Application Note AN2140/D* for all details.

The HCS08 Monitor start address is given in the *Monitor Start Address* edit box.

The real vector table address is given in the *Vector Table Address* edit box.

The list of vectors reserved by the HCS08 Serial Monitor is given in the *Vectors reserved by Monitor* edit box.

NOTE In the Vectors reserved by Monitor list box above, the number “1” matches the **RESET** vector, “2” is the **SWI** vector, “5” is the **ICG** vector, etc.

Vector table mirroring allows you to access chip vectors transparently. Indeed, the HCS08 Serial Monitor also uses some vectors, and the vector area is protected from erasing and overwriting. We recommend that you use this feature. Otherwise, user application vectors cannot be programmed as captured and are not protected from erasing/overwriting by the HCS08 Serial Monitor.

To enable this feature, check the Enable Vector Table Mirroring checkbox, then press the Auto Detect button to make the debugger search for the vector table address and vectors reserved by the HCS08 Serial Monitor. Once auto detection has succeeded, you can press the OK button to save and quit this window.

Derivative Selection Dialog Box

Within this dialog box, it is possible to select a specific derivative according to the *System Device Identification Register* (SDIDH, SDIDL) (sometimes called PARTID) returned by the silicon device.

Figure 21.10 Derivative Selection Dialog Box

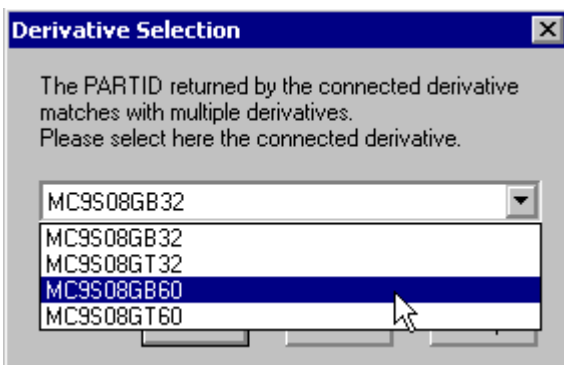

As several silicon devices might return the same value, a selection list is available to select the debugged derivative; according to reference text written on the top of the silicon.



HCS08 Serial Monitor Connection

First Steps from Within an Existing Project

SofTec HCS08 Connection

This chapter guides you through the first steps toward debugging with the CodeWarrior IDE and the *SofTec HCS08* connection. It does not replace all the additional documentation provided in this manual, but gives you a good starting point.

SofTec HCS08 Technical Considerations

The 8/16 bit debugger (and then the CodeWarrior IDE) can be connected to HCS08 hardware using the SofTec HCS08.

When the debugger runs the **SofTec HCS08** connection, it can communicate and debug **HCS08** core-based hardware connected through the SofTec in-circuit debugger/ programmer units, that is:

SofTec Microsystems HCS08 ISP Debuggers/Programmers (inDART Series) and Starter Kits (PK and newer Series).

Refer to the *inDART®-HCS08 In-Circuit Debugger/Programmer for Motorola HCS08 Family FLASH Devices User's Manual* from SofTec for communication hardware requirements and SofTec product installation.

CodeWarrior IDE and SofTec HCS08 Connection

There are two separate paths that may be followed to take the first steps toward debugging with the CodeWarrior IDE and the SofTec inDART-HCS08 connection. The differences between the two paths hinge on the starting point for the steps:

- Using the Stationary Wizard at the start of the project
- From within an existing project

First Steps Using the Stationery Wizard

To take the first steps toward debugging with the CodeWarrior IDE and the SofTec inDART-HCS08 using the stationery Wizard:

1. Run the CodeWarrior IDE with the shortcut created in the program group.
2. In the *Microcontrollers New Project Wizard*, follow the path to create a new project, naming the project.
3. Click the *Next* button to open the New Project window.
4. In the *Microcontrollers New Project* window, choose HCS08 Family chip you are working with from the list in the Derivative list box.

Figure 22.1 Wizard Connection Selection

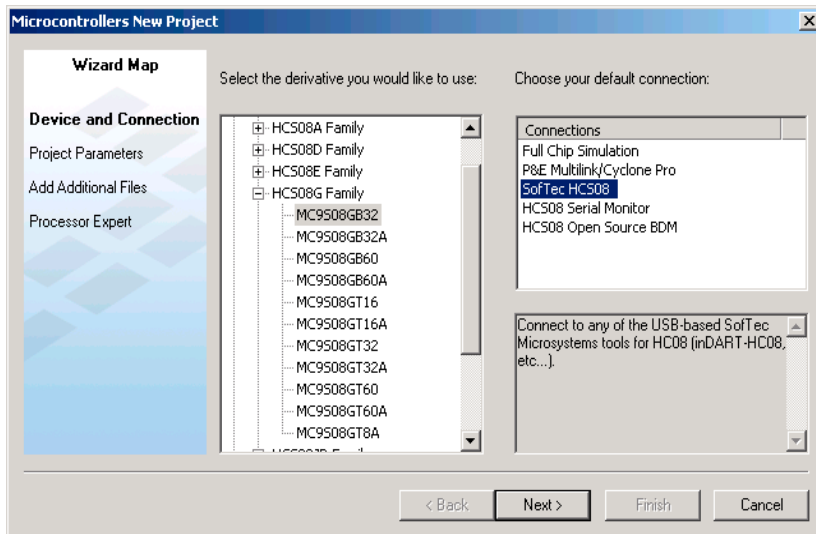

5. From the Default Connection list box, choose the connection **SofTec HCS08** to create a new project from this stationery.
6. Click the *Finish* button - the CodeWarrior IDE opens.
7. Choose the menu option *Project > Make*.
8. Choose the menu option *Project > Debug* to start the debugger.
9. Start debugging.

First Steps from Within an Existing Project

To take the first steps toward debugging with the CodeWarrior IDE and setting the SofTec HCS08 connection from within an existing debugging project:

1. Run the CodeWarrior IDE with the shortcut created in the program group.
2. Open the project.
3. Choose *Project > Debug* to start the debugger.
4. In the debugger choose *Component > Set Connection* to select another target interface in the Set Connection dialog box.
5. Select **HCS08** as the Processor then **SofTec HCS08** as the connection.

Figure 22.2 Set Connection Dialog Box - SofTec HCS08 Selection

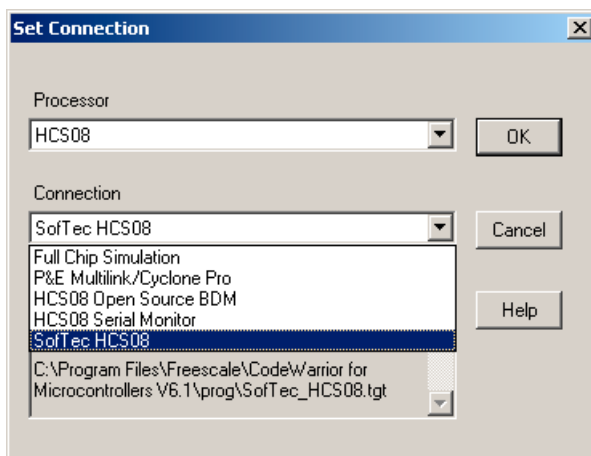

6. Press the OK button - MCU Configuration dialog box opens.
7. In the MCU Configuration dialog box, choose the correct target processor.

SofTec HCS08 Connection

First Steps from Within an Existing Project

Figure 22.3 MCU Configuration Dialog Box

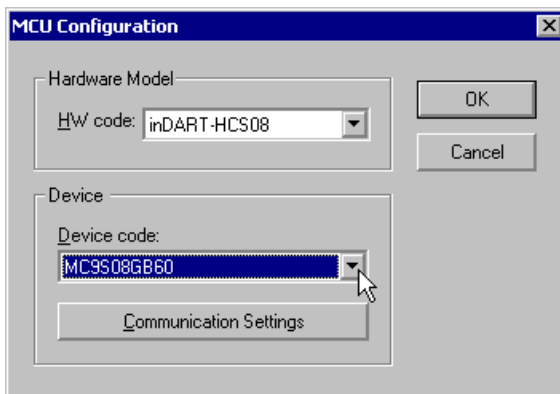

8. Press the *OK* button to start debugging.

SofTec HCS08 Menu Options

Once the SofTec HCS08 connection is set, the connection menu entry in the debugger main toolbar changes to **SofTec-HCS08**.

Figure 22.4 SofTec-HCS08 Menu Options

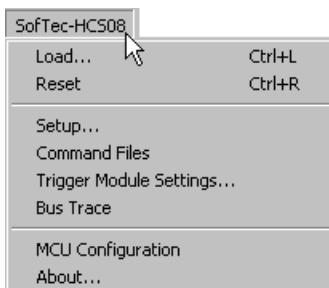

MCU Configuration Option

Select *SofTec-HCS08* > *MCU Configuration* to display the [MCU Configuration Dialog Box](#).

About Option

Select *SofTec-HCS08* > *About* to display the [About Dialog Box](#).

Trigger Module Settings

Select *SofTec-HCS08 > Trigger Module Settings* to open the **Trigger Module Settings** dialog box. Refer to the *Debugger HCS08 Onchip DBG Module User Interface manual* for related information.

Bus Trace

Select *SofTec-HCS08 > Bus Trace* to open the Trace component window within the debugger main window. Refer to the [HCS08 On-Chip DBG Module](#) section for related information.

MCU Configuration Dialog Box

The Hardware Model drop down list can be expanded to select another type of BDC debug interface than the SofTec inDART-HCS08. The HW Code drop down list can be expanded to select another HCS08 derivative.

Figure 22.5 MCU Configuration Dialog Box

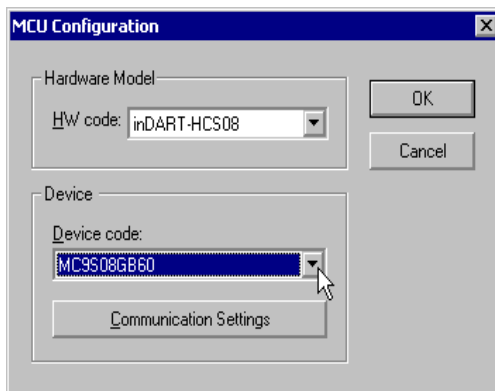

Press the *Communication Settings* button in this window to open the [Communication Settings Dialog Box](#).

Communication Settings Dialog Box

The BDC Clock (CLKSW) group is intended to setup the best BDC synchronization between the SofTec inDART-HCS08 interface and the target processor.

When **Use system bus frequency** is selected, the BDC communication clock source is the microcontroller's bus frequency; when **Use alternate frequency** is selected, the BDC communication clock source is a constant clock source, which can vary depending on the

SofTec HCS08 Connection

First Steps from Within an Existing Project

specific HCS08 derivative. In the case of the MC9S08GB60, for example, this constant clock source is an 8 MHz internal clock. Other derivatives may use the external crystal frequency.

Refer to the *inDART®-HCS08 In-Circuit Debugger/Programmer for Motorola HCS08 Family FLASH Devices User's Manual* from SofTec for further details.

Figure 22.6 Communication Settings Dialog Box

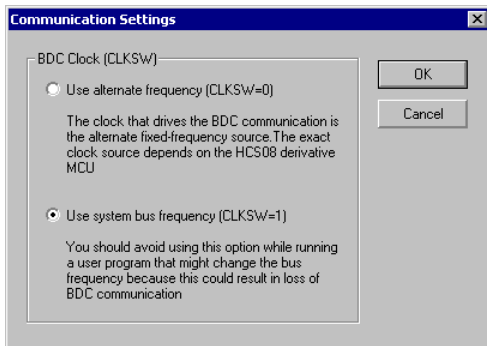

About Dialog Box

This dialog box belongs to the SofTec GDI DLL and provides information about the SofTec_BDC08.dll release and version.

Figure 22.7 About Dialog Box



HCS08 On-Chip DBG Module

The HCS08 derivatives featuring an on-chip DBG module require a debugger graphical user interface to setup this module and take full advantage of this enhanced debugging feature. This chapter describes the debugger DBG module user interface.

Within several HCS08 debugger connections (e.g. P&E Debug), the HCS08 Serial Monitor and inDART-HCS08, a complete graphical user interface is provided. A trigger setup dialog box and context sensitive context menus (right-click) in the Source, Assembly, Data and Memory component windows are used to set the on-chip DBG module and triggers.

This DBG module support is automatically enabled or disabled, according to derivative selected by user or automatically through the device Part Id.

Reference Document

The HCS08 on-chip DBG module described in this chapter is also described in the *HCS08RMv1/D, Rev. 1, 6/2003* Freescale document.

DBG Features

The debugger covers all features available within the on-chip DBG module:

- Regular hardware breakpoints and watchpoints
- Predefined preset [Instruction Triggers](#), [Memory Access Triggers](#) or [Capture Triggers](#), a wide set of complex hardware breakpoints (triggers on program code instructions) and watchpoints (triggers on device memory access) and data bus recording
- Expert Triggers, as powerful as predefined preset triggers
- Code program flow rebuild from DBG data capture within the Trace window component (open the Trace component to display the code program flow rebuild).

HCS08 On-Chip DBG Module

Specific Connection Menu Options

- Real time program code profiling and coverage within the Profiler and Coverage window components (open the Profiler and/or the Coverage components to display code profiling and code coverage).

Specific Connection Menu Options

Specific DBG support menu options are added to the Connection menu as soon as the debugger target processor is acknowledged by the DBG module. Two additional context menu entries are displayed: **Trigger Module Settings** and **Bus Trace**. Shown below is an example with the P&E (PEDebug) connection.

Figure 23.1 Connection Menu - Added DBG Options

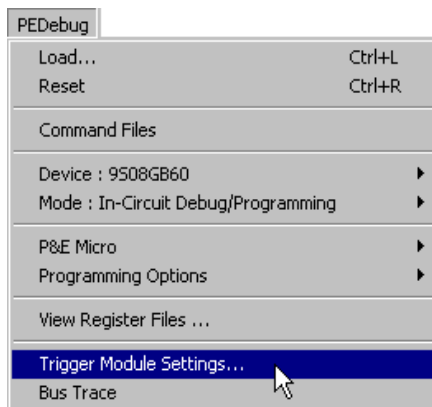

Choose **Trigger Module Settings** to open the [Trigger Module Settings Window](#).

Choose **Bus Trace** to open the [Trace Component Window](#).

Context Menu Entries in Source, Data, Assembly and Memory Windows

Specific DBG support menu options are added to the Connection menu as soon as the debugger target processor is acknowledged by the DBG module.

Source and Assembly Windows

Source and Assembly windows have menu entries to set/delete [Instruction Triggers A](#) and/or B, a [Trigger Settings](#) to set the DBG module Triggers Settings and the [Trigger Module Usage](#) to set the DBG module functionality globally.

Setting a trigger, which can be assimilated as a complex breakpoint or watchpoint, is as simple as setting a breakpoint.

Figure 23.2 Source Context Menu - Added Options

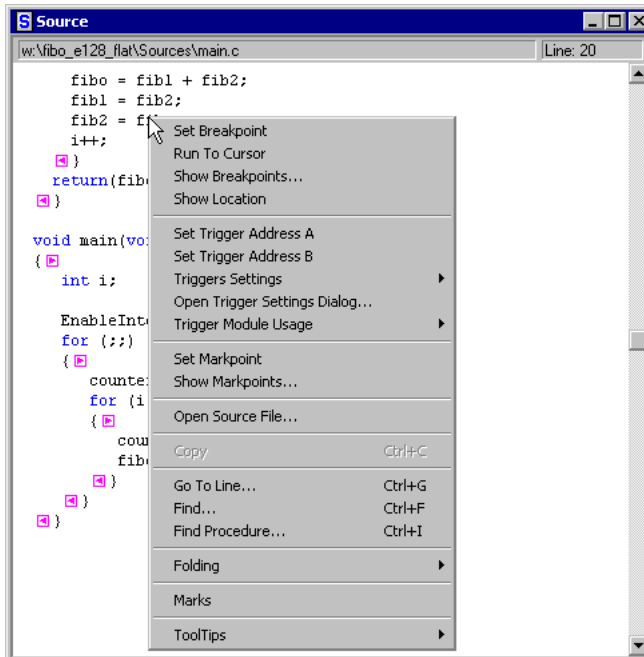

Instead of setting a breakpoint, a trigger can be set. Note that only 2 triggers can be set: **Trigger A** and **Trigger B**. In a general way, the on-chip DBG module provides combinations of trigger A and trigger B conditions, and according to the number of triggers defined (one or two), different triggers [DBG Module Mode Setup](#) can be chosen.

HCS08 On-Chip DBG Module

Context Menu Entries in Source, Data, Assembly and Memory Windows

To set a trigger, select a **Set Trigger Address** entry at the selected source location/ address.

Figure 23.3 Set Trigger Address A Option

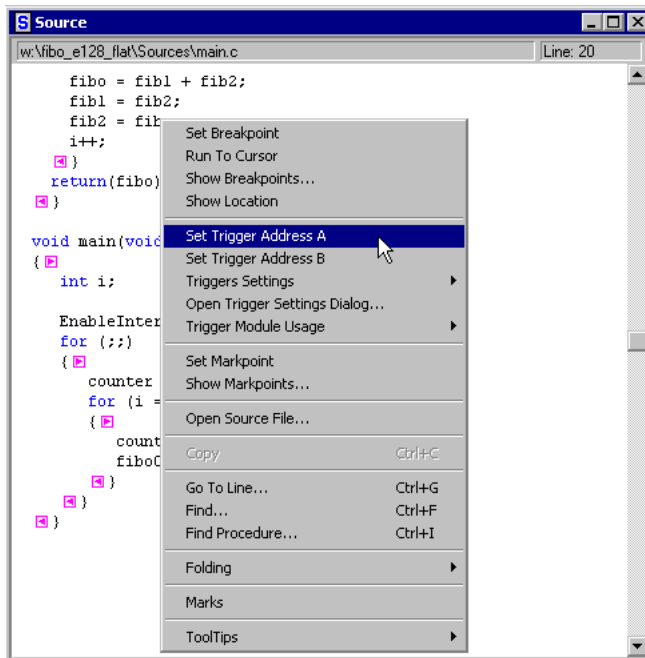

The trigger is displayed in the Source window and at the corresponding address in the Assembly window, just like a breakpoint icon. To distinguish from breakpoints, trigger A is marked with a red **A** icon and trigger B with a red **B** icon.

Figure 23.4 Triggers Set in Source and Assembly Windows

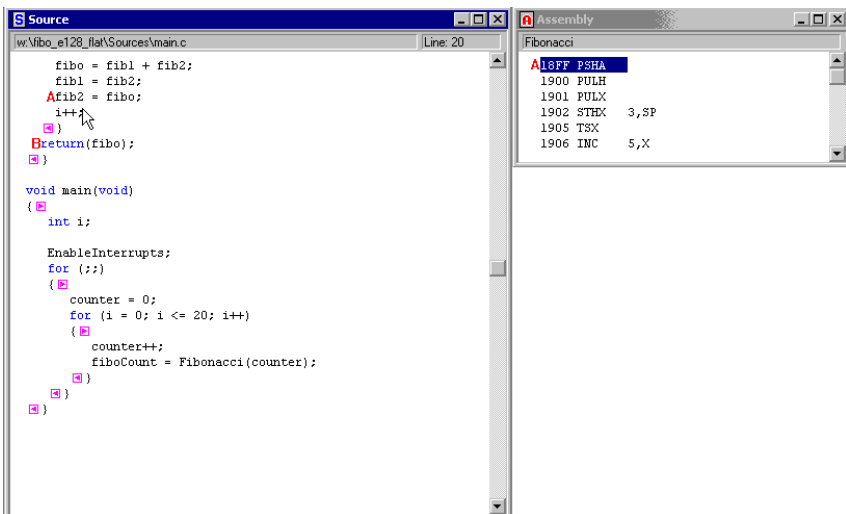

Once a trigger is set, it can be deleted by opening any context sensitive menu that contains the **Delete Trigger Address** option.

Trigger Stored as Markpoints

Triggers are stored in the debugger as special markpoints. Like breakpoints, markpoints can be viewed by choosing *Show Markpoints* in the menu.

Triggers are stored as **Trigger A** and **Trigger B** markpoints. These markpoint names are therefore reserved by the debugger. The markpoint type **INSTRUCTION** is automatically selected when the trigger is set from the Source or Assembly window.

Figure 23.5 Show Markpoints Option

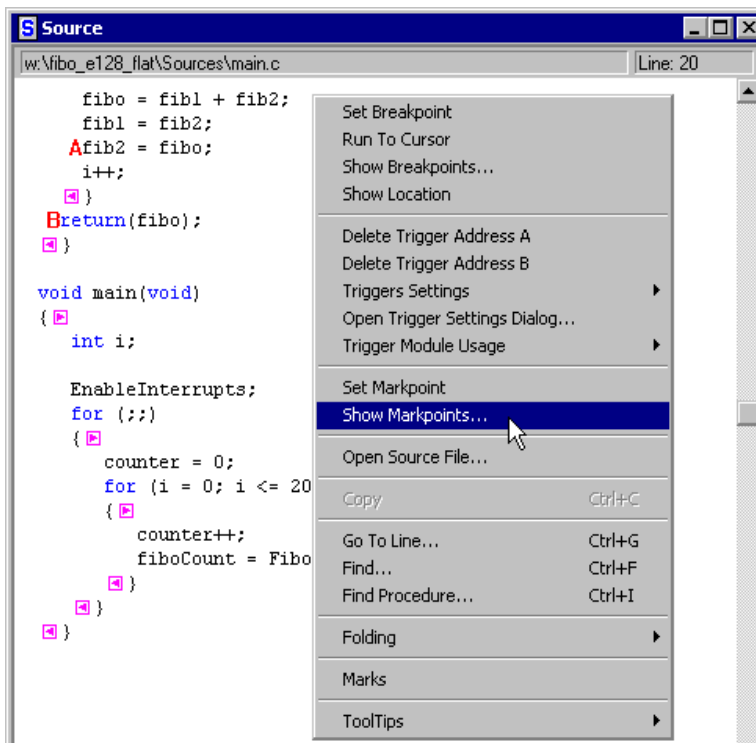

Selecting the Show Markpoints option from the Source window causes the **Controlpoints Configuration** window to open with its **Markpoints** tab displayed.

Figure 23.6 Controlpoints Configuration Window - Markpoints Tab

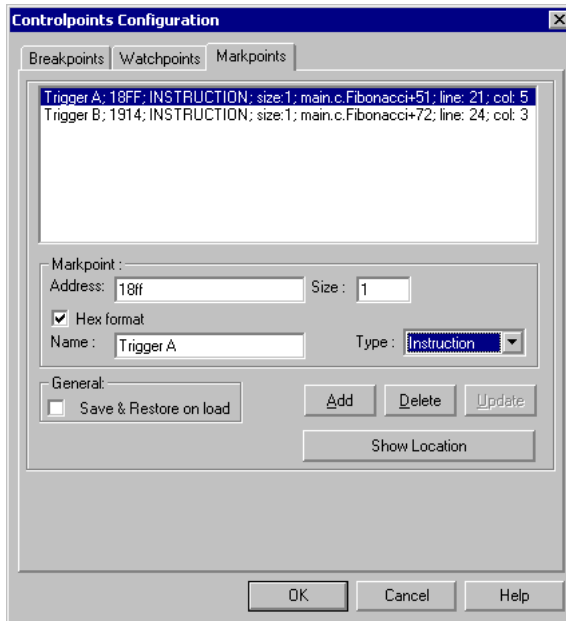

Editing triggers through the **Markpoints** tab in the **Controlpoints Configuration** window below is not user friendly. However, the *Save and Restore on load* option (also available with breakpoints and watchpoints) can be very useful to automatically save the application with the DBG module setup and trigger positions saved as they are set in the current application.

Data and Memory Windows

Data and Memory windows have context menu options to set/delete [Memory Access Triggers](#) A and/or B, a [Trigger Settings](#) option to set the DBG module triggers settings and the [Trigger Module Usage](#) option to globally set the DBG module functionality.

Setting a trigger, which can be assimilated as a complex breakpoint or watchpoint, is as simple as setting a watchpoint.

HCS08 On-Chip DBG Module

Context Menu Entries in Source, Data, Assembly and Memory Windows

Figure 23.7 Data Window Context Menu - Set Trigger A Option

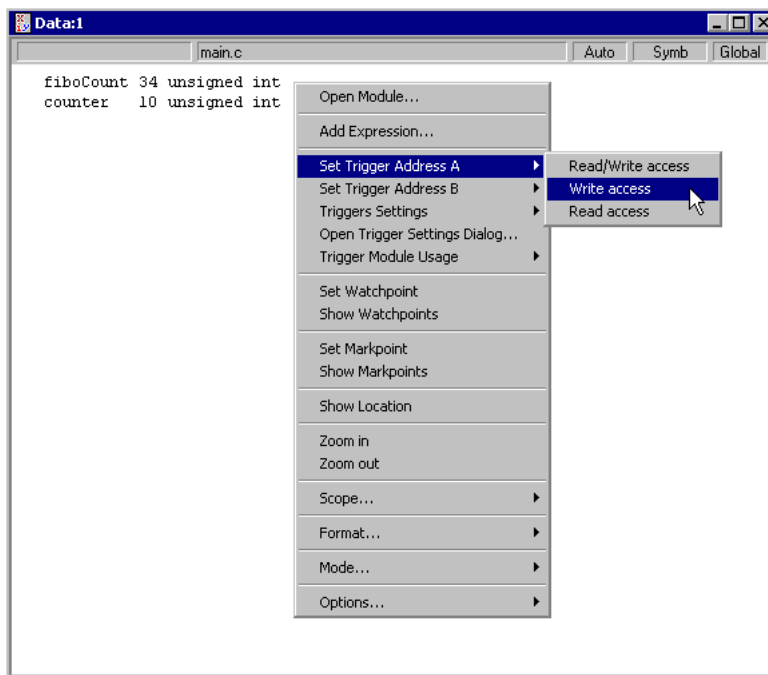

In the Data window, instead of setting a watchpoint, a trigger can be set. Note that only 2 triggers can be set: Trigger A and trigger B. In a general way, the on-chip DBG module provides combinations of trigger A and trigger B conditions, and according to the number of triggers defined (one or two), a different trigger [DBG Module Mode Setup](#) can be chosen.

To set a trigger, choose a *Set Trigger Address* entry and the kind of access - **Read**, **Write**, **Read/Write**. This sets a trigger at the selected place.

Figure 23.8 Triggers Set in Data and Memory Windows

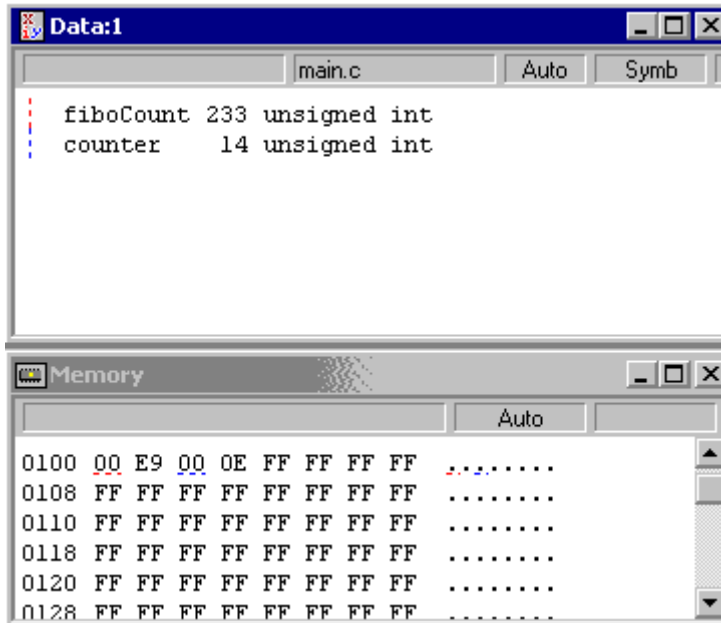

The trigger is displayed in the Data window and at the corresponding address in the Memory window like a watchpoint icon. To be distinguished from watchpoints, the trigger A is marked with a red dotted vertical line and trigger B with a blue dotted vertical line.

Expert Triggers

The [Expert Mode](#) has a different set of triggers and trigger designs. Indeed, to completely separate the Expert mode from the Automatic mode, the debugger provides a second set of triggers for the Expert mode. [Expert Triggers](#) are independent from the regular triggers described previously.

Context sensitive context menu entries are slightly different, basically replacing the *Set Trigger Address A* entry by a *Set DBGCA* entry and the *Set Trigger Address B* entry by a *Set DBGCB* entry. The renaming is due to a more physical DBG registers approach in Expert mode and in the [Expert Mode Tab](#).

Figure 23.9 Source Window Context Menu - Expert Trigger Options



As shown in the next picture, Expert triggers are displayed in Source and Assembly windows with a small additional “e” character and different colors in the Memory component.

NOTE When the Expert mode is set, preset [Instruction Triggers](#), [Memory Access Triggers](#) or [Capture Triggers](#) designs are grayed out. When the automatic mode is set or a predefined preset trigger is set, the Expert mode trigger designs are grayed out.

Figure 23.10 Expert Triggers in Source, Assembly, Memory and Data Windows

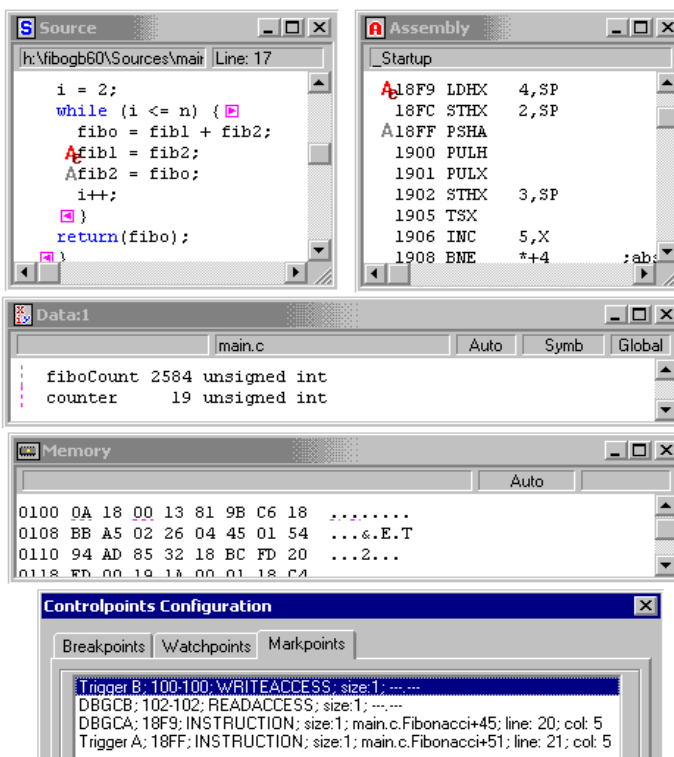

As shown above, expert triggers are stored in the Markpoints tab of the Controlpoints Configuration window as **DBGCA** and **DBGCB** markpoints. These markpoint names are therefore reserved by the debugger.

The markpoint type **INSTRUCTION** is automatically selected when the trigger was set from the Source or the Assembly window.

As for regular triggers, the markpoint types **READACCESS**, **WRITEACCESS** or **READWRITEACCESS** are automatically selected when the trigger was set from the Data or the Memory window.

Just as with regular triggers, editing expert triggers through the **Markpoints** tab in the **Controlpoints Configuration** window is not user friendly. However, the *Save and Restore on load* option (also available with breakpoints and watchpoints) can be very useful to automatically save the application with the current DBG module setup and trigger positions just as they were used in the application.

Trigger Settings

The Trigger Settings option of a context menu can be chosen to set all kinds of triggers without opening the [Trigger Module Settings Window](#). However, the amount of trigger types is **dynamic**, depending if no triggers are defined, if only Trigger A is defined, if only trigger B is defined if both triggers are defined, and also depending on the trigger type (Instruction, Read Access, Read/Write Access, Write Access. **Only possible combinations are displayed.**

Also [DBG Module Options](#) can be directly edited.

Figure 23.11 Triggers Setting Menu Option - Extended Menu

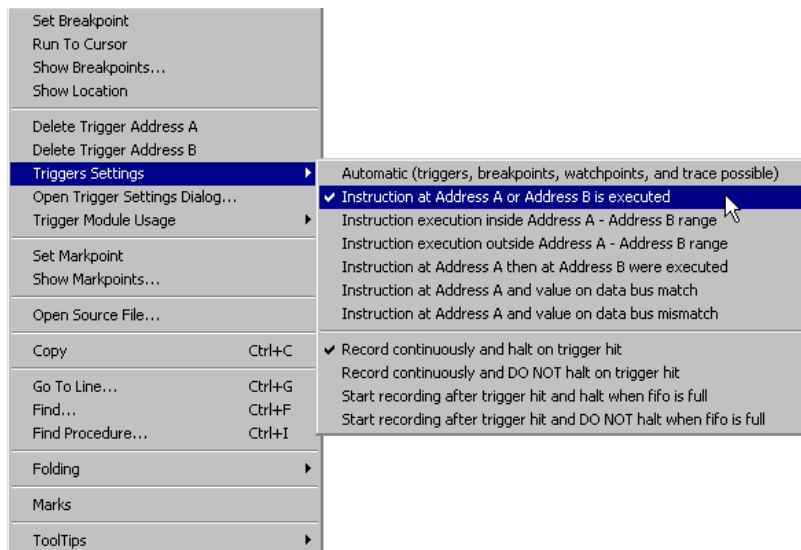

Trigger Module Usage

This menu entry can be used to globally set the DBG module functionality without opening the [Trigger Module Settings Window](#) to do the [DBG Module Mode Setup](#).

Figure 23.12 Source Window Extended Menu

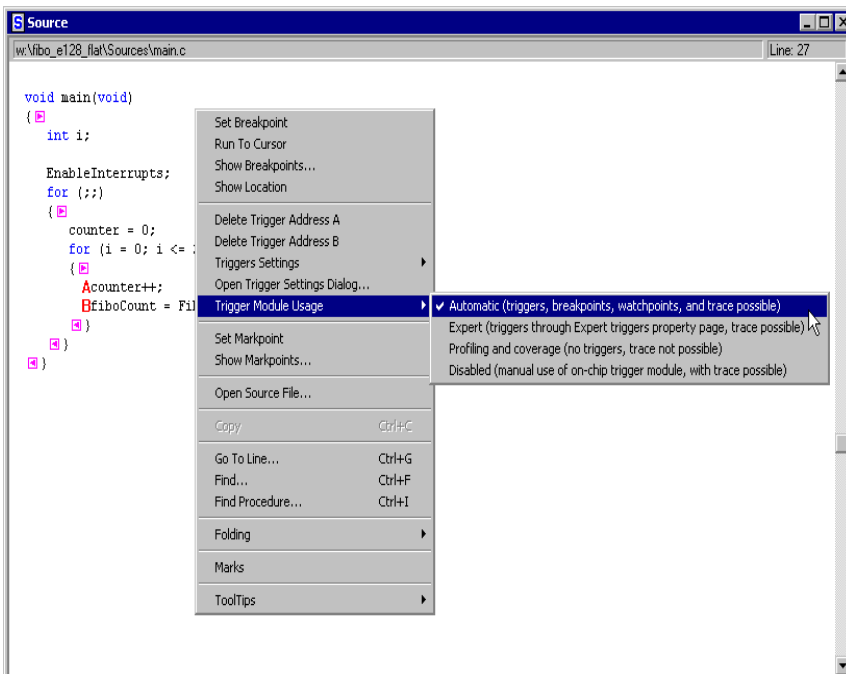

DBG Support Status Bar Item

A specific DBG support debugger status bar item is present as soon as the debugger target processor features the DBG module. Clicking on this item opens immediately the [Trigger Module Settings Window](#) (future debugger revision only).

Figure 23.13 Status Bar Item



HCS08 On-Chip DBG Module

Trigger Module Settings Window

The status bar displays the current [DBG Module Mode Setup](#) (as shown above) or the current preset [Instruction Triggers](#), [Memory Access Triggers](#) or [Capture Triggers](#) used or the current [DBG Module Mode Setup](#).

Figure 23.14 Status Bar Item

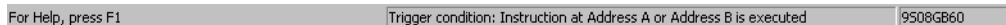

Trigger Module Settings Window

This window can be opened from context sensitive context menus in the Source, Data, Memory and Assembly component windows, from the Connection menu and also when clicking on a Status Bar item.

The on-chip DBG module can be fully controlled from within this window.

Figure 23.15 Trigger Module Settings Window - Trigger Settings Tab

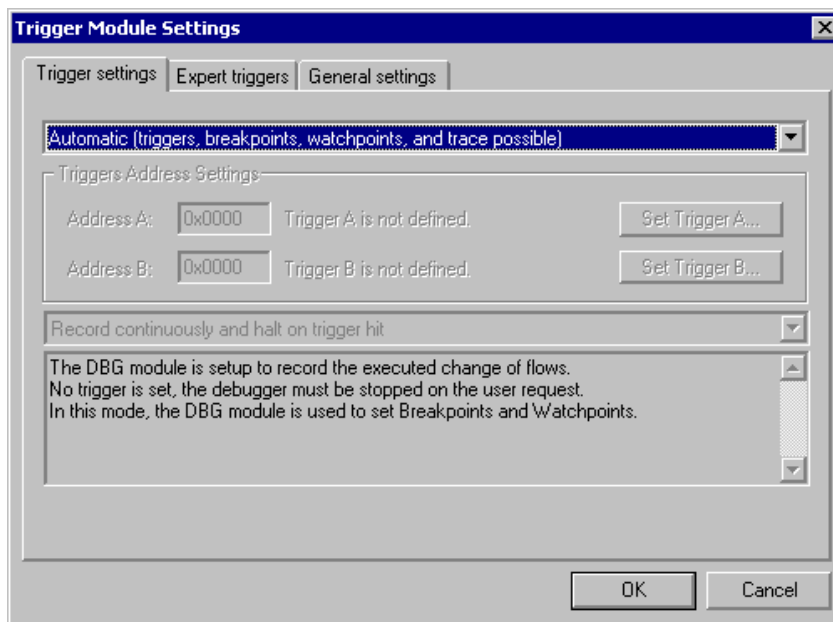

DBG Module Mode Setup

First of all, the on-chip DBG module provides some exclusive debugging features. Open the top list menu to display all modes and complex breakpoints/watchpoints, that is, kind of triggers available.

Figure 23.16 Trigger Settings Tab Listbox

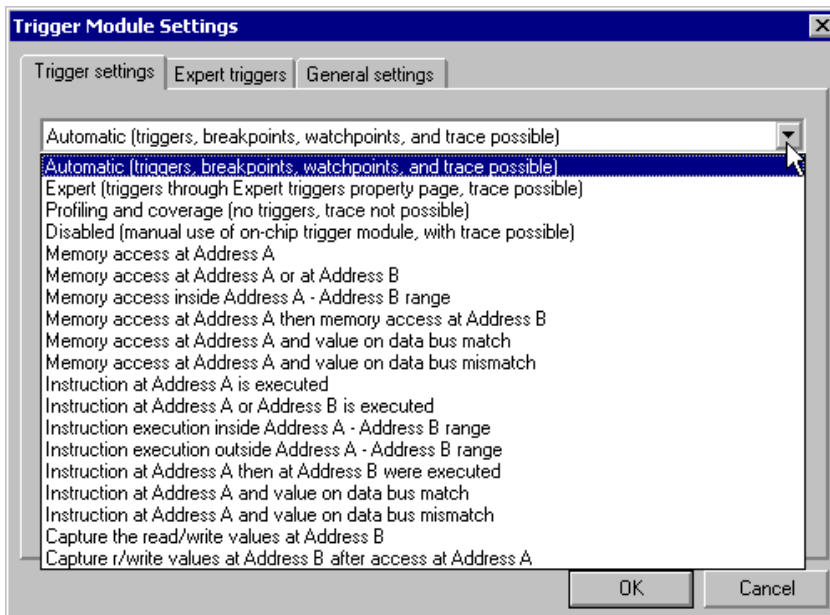

Automatic Mode (Default)

The DBG Module is used to set up three hardware breakpoints or one watchpoint or to set up triggers selected by the user from the list or from a context sensitive context menu. This mode is simply the default selection when no triggers have been set yet.

The trigger condition and trigger addresses can be set from the debugger Source, Assembly, Memory and Data component using Set Trigger A or Set Trigger B context-sensitive menu entry, or within this dialog box.

The DBG module is setup to record the executed change of flows. As no triggers are set, the debugger is stopped on the user request or typical breakpoints/watchpoint. To summarize, in this mode, the DBG module is used to set regular hardware breakpoints and watchpoints.

Expert Mode

The User needs to know the on-chip DBG module really well to use this mode. It can be seen as a “Do It Yourself” way to set the DBG module. The HCS08 core manual is needed to understand the meaning of the registers and flags.

The triggers comparator addresses can be set from the debugger Source, Assembly, Memory and Data windows using Set DBGCA or Set DBGCB. The DBG module is set by the debugger. DBG module enabling and arming depend on the selected flags set within the DBG register control registers (through the Expert triggers tab property page). The settings are written to the hardware right before the application is run. The DBG module is reset when the application stops.

Figure 23.17 Trigger Settings Tab - Expert Mode Information

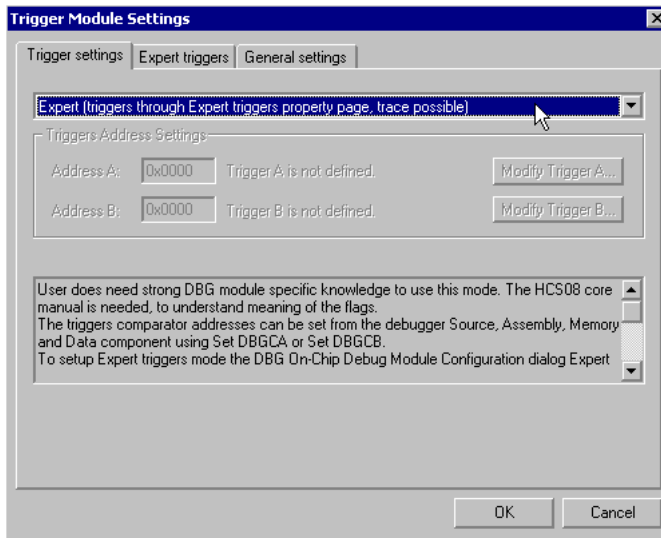

To set Expert triggers, the Trigger Module Settings window **Expert triggers** tab must be used. Select the **Expert** mode in the list menu to enable the [Expert Mode Tab](#).

Expert Mode Tab

The expert mode tab gives you an access to most of the on-chip DBG module registers. Trigger types can be directly set from the **DBGT - Debugger Trigger Register** list menu.

Code program flow rebuild and data recording are also synchronized with the Expert mode and results are displayed in the [Trace Component Window](#).

Figure 23.18 Trigger Module Settings Window - Expert Triggers Tab

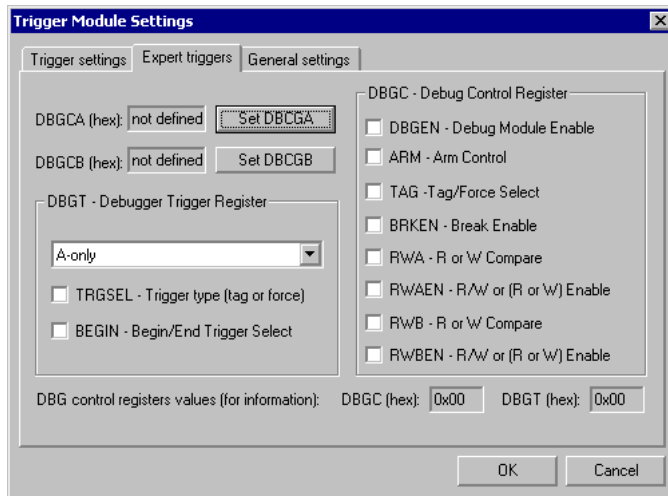

Profiling and Coverage Mode

Choosing this mode, the DBG module is set up to source code execution profiling and source code execution coverage. Open the Profiler and/or Coverage components to display results.

Neither triggers nor DBG based controlpoints can be set in this mode, and the debugger must be stopped on user request (software breakpoints can still be used).

Profiling and Coverage features are based on a periodical debugger program counter real time fetch from the debugger to the on-chip DBG module. Also this fetch is statistical and cannot cover all program counters. The longer the program runs the more precise are the statistics.

See also [Limitations](#) section for this mode.

Refer to the debugger engine manual for Coverage and Profiler component features.

HCS08 On-Chip DBG Module

Trigger Module Settings Window

Figure 23.19 Debugger Main Window - Coverage and Profiler Windows

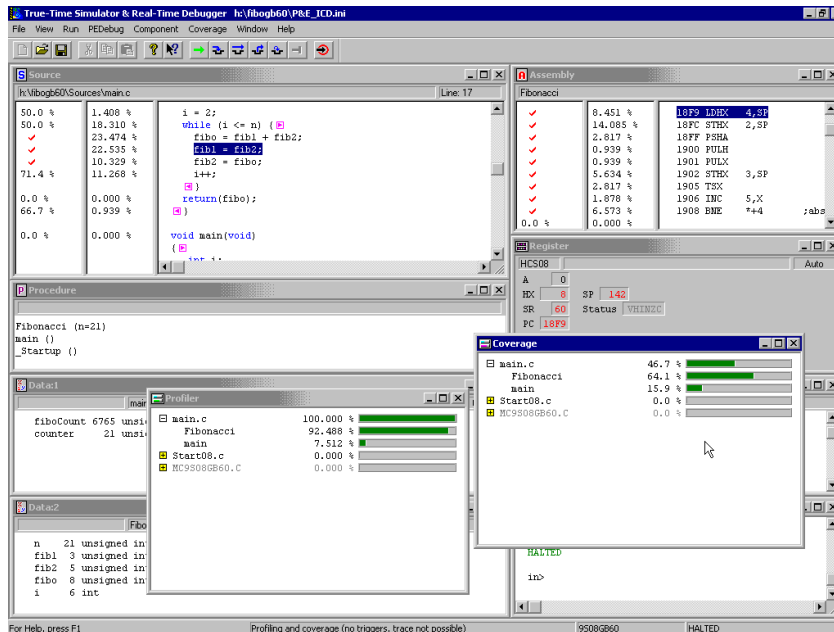

Disabled Mode

The user needs to know the on-chip DBG module to use this mode. It can be seen as a “Do It Yourself” way to set hardware breakpoints, watchpoints, and triggers. Consult the [Reference Document](#) section and documents to get all information about the HCS08 on-chip DBG module before attempting to use this mode.

There is no dedicated graphical user interface to access the DBG module. The triggers comparator addresses and DBG control registers are handled by the user through the debugger Memory component or using command line commands. The DBG module is NOT set by the debugger. DBG module enabling and arming depend on the selected flags set within the DBG register control registers. The DBG module is NOT reset when the application stops. By default, the FIFO content is protected from unexpected reads, the DBG module is automatically disarmed and the FIFO is analyzed when the debugger stops. This can be optionally disabled by the user.

Memory Access Triggers

This section describes the various types of Memory Access Triggers available on the on-chip debug module.

Memory Access at Address A

This mode is used to trigger on a program instruction read and/or write at Address A memory location.

The code program flow rebuild is displayed in the [Trace Component Window](#) automatically and switched to [Instructions Display](#) mode.

Memory Access at Address A or Address B

This mode is used to trigger on a program instruction read and/or write at Address A or at Address B memory location.

The code program flow rebuild is displayed in the [Trace Component Window](#) automatically and switched to [Instructions Display](#) mode.

Memory Access Inside Address A - Address B Range

This mode is used to trigger on a program instruction read and/or write inside the Address A - Address B memory range locations.

The code program flow rebuild is displayed in the [Trace Component Window](#) and automatically switched to [Instructions Display](#) mode.

Memory Access at Address A then Memory Access at Address B

This mode is used to trigger on a program instruction sequence first reading and/or writing at Address A memory location then reading and/or writing at Address B memory location.

The code program flow rebuild is displayed in the [Trace Component Window](#) and automatically switched to [Instructions Display](#) mode.

Memory Access at Address A and Value on Data Bus Match

This mode is used to trigger on a program instruction read and/or write of a specific matching byte value at Address A memory location.

When choosing this trigger type, the **trigger B** address is used as a **match value** rather than an address. Also when setting this trigger via a context sensitive context menu, the following message is displayed if the match value was never set.

Figure 23.20 Memory Access at Address A and Value on Data Bus Match Dialog Box

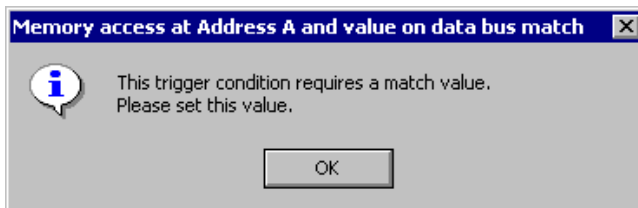

The [Trigger Editing](#) dialog box is not available for trigger B. Special *Match value* edit boxes are displayed instead of *Address B* edit box.

Figure 23.21 Trigger Address Settings Dialog Box

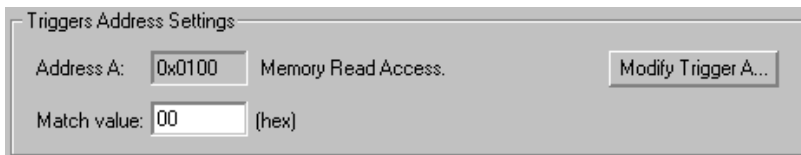

The code program flow rebuild is displayed in the [Trace Component Window](#) automatically switched to [Instructions Display](#) mode.

Memory Access at Address A and Value on Data Bus Mismatch

This mode is used to trigger on a program instruction read and/or write of a NOT matching byte value at Address A memory location.

When choosing this trigger type, the **trigger B** address is used as a **mismatch value** rather than an address. Also when setting this trigger via a context sensitive context menu, the following message is displayed if the match value was never set.

Figure 23.22 Memory Access at Address A and Value on Data Bus Mismatch Dialog Box

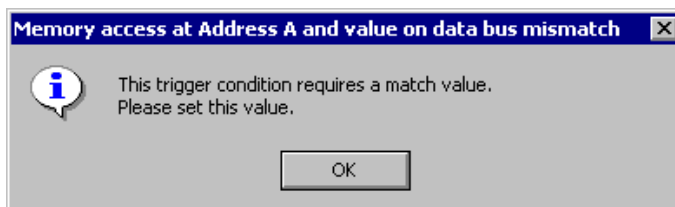

The [Trigger Editing](#) dialog box is not available for the trigger B. Special **Match value** edit boxes are displayed instead of **Address B** edit box.

Figure 23.23 Trigger Address Settings Dialog Box

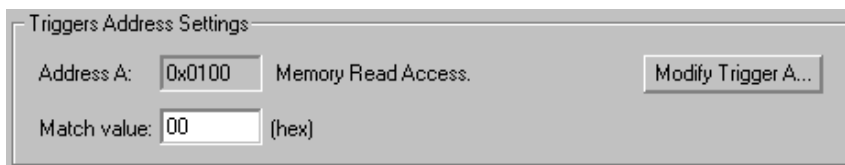

The code program flow rebuild is displayed in the [Trace Component Window](#) automatically switched to [Instructions Display](#) mode.

Instruction Triggers

This section describes triggers associated with specific instructions.

Instruction at Address A is Executed

This mode is used to trigger on a program instruction execution (program counter) at Address A.

The code program flow rebuild is displayed in the [Trace Component Window](#) automatically switched to [Instructions Display](#) mode.

Instruction at Address A or Address B is Executed

This mode is used to trigger on a program instruction execution (program counter) at Address A or at Address B.

The code program flow rebuild is displayed in the [Trace Component Window](#) automatically switched to [Instructions Display](#) mode.

Instruction Execution Inside Address A - Address B Range

This mode is used to trigger on a program instruction execution (program counter) inside the Address A - Address B range.

The code program flow rebuild is displayed in the [Trace Component Window](#) and automatically switched to [Instructions Display](#) mode.

Instruction Execution Outside Address A - Address B Range

This mode is used to trigger on a program instruction execution (program counter) outside the Address A - Address B range.

NOTE **IMPORTANT:** With the **HCS08 Serial Monitor via GDI connection**, this trigger type might be interfered with by the monitor code itself and therefore the debugger might break for executed code not belonging to the user application.

The code program flow rebuild is displayed in the [Trace Component Window](#) automatically switched to [Instructions Display](#) mode.

Instructions at Address A then at Address B were Executed

This mode is used to trigger on a program instruction execution (program counter) sequence first at Address A then at Address B.

The code program flow rebuild is displayed in the [Trace Component Window](#) automatically switched to [Instructions Display](#) mode.

Instruction at Address A and Value on Data Bus Match

This mode is used to trigger on a program instruction execution (program counter) at Address A, this instruction opcode matching a specific byte value.

When choosing this trigger type, the **trigger B** address is used as a **match value** rather than an address. Also when setting this trigger via a context sensitive context menu, the following message is displayed if the match value was never set.

Figure 23.24 Memory Access at Address A and Value on Data Bus Match Dialog Box

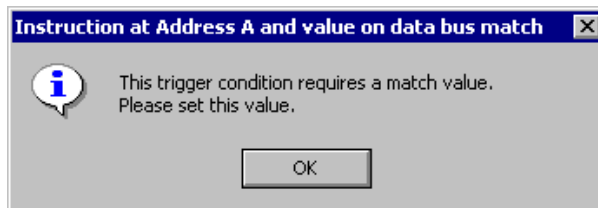

The [Trigger Editing](#) dialog box is not available for the trigger B. Special **Match value** edit boxes are displayed instead of **Address B** edit box.

Figure 23.25 Trigger Address Settings Dialog Box

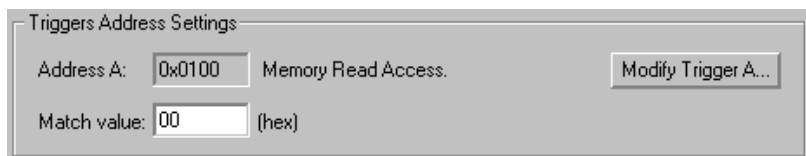

The code program flow rebuild is displayed in the [Trace Component Window](#) automatically switched to [Instructions Display](#) mode.

Instruction at Address A and Value on Data Bus Mismatch

This mode is used to trigger on a program instruction execution (program counter) at Address A, this instruction opcode NOT matching a specific byte value.

When choosing this trigger type, the **trigger B** address is used as a **mismatch value** rather than an address. Also when setting this trigger via a context sensitive context menu, the following message is displayed if the match value was never set.

HCS08 On-Chip DBG Module

Trigger Module Settings Window

Figure 23.26 Memory Access at Address A and Value on Data Bus Mismatch Dialog Box

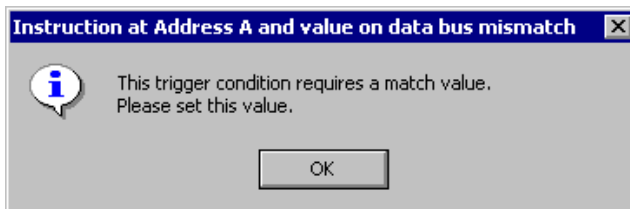

The [Trigger Editing](#) dialog box is not available for the trigger B. Special **Match value** edit boxes are displayed instead of **Address B** edit box.

Figure 23.27 Trigger Address Settings Dialog Box

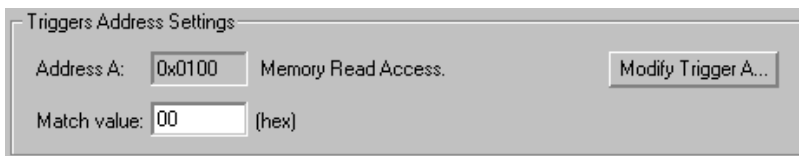

The code program flow rebuild is displayed in the [Trace Component Window](#) automatically switched to [Instructions Display](#) mode.

Capture Triggers

Capture Read/Write Values at Address B

This mode is used to capture the data involved in a read and/or write access to the address specified by the **trigger B**, such as the address of a particular control register or program variable.

Captured byte data are displayed in the [Trace Component Window](#) automatically switched to [Recorded Data Display](#) mode.

The trigger address is typically not a program code address (program counter), but rather a data/memory address.

Capture Read/Write Values at Address B After Access at Address A

This mode is used to capture the data involved in a read and/or write access to the addresses specified by the **trigger A** and the **trigger B**, such as the address of a particular control register or program variable. Triggering/capture starts only after accessing the **trigger A** address.

The trigger addresses is typically not a program code address (program counter), but rather data/memory addresses.

Captured byte data is displayed in the [Trace Component Window](#) and automatically switched to [Recorded Data Display](#) mode.

DBG Module Options

This section details the options available with the DBG module.

Program Code Change of Flow Recording

The program code change of flow options are available for [Instruction Triggers](#) and [Memory Access Triggers](#) and controlled through the **Trigger Settings** tab list box of the **Trigger Module Settings** window.

Figure 23.28 Change of Flow Recording Control

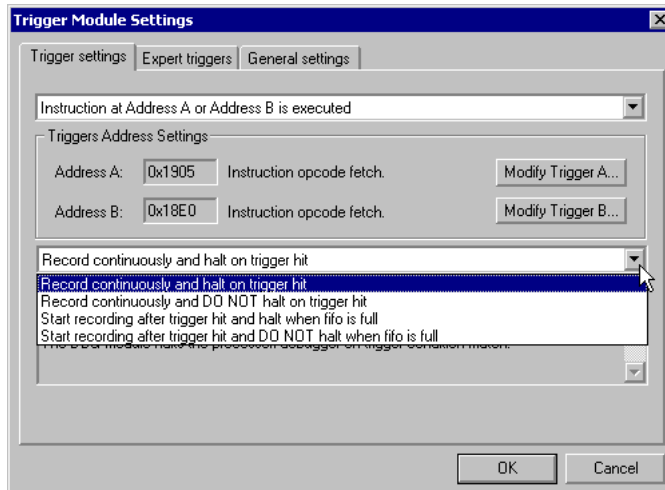

- **Record continuously and halt on trigger hit:** The DBG module starts recording program flow information immediately after run. The DBG module halts the processor/debugger on trigger condition match.
- **Record continuously and DO NOT halt on trigger hit:** The DBG module starts recording program flow information immediately after run. The DBG module does not halt the processor/debugger on trigger condition match.
- **Start recording after trigger hit and halt when the fifo is full:** The DBG module starts recording program flow information on trigger condition match and halts the processor/debugger when the capture buffer is full.

HCS08 On-Chip DBG Module

Trigger Module Settings Window

- **Start recording after trigger hit and DO NOT halt when the fifo is full:** The DBG module starts recording program flow information on trigger condition match. The DBG module does not halt the processor/debugger on trigger condition match.

Data Recording

The data recording options are available for [Capture Triggers](#) only and are selected from the list box in the Trigger Settings tab of the Trigger Module Settings window.

Figure 23.29 Data Recording Control

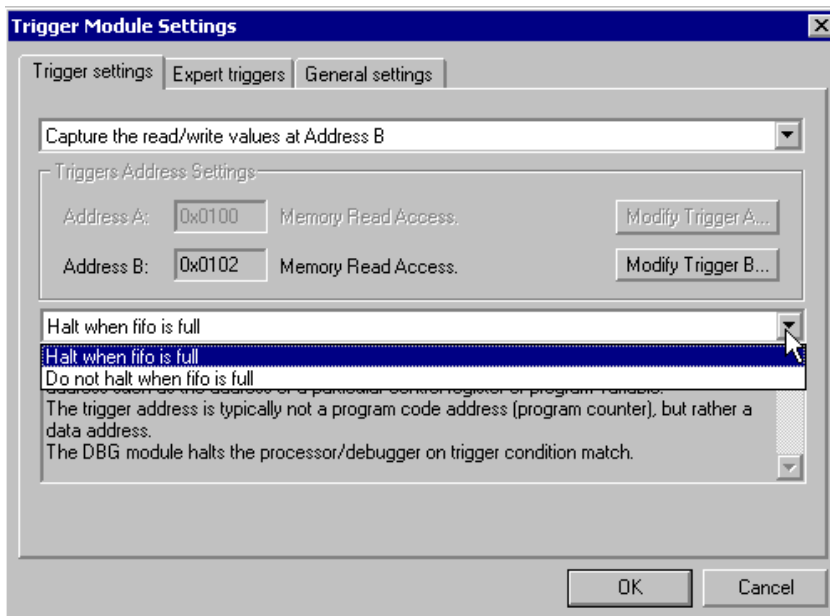

- **Halt when the fifo is full:** The DBG module records data accesses continuously and halts the processor/debugger when the capture buffer is full.
- **Do not halt when the fifo is full:** The DBG module records data accesses continuously but does not halt the processor/debugger when the capture buffer is full.

Trigger Editing

Typically trigger addresses and/or type can be set using context sensitive context menus. It is also possible to modify trigger addresses and type within the [Trigger Module Settings Window](#). Pressing **Modify Trigger** buttons opens a trigger editor dialog box.

Figure 23.30 Browse for Trigger A Dialog Box

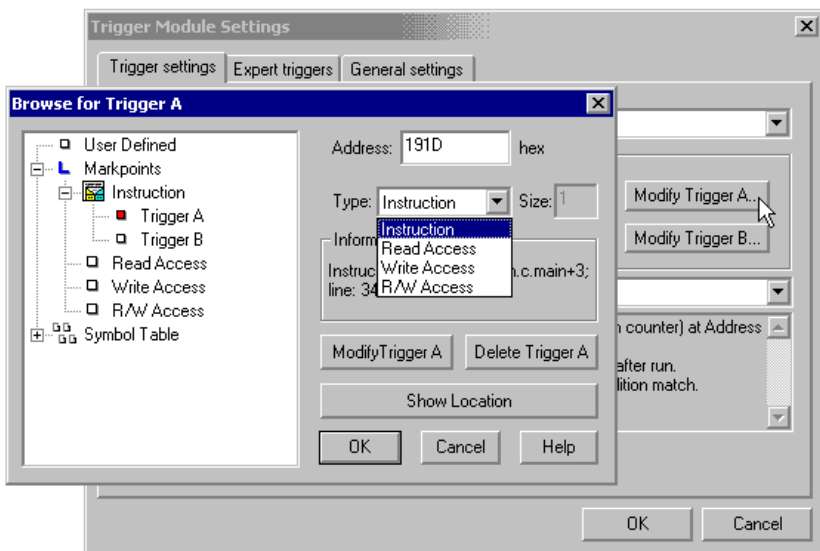

In the trigger editor dialog box:

- The **Address** edit box contains the initial and final trigger address value. This value can be directly set by typing in the edit box.
- Use the **Type** list menu to select/change the type of trigger. Use **Instruction** type for [Instruction Triggers](#) and **Read**, **Write** and **R/W Access** for [Memory Access Triggers](#) and [Capture Triggers](#).
- Pressing **Modify Trigger** in this sub-dialog box modifies and records the trigger in the trigger database ([Trigger Stored as Markpoints](#)).

NOTE Pressing the OK button does NOT update the trigger database. The **Modify Trigger** button in the Trigger Module Settings window must be explicitly pressed before closing the dialog box to update the trigger database.

- Pressing **Delete Trigger** in the dialog box removes the trigger in the trigger database ([Trigger Stored as Markpoints](#)). This trigger address is then considered **undefined**.

HCS08 On-Chip DBG Module

Trigger Module Settings Window

- The **Show Location** button shows the location of the trigger (as program code location or program data) in the Source, Data, Assembly and Memory windows.

The left side of the tree is a user-friendly way to find a trigger address in the debugger symbol database by selecting a variable (the address of the variable is taken and copied in the **Address** edit box) or a function (the entry point of the function is taken and copied in the **Address** edit box), and also regular markpoints (the address of the markpoint is taken and copied in the **Address** edit box) from the markpoint list.

Figure 23.31 Finding Trigger Address in Editor Dialog Box

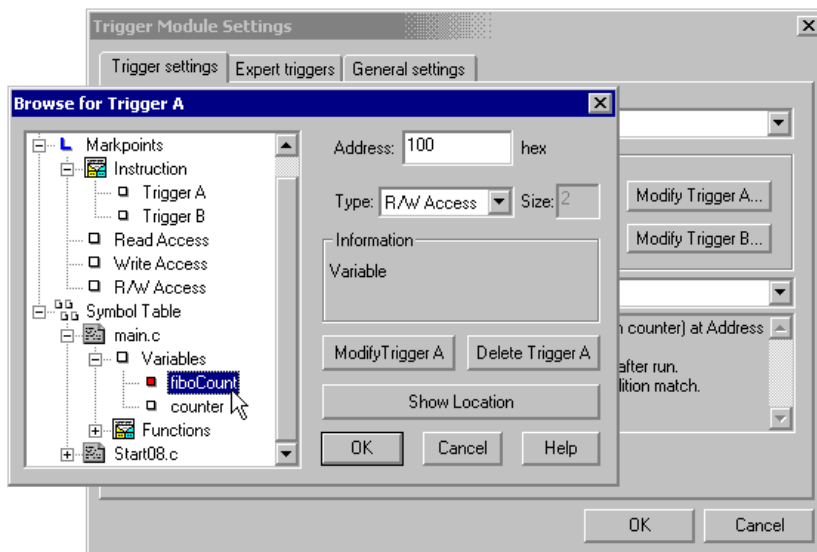

Trigger Module Settings Window - Display Information

A large grayed edit box dynamically provides information about the current triggers and selected options.

As context sensitive menus only display triggers matching the amount and the kind of triggers which are currently set, the [Trigger Module Settings Window](#) dynamically checks the validity of current triggers set vs. the trigger mode.

As shown below, if one or more triggers do not match the trigger mode selection, a warning icon and message appears on the bottom of the dialog box.

Here, the **Memory Write Access** type of trigger selected by the mouse cursor does not match with the [Instruction Triggers](#) type selected in the list menu.

Figure 23.32 Trigger Settings Tab Information

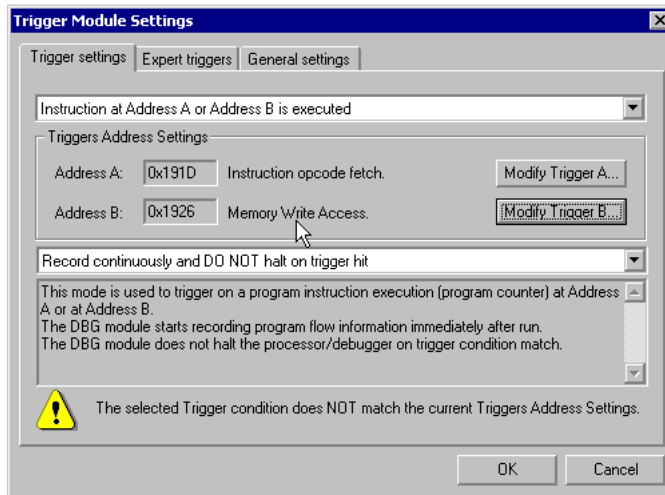

General Settings Tab

Most of the time, there is no reason to change any of these settings, which are default settings of the DBG user interface. However, in some debug special cases, it is possible to disable some automated debugger background processes.

Figure 23.33 Trigger Module Settings Window - General Settings Tab

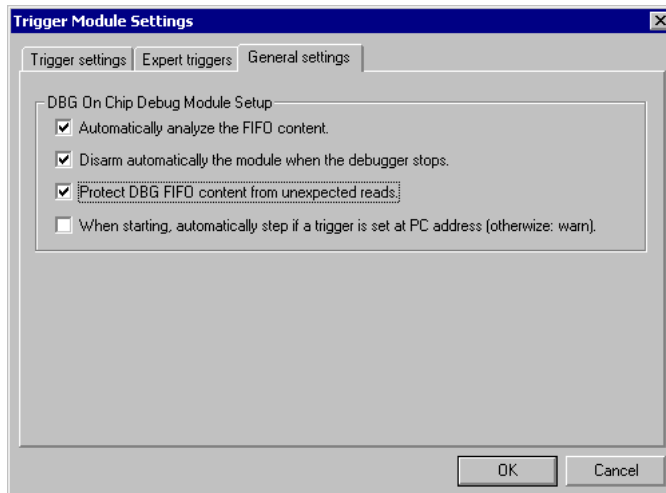

HCS08 On-Chip DBG Module

Trace Component Window

- **Automatically analyze the FIFO content:** When the [Trace Component Window](#) is open, after the debugger is halted by the user or a breakpoint, watchpoint or a trigger, DBG module results are automatically analyzed then displayed in the Trace window. If the Trace window is closed, the DBG user interface does not perform any result analysis except trigger flags reported in the status bar. Unchecking this check box does the same, with the Trace window open.
- **Disarm the module automatically when the debugger stops:** By default, halting the debugger target processor with a user break (not a trigger) does not disarm the on-chip DGB module. If you leave this option selected (the default) the debugger disarms it to retrieve data from the DBG Fifo. If not selected, the DBG Fifo/buffer information cannot be retrieved until the module is disarmed.
- **Protect DBG FIFO content from unexpected reads:** The DBG Fifo data are retrieved from *DBGFH-DBGFL* registers (address 0x1814-0x1815 in register block at reset location). Several reads are performed to retrieve the entire shifting buffer. However, when the debugger is halted, while refreshing Data and Assembly windows, it might read also the debugger target processor memory at the same location, reading the first DBG Fifo data, shifting the buffer, and therefore corrupt the DBG user interface DBG Fifo data retrieving. This option hides to the debugger and also user (see blue "-- --" designs in the Memory window at address 0x1814-0x1815) the DBG Fifo buffer location.
- **When starting, automatically step if a trigger is set at PC address (otherwise: warn):** To run again the application, the debugger usually needs to exit the trigger current match condition and avoid being stuck/halted/locked by the trigger. A single step is usually required to "escape" from [Instruction Triggers](#). When this option is disabled, the debugger prompts the following dialog box to validate this choice.

Figure 23.34 Trigger "Escape" Dialog Box

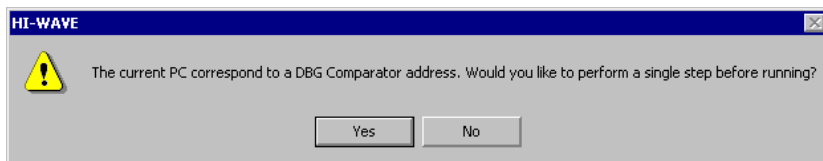

Trace Component Window

The Trace component is a debugger generic component used to display in a Trace window a debugger internal database. The context sensitive context menu is set up by the connection (or the GDI DLL) using the component.

Any debugger connections including the DBG user interface are synchronized with the Trace component.

It is not necessary to open the Trace window/component to make use of the DBG user interface triggers. However, several triggers are used to collect code program flow information or access data information. The Trace window can be opened from [Specific Connection Menu Options](#), from [Context Menu Entries in Source, Data, Assembly and Memory Windows](#), and from the [DBG Support Status Bar Item](#). The window can be saved in the debugger layout when pressing the debugger Save icon.

NOTE When the Trace component/window is closed, the debugger might be faster, as code program flow rebuild is discarded, this last disassembling back the assembly data from the connection CPU's memory.

Instructions Display

This display mode is automatically set when [Instruction Triggers](#) and [Memory Access Triggers](#) are used. It is also the default display in [Automatic Mode \(Default\)](#).

Displayed columns:

- **Frame**: A number representing an information item stored in the Trace component database.
- **Address**: instruction program counter.
- **Instruction**: code program flow instruction disassembly.
- **FIFO Analyze remark**: debugger information: **DBG FIFO data** means that this data was recorded by the on-chip DBG module. **Traced** means an item/instruction obtained by debugger/user single step or assembly step. **Program flow rebuild gap** means that the debugger was unable to completely track the code program flow between two frames.

HCS08 On-Chip DBG Module

Trace Component Window

Figure 23.35 Trace Window - Context Menu Options

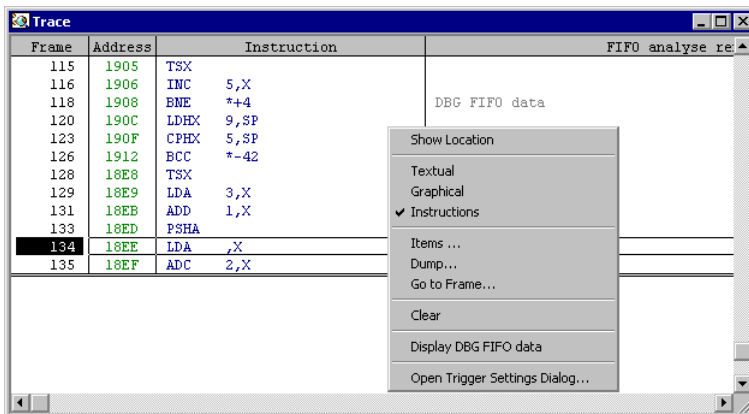

Selecting **Show Location** in the Trace window causes a context sensitive menu to appear in Source and Assembly window the frame matching source and assembly code.

Graphical Display

You can select this display mode when selecting **Graphical** in the Trace window context sensitive menu. It provides a graphical representation of the same information.

Figure 23.36 Trace Window - Graphical Display

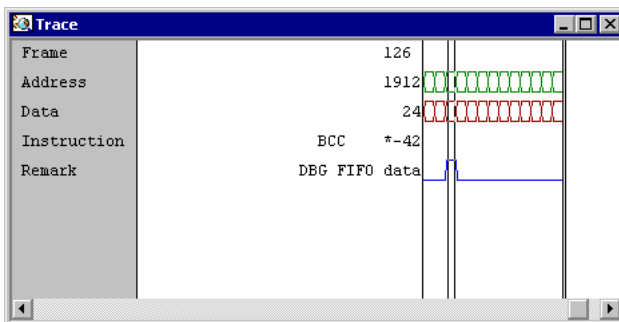

Textual Display

This display mode can be select when selecting **Textual** in the Trace window context sensitive context menu, when using [Instruction Triggers](#) and [Memory Access Triggers](#) are used. This display mode is rather useless for the DBG user interface, as no read/write accesses are recorded at the same time than program change of flow information by the

on-chip DBG module. By consequence, the Textual display mode simply expands instruction assembly code in the Trace window.

Figure 23.37 Trace Window - Textual Display

Frame	Address	Data	Instruction	FIFO ar
119	1909	02		
120	190C	9E	LDEX 9,SP	
121	190D	FE		
122	190E	09		
123	190F	9E	CPHX 5,SP	
124	1910	F3		
125	1911	05		
126	1912	24	BCC *-42	DBG FIFO data
127	1913	D4		
128	18E8	95	TSX	
129	18E9	E6	LDA 3,X	
130	18EA	03		
131	18EB	EB	ADD 1,X	
132	18EC	01		
133	18ED	87	PSHA	
134	18EE	F6	LDA ,X	
135	18EF	E9	ADC 2,X	
136	18F0	02		

Column Display and Moving

Selecting *Items* in the Trace window context sensitive menu opens a small dialog box to setup the columns to hide/display in each display mode. The *Displaying mode* list menu can be opened to make column display modification in *Textual*, *Instructions* or *Graphical* mode.

Figure 23.38 Items Configuration Dialog Box

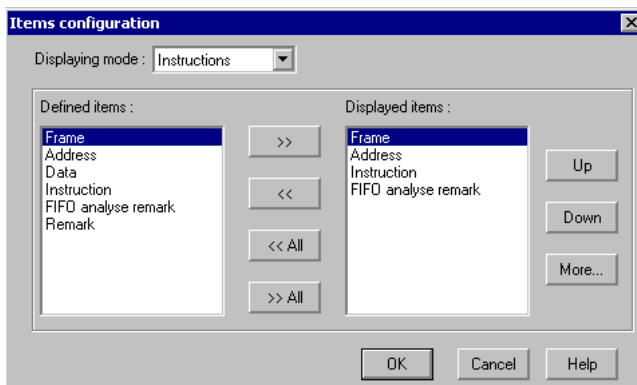

Dumping Frames to File

Selecting *Dump* in the Trace window context sensitive context menu opens a small dialog box to dump/save Trace component frames to a text file.

Figure 23.39 Dump Trace Frames Dialog Box

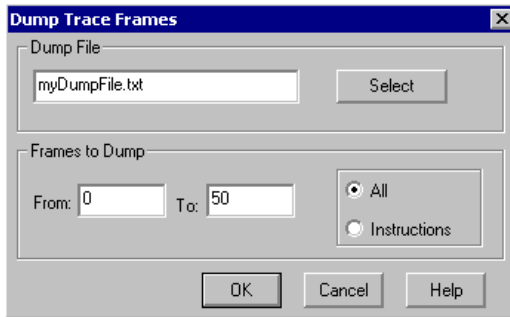

Goto Frame

Selecting *Go to Frame* in the Trace window context sensitive context menu opens a small dialog box to go to a frame in the Trace window.

Figure 23.40 Search Frames Dialog Box

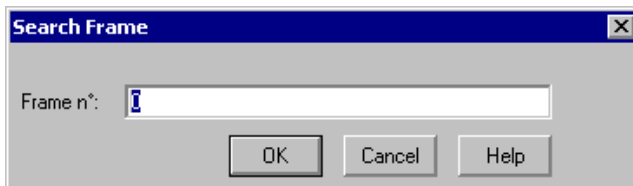

Clearing Frames

Selecting *Clear* in the Trace window context sensitive menu flushes the frames in the Trace window (flushing in background the database).

DBG Module FIFO/Buffer Display

Selecting *Display DBG FIFO data* in the Trace window context sensitive menu displays data information retrieved from the on-chip DGB module Fifo/buffer. Selecting *Display program flow* in the Trace window context sensitive menu displays code program flow.

Displayed columns:

- **FIFO Depth:** A number representing the depth in the DBG/Fifo of the word data value. The first frame (Depth 1) is the oldest value in the time.
- **DBG FIFO Data:** the word value retrieved from the DBG Fifo/buffer from DBGFH and DBGFL DBG on-chip module registers.

Figure 23.41 Trace Window - FIFO Display

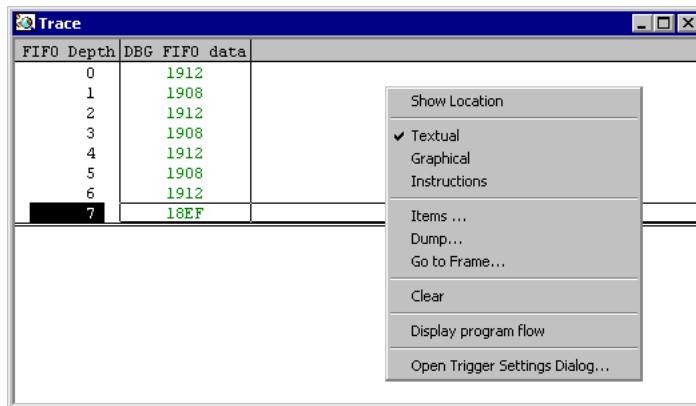

Recorded Data Display

This display mode is automatically set when [Capture Triggers](#) are used.

Displayed columns:

- **FIFO Depth:** A number representing the depth in the DBG/Fifo of the byte data value. The first frame (Depth 1) is the oldest value in the time.
- **Data value:** the byte value retrieved from the DBG Fifo/buffer from the DBGFL DBG on-chip module register.

Figure 23.42 Trace Window - Recorded Data Display

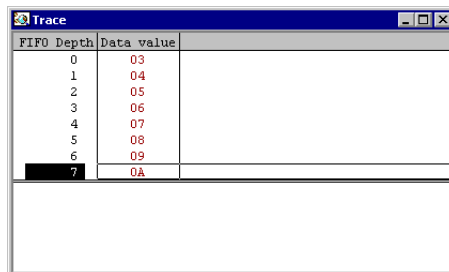

Limitations

The following limitations apply in demo/unregistered debugger mode:

- In demo/unregistered debugger mode, code program reconstruction has a limited number of frames displayed in the Trace window.
- Real time code Profiling and code Coverage are disabled.
- No preset/predefined [Instruction Triggers](#), [Memory Access Triggers](#) or [Capture Triggers](#) are provided. Only [Expert Triggers](#) can be set.

HCS08 DBG V3 New Features

The following new features are available on version 3 of the HCS08 DBG Module.

MMU and Extended Address Space

By design, the DBG V3 module is compliant with newer devices with the on-chip Memory Management Unit module, like the MC9S08QE128 devices. The extended address space memory accesses are supported, and also program flow recording and rebuild of applications running over PPAGE paging windows (banked memory model).

LOOP1 mode

The on-chip DBG V3 module (available for example on MC9S08QE128 devices) provides some new features, like an additional comparator that is typically used as a third hardware breakpoint, that is not involved in the trigger logic except in a new recording mode call LOOP1. In LOOP1 mode, the DBG module verifies if the last captured change of flow is already recorded in the DBG fifo database, and if it is the case, the fifo database is not changed and the capture discarded. This avoids recording short loop changes of flow that can quickly fill completely the database without providing relevant debug information. For example, this improves efficiency when executing a DBNZ instruction by recording instruction branching only once.

Select the LOOP1 module in the Trigger Module Settings dialog by selecting **FIFO LOOP1 mode** in a list menu. The genuine mode is called **FIFO Normal mode**.

Figure 23.43 LOOP1 recording mode selection

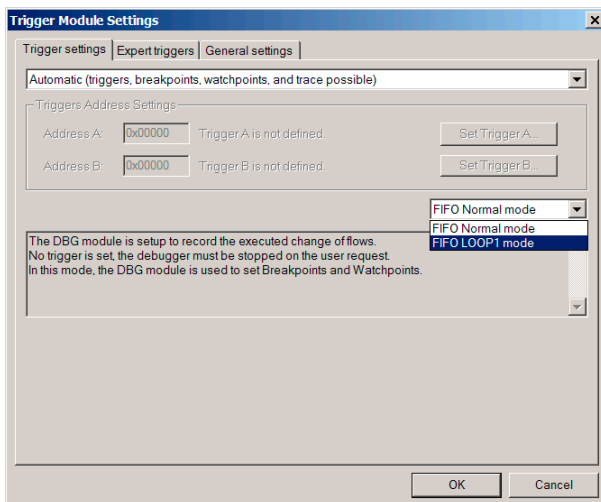

Ability to record until Reset and from Reset

The DBG module now has the ability to record data up until a reset occurs, and can begin recording immediately after reset.

Recording until reset

The on-chip DBG V3 module can keep in a database the last data recorded right before a reset occurred, therefore the debugger is now able to trace what happened right before a reset occurred, at the condition that the module was initially armed to record continuously.

At next debugger stop, the debugger displays in the Trace window the last recorded instructions and, in red color, the last instructions that could have been executed and generated a reset.

Also the debugger displays in the status bar the source of the reset decoded from the System Reset Status (SRS) on-chip register.

CAUTION After interpreting the Trace window recorded information, reset the debugger and hardware (press the debugger *Reset* button) to clear the SRS register. This ensures a correct debugger analysis from the next reset capture.

HCS08 On-Chip DBG Module

HCS08 DBG V3 New Features

Figure 23.44 Recording a PIN reset

The screenshot shows a debugger's Trace window with the following content:

Frame	Address	Instruction	FIFO analyse re
59	21CF	STA 0x1803	
62	21D2	MOV #0xFF,0x05	
65	21D5	CLR 0x04	
67	21D7	CLI	
68	21D8	LDHX 0x0100	
71	21DB	AIX #1	
73	21DD	STHX 0x0100	
76	21E0	CLRX	
77	21E1	CLRH	
78	21E2	STHX 0x0104	
81	21E5	TSX	
82	21E6	CLR 2,X	
84	21E8	CLR 1,X	
86	21EA	LDHX #0x0104	
89	21ED	INC 1,X	
91	21EF	BNE +4	DBG FIFO data 2
=====			
94	21F2	STA 0x1800	Possible Reset Detected!!!
97	21F5	LDHX 0x0104	
100	21F8	JSR 0x2116	
103	2116	PSHX	Address A
104	2117	PSHH	
105	2118	AIS #-8	
107	211A	TSX	
108	211B	CLR 1,X	
110	211D	CLR ,X	
111	211E	LDX #0x01	
113	2120	CLRH	
114	2121	STHX 3,SP	
117	2124	LDHX 9,SP	
120	2127	STHX 7,SP	
123	212A	LDX #0x02	
125	212C	CLRH	
126	212D	STHX 5,SP	
129	2130	BRA **+41	
131	2159	LDHX 9,SP	
134	215C	CPHX 5,SP	
137	215F	BCC *-45	
=====			
Reset has occurred after the last FIFO value recorded,			

At the bottom of the window, the status bar shows: Automatic (triggers, breakpoints, watchpoints, and trace possible) | 9S08QE128 | ICD | PIN Reset occurred

Figure 23.45 Recording an illegal opcode reset

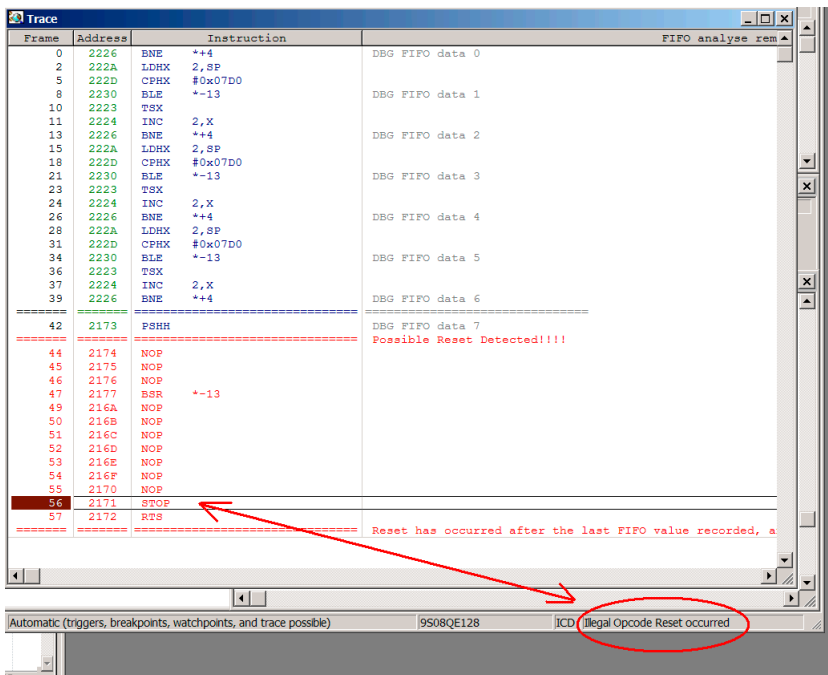

Recording from Reset

In other cases, including Power On Reset (POR), the DBG module starts recording immediately out of reset. The Trigger Module Settings dialog provides a new setup to capture this recording from the reset vector entry point, when selecting “Start recording from asynchronous reset”.

HCS08 On-Chip DBG Module

HCS08 DBG V3 New Features

Figure 23.46 Recording out of reset mode selection

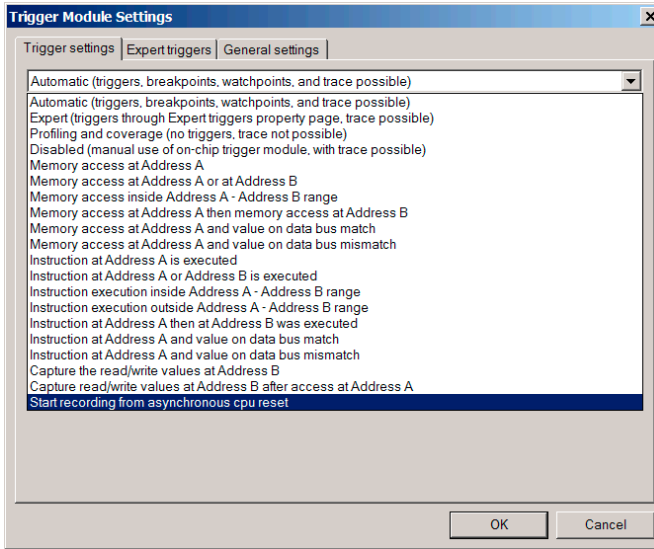
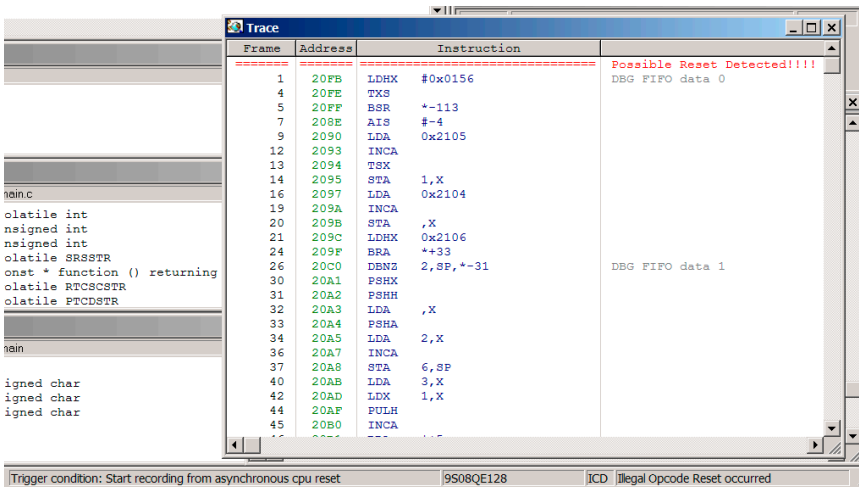

Figure 23.47 Start recording from Reset trace



CAUTION After interpreting the Trace window recorded information, reset the debugger and hardware (pressing the debugger Reset button) to clear the SRS register. This ensures a correct debugger analysis from the next reset capture.

Expert Triggers tab extended

The Expert Triggers tab has been redesigned and extended with the newest comparator “C” controls.

Figure 23.48 Expert Triggers tab

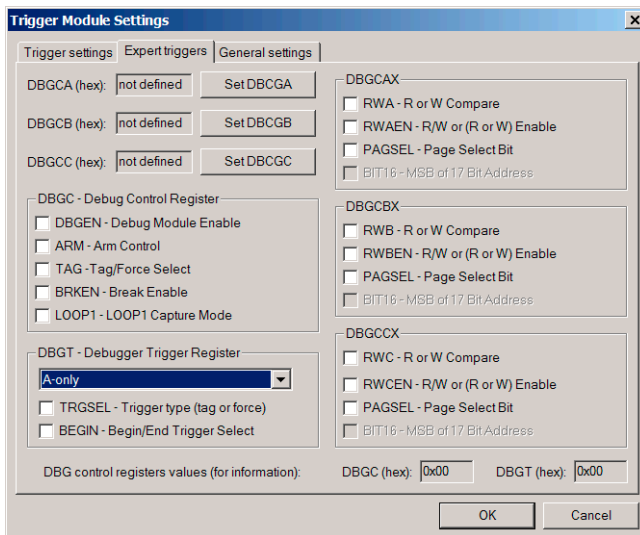



HCS08 On-Chip DBG Module

HCS08 DBG V3 New Features

Book IV - RS08 Debug Connections

Book IV Contents

Each section of the Debugger manual includes information to help you become more familiar with the Debugger, to use all its functions and help you understand how to use the environment. This book, the RS08 Debugger Connections, defines the connections available for debugging code written for RS08 CPUs.

This book consists of the following sections:

- [RS08 Full Chip Simulation](#)
- [RS08 P&E Multilink/Cyclone Pro Connection](#)
- [RS08 Open Source BDM Connection](#)
- [SofTec RS08 Connection](#)



Book IV Contents

RS08 Full Chip Simulation

Full Chip Simulation (FCS) does not involve real input and output. Because of this, it does not require a target device to be connected to your PC. The RS08FCS connection simulates code execution on the user's MCU system, including the function of any peripherals associated with the device that you select. For more detailed information, refer to the Full Chip Simulation description for the module that you are using.

Configuration Procedure

To select Full Chip Simulation as the debugger connection:

1. Choose the Full Chip Simulation option from the set connection dialog box. See [Figure 24.1](#).
2. Click the OK button.

Figure 24.1 Set Connection Dialog Box

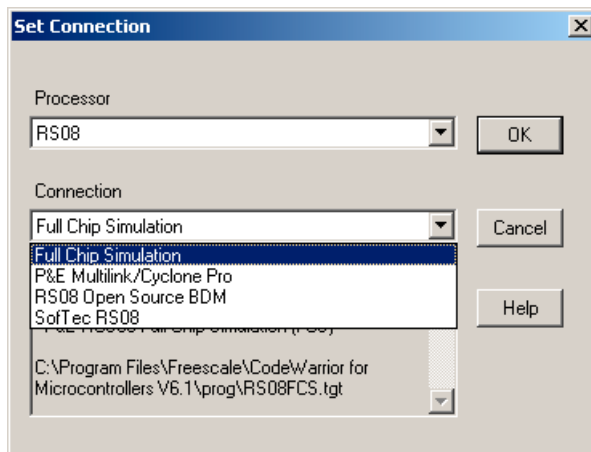

Connection (RS08FCS) Menu

Once you have chosen Full Chip Simulation as your debugger connection, the name of the Connection menu is updated and additional options are added.

Figure 24.2 RS08FCS Menu

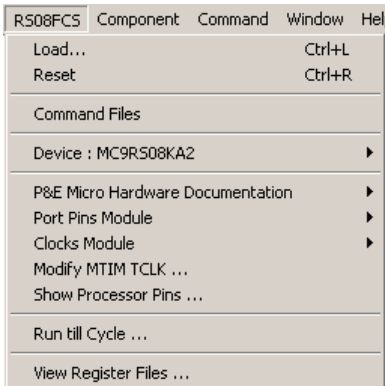

Device Option

The Device selection of the RS08FCS menu allows the user to select the particular Freescale processor that they wish to use. When choosing the Device option from the RS08FCS menu, extended menus open which allow you to select the family (e.g. KA Family), and device type (e.g. MC9RS08KA2) of the MCU that you are using.

Figure 24.3 RS08FCS Device Extended Menus

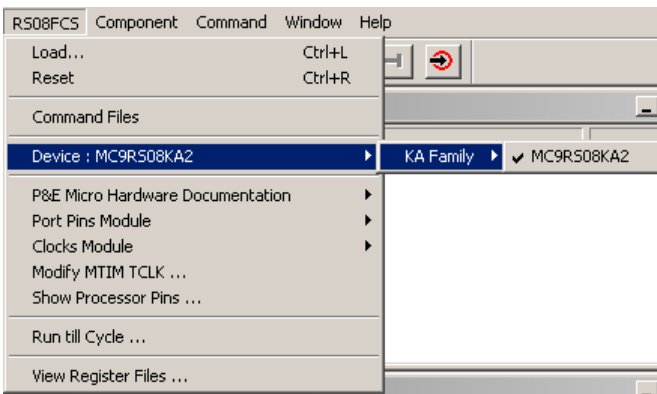

Full Chip Simulation Module Commands

The RS08FCS Menu contains the Full Chip Simulation commands for the modules that have specialty commands associated with them for a chosen device. For more information about specific module commands refer to the Full Chip Simulation section describing the module.

Port Pins Module

[Figure 24.4](#) shows the simulated port inputs dialog box.

Figure 24.4 Simulated Port Inputs Dialog Box

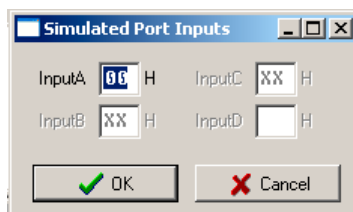

The port pins module menu contains the option to show the input pin levels dialog box (this corresponds to the INPUTS command). The dialog box graphically displays the current value of the inputs buffers for all available I/O ports on the device (note that this may not reflect the value shown in the memory window, depending on the current state of a given port's data direction register).

The input buffer can be directly modified from this dialog box.

Modify MTIM TCLK

[Figure 24.5](#) shows the TCLK frequency dialog box.

Figure 24.5 TCLK Frequency Dialog Box

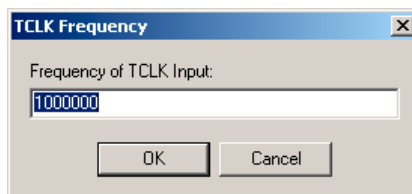

This dialog box allows the user to set the frequency of the TCLK signal for the MTIM peripheral. In order for this value to have any effect, the TCLK must be selected as the clock source for the MTIM.

Show Processor Pins

The Processor Pins dialog box is a convenient tool for monitoring the current state of the processor pins, as well as the peripheral with which a pin may be associated. The processor is represented, in graphical form, in the middle of the dialog box. Each pin is labeled with its current function. For example, Pin 2 is the BKGD pin upon reset. However, with the appropriate write to the SOPT register, the user can observe that Pin 2 changes to PTA3 in the Processor Pins dialog box.

In the dialog box, each processor pin (with the exception of the power pins, Vdd and GND) has a corresponding arrow. If the arrow points towards the processor, this indicates that the pin is configured as an input. Conversely, if the arrow points away from the processor, this indicates that the pin is configured as an output.

Figure 24.6 Processor Pins Window

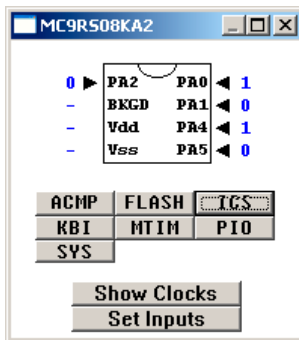

Below the graphical processor representation are several buttons, each corresponding to a processor peripheral. Pressing the button of a given peripheral brings up the appropriate register files (see below), allowing for easy and informative manipulation of all status, control, and data bits associated with a peripheral.

At the bottom of the dialog box are two additional buttons. The **Show Clocks** button brings up the simulated clock frequencies. The **Set Inputs** button brings up the Inputs dialog box, which allows the user to set the simulated input buffers to any valid value.

Run Till Cycle Command

This menu option, which corresponds to the GOTOCYCLE command, brings up an input dialog box which allows the user to specify a given cycle value. When the master cycle counter for the simulator reaches the input value, simulation halts.

Figure 24.7 Run Till A Specific Cycle Dialog Box

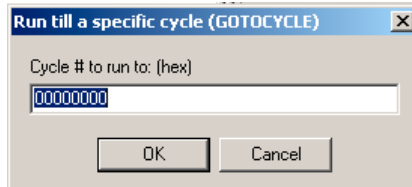

View Register Files Command

The **View Register Files** selection in the RS08FCS menu also gives the user the option of running the register file viewer/editor. If register files are available for the device that you have chosen, the **Choose a Register Block** window (see [Figure 24.8](#)) opens. You may also open it by entering the R command in the Command Window command line.

Figure 24.8 Choose A Register Block Dialog Box

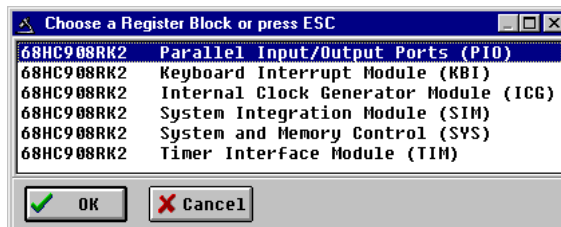

If register files have been installed on the host computer, selecting a block brings up the Register Block register listing (see [Figure 24.9](#)), which shows a list of the files, their addresses, and their descriptions. This begins interactive setup of system registers such as I/O, timer, and COP watchdog.

RS08 Full Chip Simulation

Peripheral Modules Commands

Figure 24.9 Timer Interface Module Register Listing

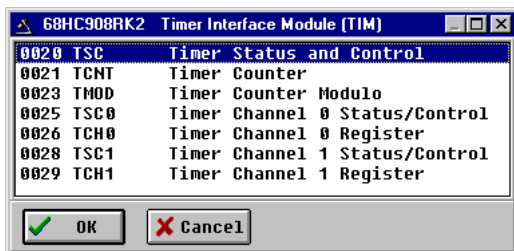

Selecting a file brings up the Register Window (see [Figure 24.10](#)), which displays the value and significance of each bit in the register. The registers can be viewed and their values modified, and the values can be stored back into debugger memory.

Figure 24.10 Register Window

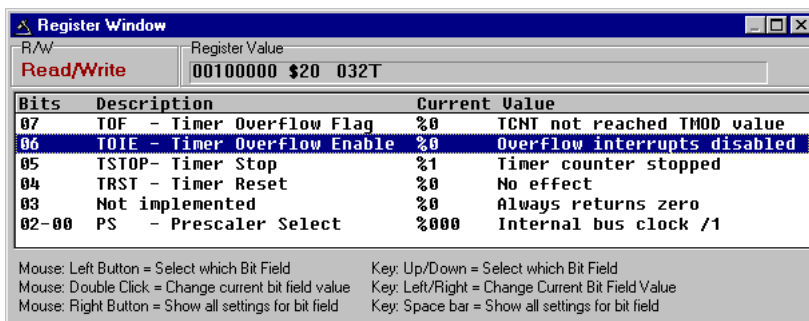

Peripheral Modules Commands

When you select a device (see [Device Option](#)), the RS08FCS Menu displays a list of peripheral modules and the associated commands for the device you have chosen.

RS08 P&E Multilink/Cyclone Pro Connection

The RS08 P&E Multilink/Cyclone Pro Connection setting permits a connection to Multilink/Cyclone Pro devices. RS08 P&E Multilink/Cyclone Pro connection mode allows the user to debug code, as the firmware is fully resident in the FLASH of the microprocessor. The operation of all modules fully reflects the actual operation of the on-board resources.

Connection Procedure

To select the P&E Multilink/Cyclone Pro as your debugger connection:

1. Choose the P&E Multilink/Cyclone Pro option from the Set Connection dialog box as shown in [Figure 25.1](#).
2. Click the OK button.

Figure 25.1 Set Connection Dialog Box

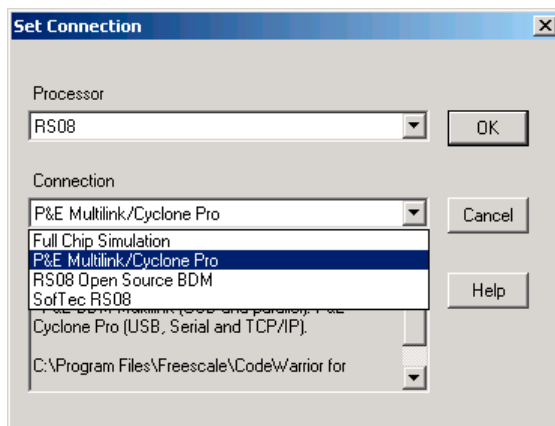

3. Choose the P&E device that you are using from the Interface list menu and click on *Refresh List*. See [Figure 25.2](#) and [Figure 25.3](#).

RS08 P&E Multilink/Cyclone Pro Connection Connection Procedure

Figure 25.2 RS08 Connection Assistant Interface Selection

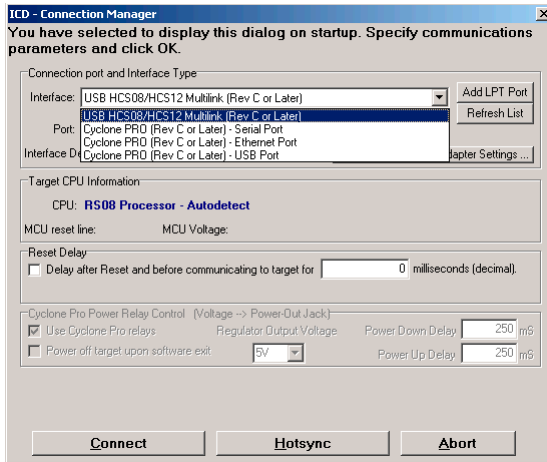
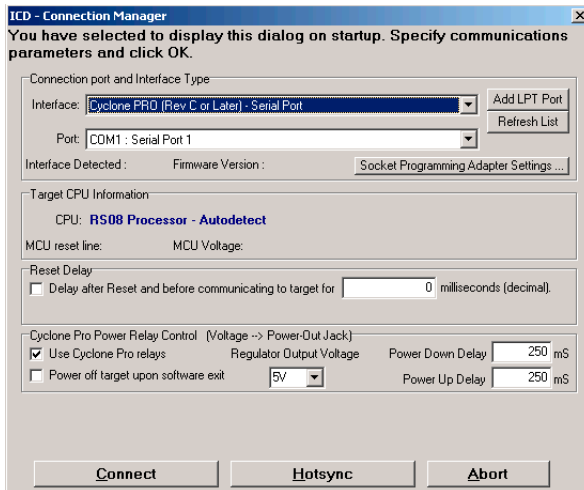

Figure 25.3 RS08 Connection Assistant Interface Selected



Hotsync Button

The **Hotsync** button in the Connection Assistant (see [Figure 25.3](#)) allows the user to connect to an already running target.

MultilinkCyclonePro Menu Description

When you have selected P&E Multilink/Cyclone Pro as your connection, the Connection menu's name is changed and other options are added.

Figure 25.4 Connection (MultilinkCyclonePro) Menu

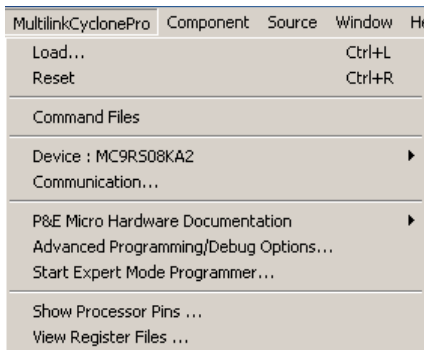

Device Option

The Device option in the MultilinkCyclonePro menu allows the user to select the particular Freescale processor that they wish to use. Select Device from the MultilinkCyclonePro menu to display a submenu that allows you to select the family (e.g. KA Family), and device type (e.g. MC9RS08KA2) of the MCU that you are using.

Figure 25.5 RS08 Device Extended Menu

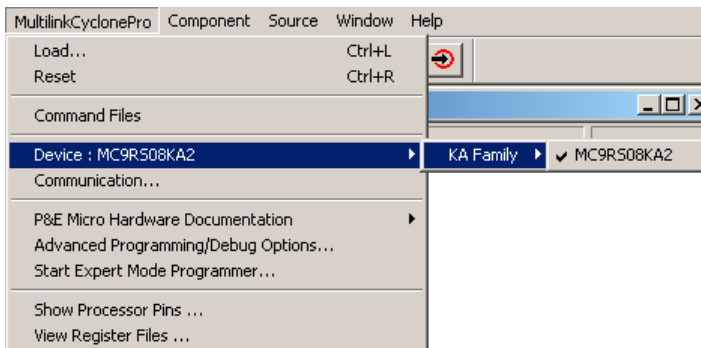

Connect Option

The Connect option initiates an attempt to communicate with the device chosen under the Device section of the menu.

Active Mode Menu Options

When the microprocessor is connected, more Connection Menu options become available to the user.

Figure 25.6 Additional Connection Menu Options

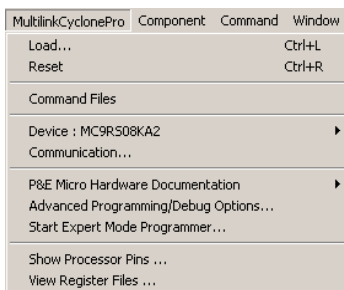

Advanced Programming/Debug Options

The Advanced Programming/Debug Options menu option takes you to the Advanced Options dialog box, where you can configure the software settings for the FLASH programming procedure.

Figure 25.7 Advanced Options Dialog Box

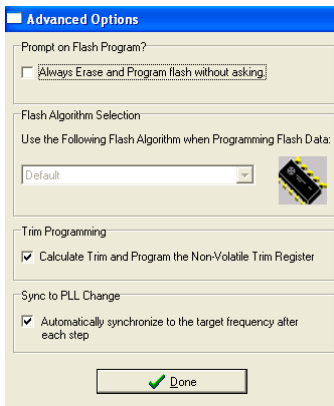

Prompt on Flash Program Checkbox

Checking **Always Erase and Program Flash without asking** in this dialog box lets the software transparently program the microprocessor.

Trim Programming Checkbox

The **Trim Programming** checkbox enables automatic calculation and programming of the trim value in a designated non-volatile memory location.

Sync to PLL Change Checkbox

Sync to PLL Change is required for the software/hardware connection to synchronize with the microprocessor during the Flash erasing/programming procedure.

Start Expert Mode Programmer Option

The *Start Expert Mode Programmer* option in the Connection Menu grants the user access to P&E's graphical Flash programming utility, PROGRS08. PROGRS08 lets an advanced user control the step-by-step execution of the Flash erase/programming procedure. See [Figure 25.8](#). More information on how to use the PROGRS08 can be found on the P&E Microcomputer Systems website at www.pemicro.com.

Figure 25.8 PROGRS08 Programmer Window

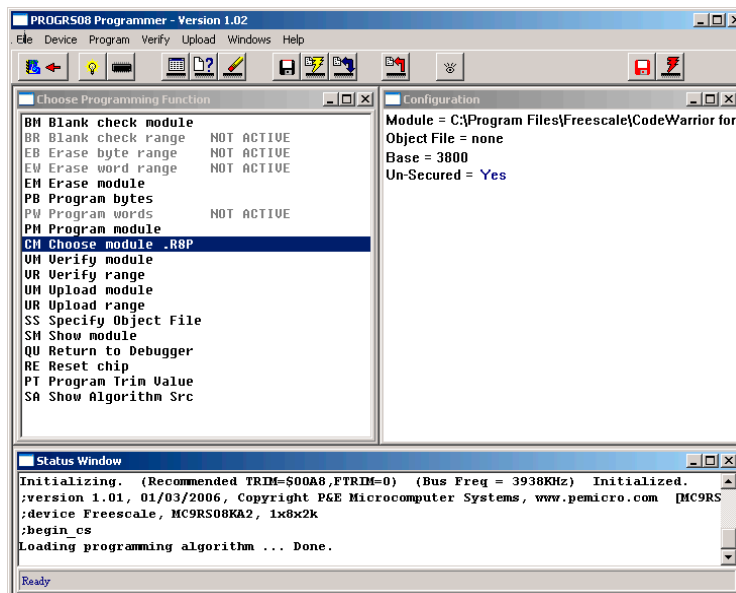

Show Processor Pins

The Processor Pins dialog box is a convenient tool for monitoring the current state of the processor pins, as well as the peripheral with which a pin may be associated. The processor is represented, in graphical form, in the middle of the dialog box. Each pin is labeled with its current function. For example, Pin 2 is the BKGD pin upon reset. However, with the appropriate write to the SOPT register, the user can observe that Pin 2 changes to PTA3 in the Processor Pins dialog box.

In the dialog box, each processor pin (with the exception of the power pins, Vdd and GND) has a corresponding arrow. If the arrow points towards the processor, this indicates that the pin is configured as an input. Conversely, if the arrow is pointing away from the processor, this indicates that the pin is configured as an output.

Figure 25.9 Processor Pins Window

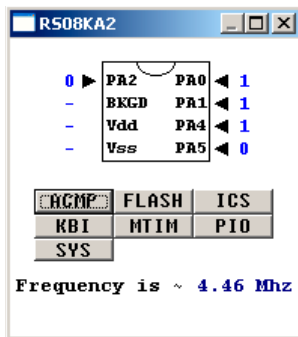

Below the graphical processor representation are several buttons, each corresponding to a processor peripheral. Pressing the button of a given peripheral brings up the appropriate register files (see below), allowing for easy and informative manipulation of all status, control, and data bits associated with a peripheral.

At the bottom of the dialog box is a reading of the current processor speed. This is measured on the device itself, and is a real-time indication of the current bus speed of the processor.

View Register Files Option

The *View Register Files* Connection menu selection also gives the user the option of running the register file viewer/editor. If register files are available for the device that you chose, the *Choose a Register Block* window (see [Figure 25.10](#)) opens. You may also open it by entering the R command in the Command Window command line.

Figure 25.10 Choose A Register Block Window

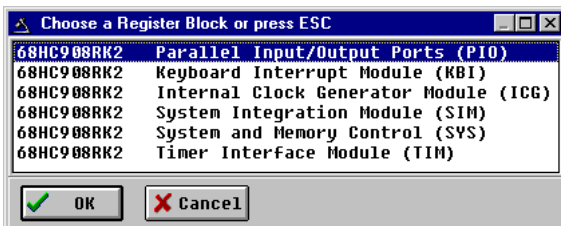

If register files have been installed on the host computer, selecting a block brings up the Register Block register listing (see [Figure 25.11](#)), which shows a list of the associated registers, their addresses, and their descriptions. This begins the interactive setup of system registers such as I/O, timer, and COP watchdog.

Figure 25.11 Register Block Register Listing

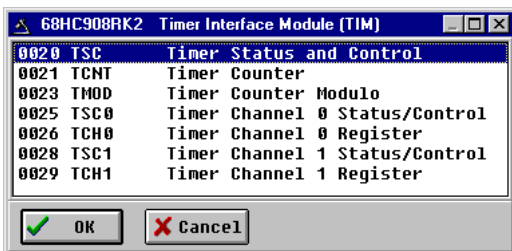

Selecting a file brings up the Register Window (see [Figure 25.12](#)), which displays the values and significance for each bit in the register. The registers can be viewed and their values modified, and the values can be stored back into debugger memory.

Figure 25.12 Register Window

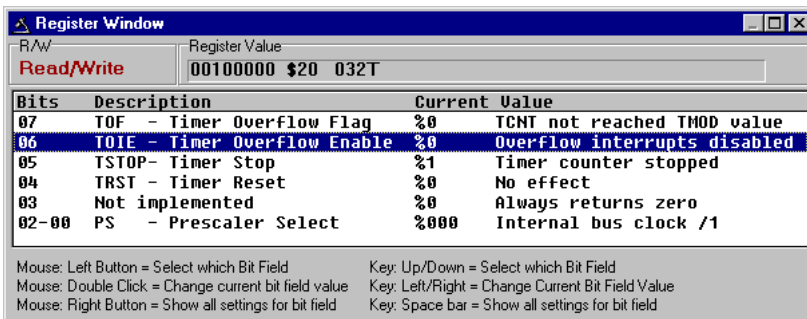



RS08 P&E Multilink/Cyclone Pro Connection

Connection Procedure

RS08 Open Source BDM Connection

This chapter guides you through the first steps toward debugging with the CodeWarrior IDE and the *RS08 Open Source BDM* connection. It does not replace all the additional documentation provided in this manual, but gives you a good starting point.

RS08 Open Source BDM Technical Considerations

The 8/16 bits debugger (and then the CodeWarrior IDE) can be connected to RS08 hardware using the RS08 OSBDM (Open Source BDM) cable.

When the debugger runs the **RS08 Open Source BDM** connection, it can communicate and debug **RS08** core based hardware connected through the *Open Source BDM Interface*; as described on the Freescale Semiconductor web site: <http://www.freescale.com> (keyword: OSBDM08).

CodeWarrior IDE and RS08 Open Source BDM Connection

There are two separate paths that may be followed to take the first steps toward debugging with the CodeWarrior IDE and the RS08 Open Source BDM connection. The differences between the two paths hinge on the starting point for the steps:

- Using the Stationary Wizard at the start of the project
- From within an existing project

First Steps Using the Stationery Wizard

To take the first steps toward debugging with the CodeWarrior IDE and the RS08 Open Source BDM using the stationery Wizard:

1. Run the CodeWarrior IDE
2. In the *Microcontrollers New Project Wizard*, follow the path to create a new project and name the project.
3. Click the Next button to open the New Project window.
4. In the Microcontrollers New Project window, select the RS08 Family chip you are working with from the list in the Derivative list box.

Figure 26.1 Microcontrollers New Project Wizard Window

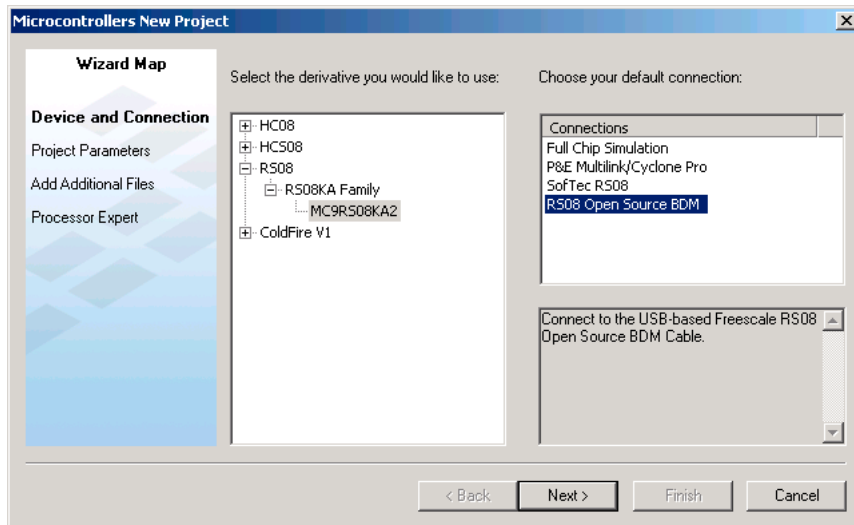

5. From the Default Connection list box, choose the connection **RS08 Open Source BDM** to create a new project from this stationery.
6. Click the Finish button - the CodeWarrior IDE opens.
7. Choose the menu option *Project > Make*.
8. Choose the menu option *Project > Debug* to start the debugger.
9. Start debugging.

First Steps From Within an Existing Project

To take the first steps toward debugging with the CodeWarrior IDE and setting the RS08 Open Source BDM connection from within an existing debugging project:

1. Run the CodeWarrior IDE.
2. Open the project.
3. Choose *Project > Debug* to start the debugger.
4. In the debugger main window, choose *Component > Set Connection* to select another connection.
5. Select **RS08** as the Processor then **RS08 Open Source BDM** as the connection.

Figure 26.2 Set Connection Dialog Box - RS08 Open Source BDM Selection

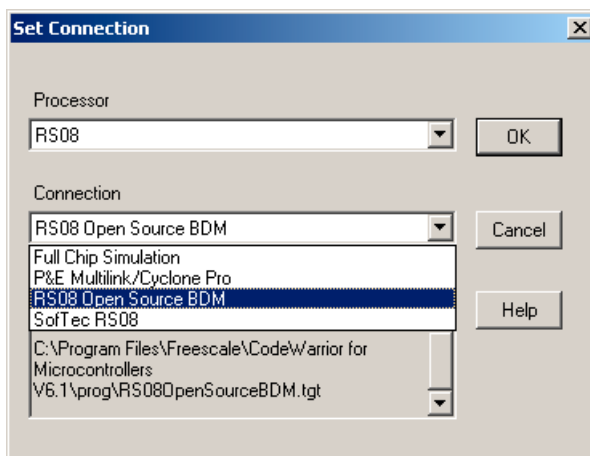

6. Click the OK button - Set Derivative dialog box typically opens (if not, you can start debugging immediately).
7. In the Set Derivative dialog box, select your target processor.

RS08 Open Source BDM Connection

First Steps From Within an Existing Project

Figure 26.3 MCU Configuration Dialog Box

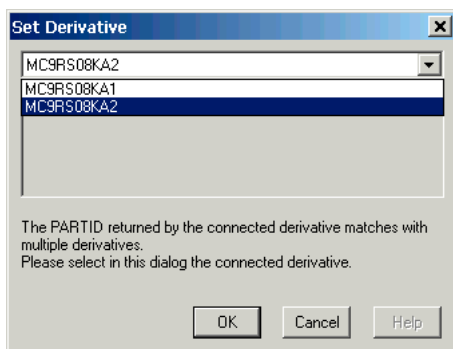

8. Select the *OK* button to start debugging.

RS08 Open Source BDM Menu Options

Once the RS08 Open Source BDM connection is set, the connection menu entry in the debugger main toolbar changes to **RS08 Open Source BDM**.

Figure 26.4 RS08 Open Source BDM Menu Options

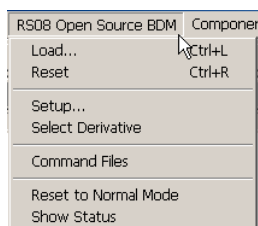

Setup Option

Select *RS08 Open Source BDM* > *Setup* to display the [RS08 Open Source BDM Setup Dialog Box](#).

Select Derivative Option

Select *RS08 Open Source BDM* > *Select Derivative* to display the [Select Derivative Dialog Box](#).

NOTE If there is only one derivative recognized by the debugger, this menu entry is not available.

Reset to Normal Mode Option

Select *RS08 Open Source BDM > Reset to Normal Mode* to reset the hardware CPU to normal mode.

Show Status Option

Select *RS08 Open Source BDM > Show Status* to display the [Show Status Dialog Box](#).

RS08 Open Source BDM Setup Dialog Box

This dialog box is used to set up your communication device. The communication device list menu shows the current OSBDM cables plugged into the computer.

Figure 26.5 RS08 Open Source BDM Setup Dialog Box

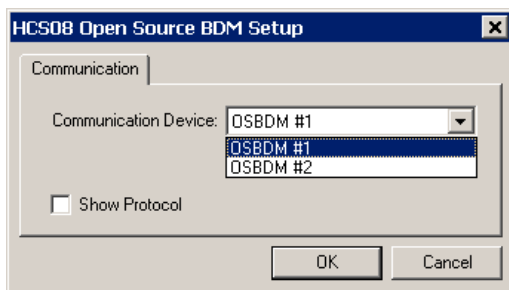

Select the OSBDM cable, then click the *OK* button to start debugging.

The Show Protocol checkbox and option is for Support usage only. When enabled, debugger internal information is reported in the Command window.

TIP Cables are enumerated #1, #2, etc. in the order they have been plugged into the computer USB hub.

Select Derivative Dialog Box

This dialog box is a derivative setup dialog box. The list menu gives a list of derivatives that match the target silicon System Device Identification Registers (SDIDH, SDIDL).

Figure 26.6 Select Derivative Dialog Box

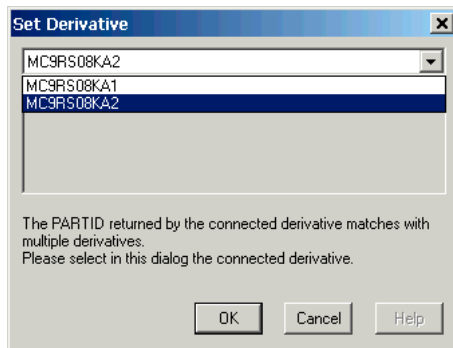

Select the correct target hardware derivative then select the *OK* button to start debugging.

Show Status Dialog Box

This dialog box provides both a revision summary of the RS08 Open Source BDM software and hardware, plus technical support information.

Figure 26.7 Show Status Dialog Box

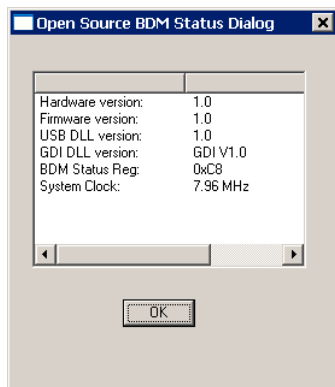

Select the *OK* button to close this dialog box.

SofTec RS08 Connection

This section guides you through the first steps toward debugging with the CodeWarrior IDE and the *SofTec RS08* connection.

SofTec RS08 Technical Considerations

The 8/16 bit debugger (and then the CodeWarrior IDE) might be connected to RS08 hardware using the SofTec RS08.

When the debugger runs the **SofTec RS08** connection, it can communicate and debug **RS08** core based hardware connected through the SofTec in-circuit debugger/programmer units, such as:

SofTec Microsystems HCS08 ISP Debuggers/Programmers (inDART Series) and Starter Kits (PK and newer Series).

Refer to the *inDART®-HCS08 In-Circuit Debugger/Programmer for Motorola HCS08 Family FLASH Devices User's Manual* from SofTec for communication hardware requirements and SofTec product installation.

CodeWarrior IDE and SofTec RS08 Connection

There are two separate paths that may be followed to take the first steps toward debugging with the CodeWarrior IDE and the SofTec inDART-RS08 connection. The differences between the two paths hinge on the starting point for the steps:

- Using the Stationary Wizard at the start of the project
- From within an existing project

SofTec RS08 Connection

First Steps Using the Stationery Wizard

First Steps Using the Stationery Wizard

To take the first steps toward debugging with the CodeWarrior IDE and the SofTec inDART-RS08 using the stationery Wizard:

1. Run the CodeWarrior IDE with the shortcut created in the program group.
2. In the *Microcontrollers New Project Wizard*, follow the path to create a new project, naming the project.
3. Click the *Next* button to open the New Project window.
4. In the *Microcontrollers New Project* window, select the RS08 Family chip you are working with from the list in the Derivative list box in the left of the window.

Figure 27.1 Wizard Connection Selection

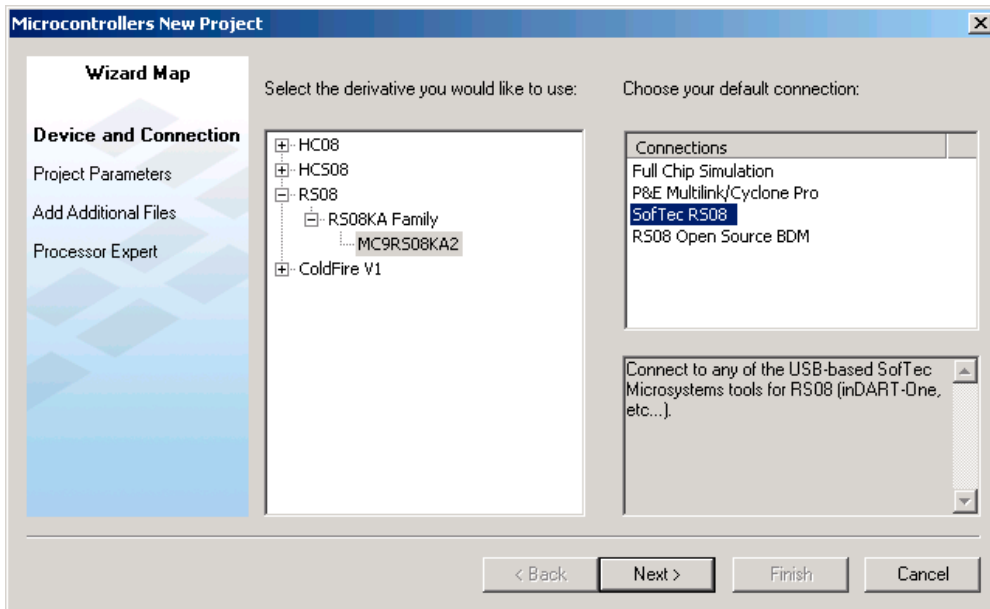

5. From the Default Connection list box, choose the connection **SofTec RS08** to create a new project from this stationery.
6. Click the *Finish* button - IDE opens as shown in [Figure 27.2 on page 569](#).

Figure 27.2 IDE Main Window - Project Menu

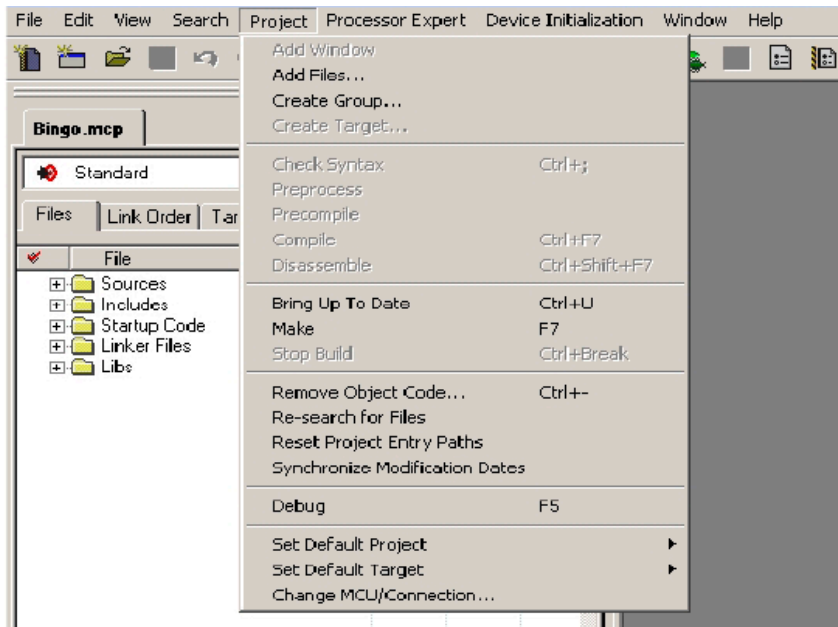

7. Choose the menu option *Project > Make*.
8. Choose the menu option *Project > Debug* to start the debugger.
9. Start debugging.

SofTec RS08 Connection

First Steps From Within an Existing Project

First Steps From Within an Existing Project

To take the first steps toward debugging with the CodeWarrior IDE and setting the SofTec RS08 connection from within an existing debugging project:

1. Run the CodeWarrior IDE with the shortcut created in the program group.
2. Open the project.
3. Choose the menu *Project > Debug* to start the debugger.
4. Choose in the debugger menu *Component > Set Connection* to select another target interface in the Set Connection dialog box.
5. Select **RS08** as the Processor then **SofTec RS08** as the connection.

Figure 27.3 Set Connection Dialog Box - SofTec RS08 Selection

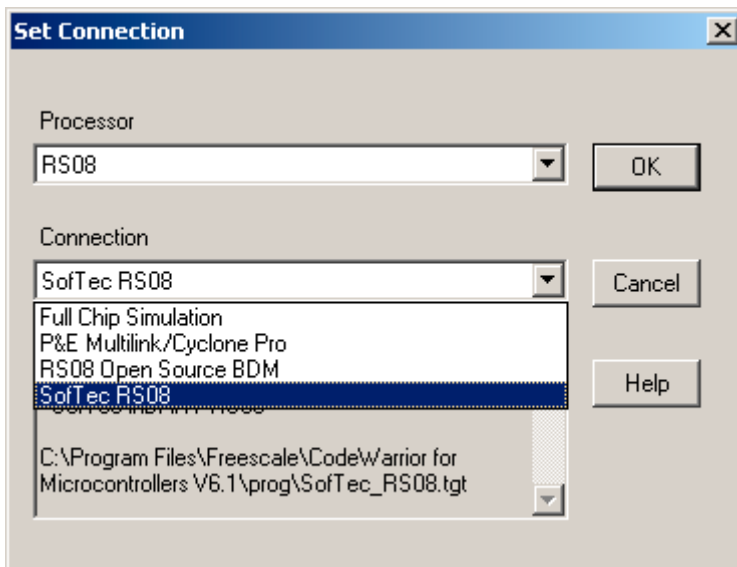

6. Press the OK button - MCU Configuration dialog box opens.
7. In the MCU Configuration dialog box, choose the correct target processor.

Figure 27.4 MCU Configuration Dialog Box

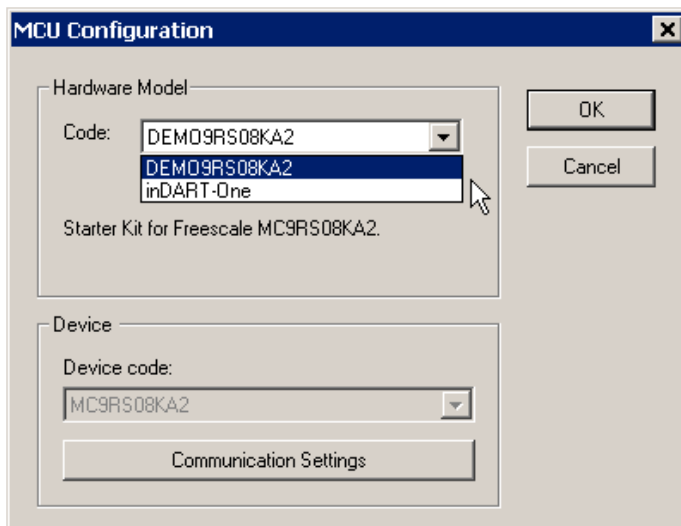

8. Press the OK button to start debugging.

SofTec RS08 Menu Options

Once the *SofTec RS08* connection is set, the connection menu entry in the debugger main toolbar is set to *SofTec-RS08*.

Figure 27.5 SofTec-RS08 Menu Options

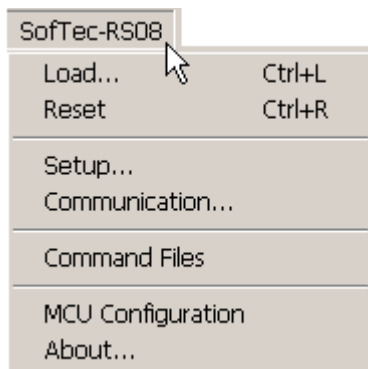

SofTec RS08 Connection

First Steps From Within an Existing Project

MCU Configuration Option

Select *SofTec-RS08 > MCU Configuration* to display the MCU Configuration dialog box.

About Option

Select the *SofTec-RS08 > About* option to display the About dialog box.

MCU Configuration Dialog Box

The *Hardware Model* list menu can be expanded to select another type of BDC debug interface than the SofTec inDART-RS08. The *HW Code* list menu can be expanded to select another RS08 derivative.

Figure 27.6 MCU Configuration Dialog Box

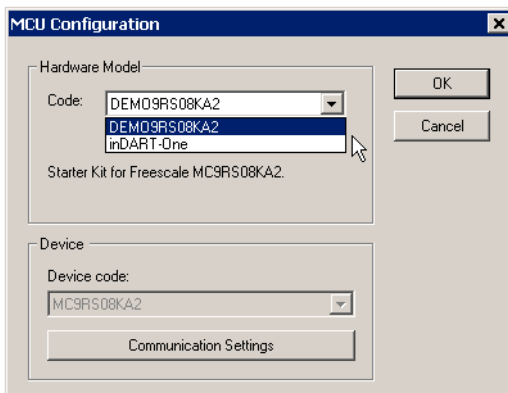

Pressing the *Communication Settings* button in this window opens the Communication Settings dialog box.

Communication Settings Dialog Box

The communication dialog box provides chip trimming. The *Enable Trimming* checkbox can be checked to enable the trimming data calculation according to the requested DCO value that can be specified in the *DCO Output Frequency (Hz)* edit box. The trimming data is then programmed automatically at application loading time at specified locations (*Flash Trimming locations*).

Refer to the *inDART®-HCS08 In-Circuit Debugger/Programmer for Motorola HCS08 Family FLASH Devices User's Manual* from SofTec for further details.

Figure 27.7 Communication Settings Dialog Box

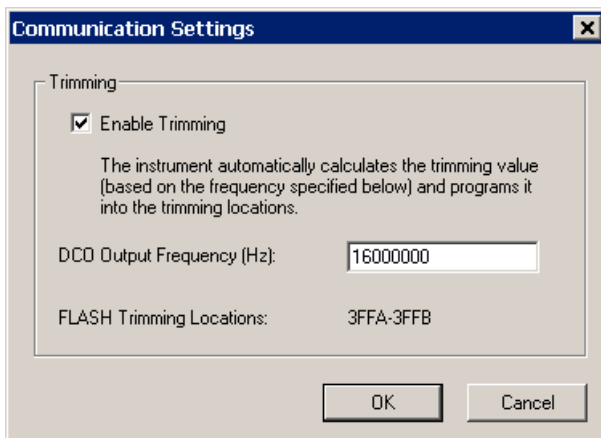

About Dialog Box

This dialog box belongs to the SofTec GDI DLL and provides information about the SofTec_BDC08.dll release and version.

Figure 27.8 About Dialog Box





SofTec RS08 Connection

First Steps From Within an Existing Project

Book V - ColdFire® V1.0 Debug Connections

Book V Contents

Each section of the Debugger manual includes information to help you become more familiar with the Debugger, to use all its functions and help you understand how to use the environment.

Book 5 is divided into the following chapters:

- [ColdFire V1 Full Chip Simulation Connection](#)
- [ColdFire P&E Multilink/Cyclone Pro Connection](#)
- [SofTec ColdFire Connection](#)
- [ColdFire On-Chip DBG Module](#)



Book V Contents

ColdFire V1 Full Chip Simulation Connection

The Full Chip Simulation (FCS) connection runs a complete simulation of all processor peripherals and I/O on the user's Personal Computer. No development board is required. Each derivative has a unique simulation engine to accurately simulate the memory ranges, I/O, and peripherals for a given derivative (for more information on selecting a specific derivative, see the FCS and Silicon On-Chip Peripheral Simulation sections).

This section presents the first steps to debugging using the CodeWarrior debugger and the ColdFire V1 Full Chip Simulation connection.

Full Chip Simulation Menu

[Figure 28.1](#) shows the menu associated with the Full Chip Simulation connection. Use this menu to load an application that uses FCS. [Table 28.1](#) describes the FCS menu entries.

 **Figure 28.1 ColdFire FCS Menu**

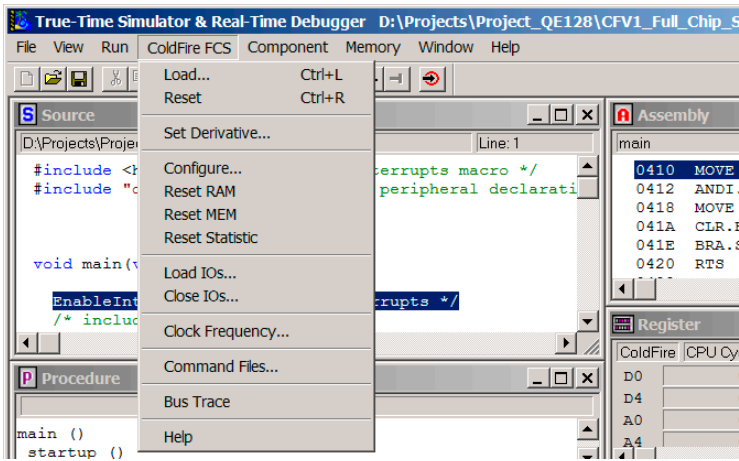

ColdFire V1 Full Chip Simulation Connection

Table 28.1 Simulator Menu Entry Description

Menu Entry	Description
Load	Opens the Load Executable Window menu.
Reset	Resets the Full Chip Simulation.
Set Derivative	Selects the current simulated derivative.
Configure	Opens the Memory Configuration Window.
Reset RAM	Resets the RAM to undefined
Reset Mem	Resets all configured memory to undefined
Reset Statistic	Resets the statistical data
Load I/Os	Opens I/O components
Close I/Os	Closes I/O components
Clock Frequency	Opens the Clock Frequency Setup dialog box to set the Real Time clock.
Command Files	Opens the Command Files Window
Bus Trace	Opens the Bus Trace dialog box to enable instructions and memory access recording and to display recording captures.
Select Core	Selects the processor core. 

Debugger Status Bar with Full Chip Simulation

The status bar ([Figure 28.2](#) and [Figure 28.3](#)) shows status and other information. As well as execution status, it includes a context-sensitive menu help line, and connection-specific information such as the number of CPU cycles (64 bits), or the elapsed time in hours:minutes'seconds"milliseconds (float) format since the application started.

Figure 28.2 Debugger Status Bar with CPU Cycles

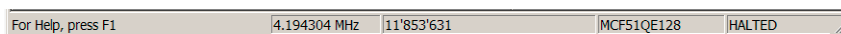
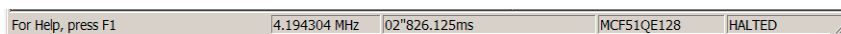

Figure 28.3 Debugger Status Bar with Elapsed Time



The status bars show the selected simulated derivative or simulated CORE or core SAMPLE and the current derivative CPU frequency in MHz.

NOTE Clicking on the CPU frequency opens the [Clock Frequency Setup](#).

NOTE Double-clicking on the CPU cycles or true time resets the value.

NOTE Clicking on the displayed derivative, CORE, or core SAMPLE opens the Set Derivative dialog box.

Open I/O Component Dialog Box

From the Simulator menu, choose **Load I/Os** to open the **Open I/O Component** dialog box. This dialog box, shown in [Figure 28.4](#), allows you to open an **I/O** device (peripheral) simulation. The **Browse** button allows you to specify a location for the **I/O**.



Figure 28.4 Open IO Component Dialog Box

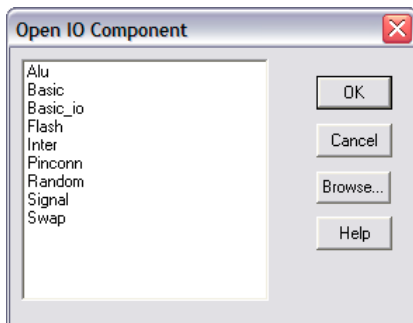

NOTE I/O simulation components are either designed by Freescale and delivered with the tool-kit installation or designed by the user with the Peripheral Builder, a separate product.

Demo Version Limitations

There are no limitations in the Demo Version.

Command Files Window

[Figure 28.5](#) shows the FCS connection Command Files window.



Figure 28.5 Full Chip Simulation Connection Command Files Window

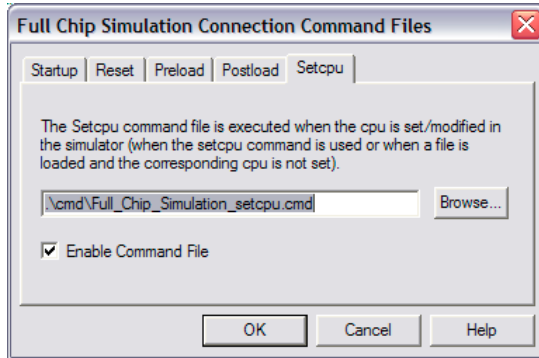

Setcpu Command File

The **Setcpu** command file is specific to FCS and the Debugger executes the command file after a CPU has been set or modified. This occurs when you use the `setcpu` command or when you load an application in the FCS when the corresponding CPU is not set.

You can specify the **Setcpu** command file full name and status (enable/disable) either with the **CMDFILE SETCPU** Command Line command or by using the **Setcpu** property tab of the connection Command Files dialog.

The default **Setcpu** command file is `SETCPU.CMD`. By default the `SETCPU.CMD` file located in the current project directory is enabled as the current **Setcpu** command file.

Memory Configuration

The memory configuration interface is an FCS advanced configuration feature. The FCS divides the emulated memory into blocks. A memory manager handles the list of memory blocks. The memory configuration facility offers you some degree of automation, but does not restrict the flexibility of manual adjustment. The memory configuration facility lets you specify types and properties of memory blocks, such as RAM and ROM.

The memory configuration facility uses a binary file format to read and set the FCS configuration. The extension for binary files is `.mem`; the default memory file is `default.mem`. (The subsection [TestTerm Component](#) includes [Listing 28.2](#), the EBNF-syntax definition of the file format.)

Memory Configuration Dialog Box Features

The memory configuration dialog box ([Figure 28.6](#)) lets you perform these memory-block operations interactively:

- Select the configuration mode for simulation
- Define a memory block name
- Define how the Full Chip Simulation verifies the memory
- Set the type of the memory: RAM, ROM, Flash, EEPROM or I/O
- Define start and end addresses
- Define the wait state (the time for each read or write access)
- Set the width of the bus that accesses the memory
- Set access details such as:
 - *auto configure*: automatically computing read and write access
 - *misaligned access*: allowing misaligned access on words and longs
- Open and save memory configuration
- Add, delete, or update memory blocks

Figure 28.6 Memory Configuration Dialog Box

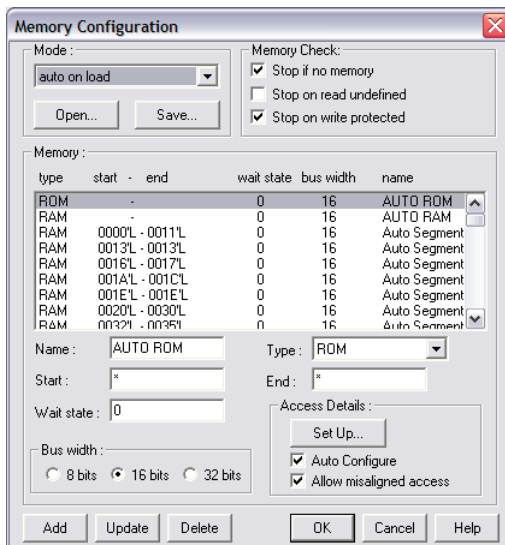

Memory Configuration Modes

Use the **Memory Configuration** dialog box to select the memory configuration mode: **auto configuration on access**, **auto configuration on load**, or **manual configuration (user defined)**. Depending on your settings, the FCS component initializes the FCS memory as [Table 28.2](#) explains.

Table 28.2 Memory Configuration Modes

Mode	Description
Auto Configuration on Access (Standard Configuration)	Defines the FCS memory as RAM of unlimited size. The <i>Mode</i> combo box displays <i>auto on access</i> .
Auto Configuration on Load (default)	Defines the FCS memory as RAM and ROM, according to the code and data area defined in a loaded absolute file. Defines code segments as ROM. Defines data segments as RAM. (Memory outside these segments is <i>not implemented</i> ; access to unimplemented locations result in error messages.) The <i>Mode</i> combo box displays <i>auto on load</i> .
Manual Configuration (User Defined)	Defines the FCS memory as RAM, ROM, or non-volatile RAM, depending on your configuration. You construct this definition interactively with the Memory Configuration dialog box, or read it in from a file. The <i>Mode</i> combo box displays <i>user defined</i> .

Memory Configuration Settings

Depending on the configuration mode, the Memory Configuration dialog box lets you redefine memory settings within certain limits. You must always set I/O devices manually.

Standard Configuration: Auto on Access: The Memory Configuration dialog box contains a single RAM entry with unspecified (*) starting and ending addresses. You cannot modify these addresses. You can adjust wait states, and other such settings, only for the whole RAM block.

Auto Configuration on Load: Initially, the dialog box lists a single RAM and a single ROM block, with unspecified (*) starting and ending addresses. You can adjust wait states and other settings separately for RAM and ROM blocks.

For the ELF/DWARF Object file format, the Memory Configuration dialog box lists separate RAM and ROM blocks for each data and code segment in the absolute file, once an application has been loaded. The segment addresses and lengths determine the starting and ending addresses of each block; you cannot modify these addresses. Initial attributes of each code and data block come from the corresponding initial RAM and ROM blocks; you can modify these attributes independently.

Manual Configuration: The Memory Configuration dialog box lists an entry for each memory block. You can modify such entries without restriction.

NOTE To simulate an absolute file generated in Freescale object file format, you must open the Memory Configuration dialog box, set the **auto on load** mode, then add a new RAM segment. The start and end addresses of this segment must match the associated `.prm` file. Once you close the dialog box, you can load your application and start a simulation.

Open Memory Block

Click the **Open** button to load a memory block file. The **Open Memory blocks** standard dialog box appears. Select a memory map file, then click the **OK** button. The dialog box closes, and the system loads the memory block file.

The *Mode* combo box changes to indicate the mode contained in the memory map file.

The list box lists the memory blocks loaded from the file, starting from the first memory block. Appropriate data appears in the fields **Name**, **Type**, **Start**, **End**, **Wait state**, **Bus width** and **Access Details**.

Save Memory Block

Click the **Save** button to store the current memory blocks configuration. The **Save Memory blocks** standard dialog box appears. Enter a file name, then click the **OK** button. The dialog box closes, and the system stores the memory block configuration into the file.

Memory Check Options

The Memory Check group box consists of three checkboxes, all checked when you bring up the Memory Configuration dialog box:

- Stop if no memory — Check this box to have the FCS stop on an access to non-existent memory. Clear this checkbox to prevent the FCS from stopping.
- Stop on read undefined — Check this box to have the FCS stop on a read of undefined memory. Clear this checkbox to prevent the FCS from stopping.
- Stop on write protected — Check this box to have the FCS stop on a write to read-only (write-protected) memory. Clear this checkbox to prevent the FCS from stopping.

Memory Configuration Module Startup

Memory configuration is a *dynamically loaded* facility. That is, the new entry **Configure** appears in the *Simulator* menu upon loading of the FCS (the Full Chip Simulation dll). Selecting **Configure** opens the **Memory Configuration** dialog box, so that you can configure memory.

Memory Block Setting

You must set memory blocks within the available memory; each block must cover a certain range. The *start address* and *end address* define each memory block.

Memory Block Properties

[Table 28.3](#) lists the properties you may specify for a memory block:

Table 28.3 Memory Block Properties

Item	Description
Name	Name of the memory block.
Type	RAM, ROM, Flash, EEPROM or I/O
Start	Start address of the memory block
End	End address of the memory block
Wait state	Time used for reading or writing a specific number of bytes
Bus width	Width of the bus that accesses the memory
Read access	Table that defines read-access details on Byte, Word, Word misaligned, Long, and Long misaligned
Write access	Table that defines write-access details on Byte, Word, Word misaligned, Long, and Long misaligned
Auto configure	Flag that directs automatic computation of read and write accesses
Allow misaligned access	Flag that allows Word misaligned and Long misaligned
Block type	USER_DEF (block you define), AUTO_GEN (block automatically generated), AUTO_MEM (master block for standard configuration), AUTO_RAM (RAM master block for auto configuration), or AUTO_ROM (ROM master block for auto configuration)

Memory Configuration Dialog Box Command Buttons

The Memory Configuration dialog box contains these command buttons:

- **Add** — Fills a new memory block according to the current data of the **Name**, **Type**, **Start**, **End**, **Bus width**, and **Access Details** controls. This new memory block appears at the end of the list box. If there are any errors in this new block (such as an improper field value), the system generates a message box that informs you of the problem.
- **Update** — Updates the current memory block according to the current data of the **Name**, **Type**, **Start**, **End**, **Bus width**, and **Access Details** controls.
- **Delete** — Removes the currently selected memory block from the list box. The list box contents adjust to reflect this deletion.
- **OK** — Closes the dialog box and validates the list of modified memory blocks. The parent class can access this list, updating its own list.
- **Cancel** — Closes the dialog box, canceling your modifications.
- **Help** — Opens the dialog-box help file.

Access Details Dialog Box

[Figure 28.7](#) shows the **Access Details** dialog box, which lets you change read and write access values for seven types.

Figure 28.7 Memory Configuration Dialog Box - Access Details Dialog Box

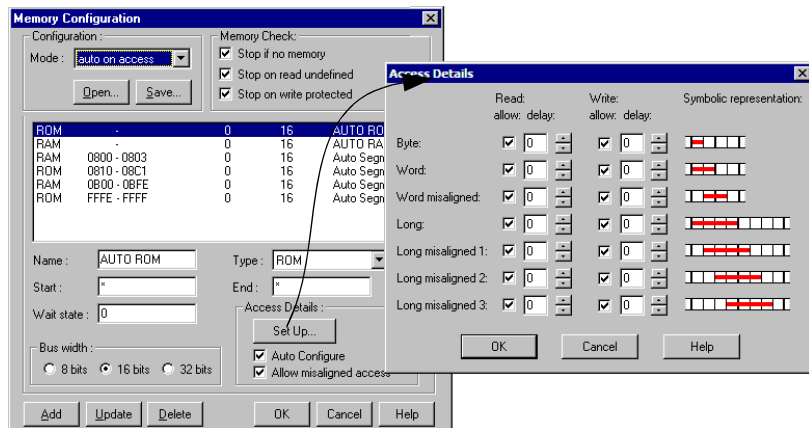

Follow this guidance to use the **Access Details** dialog box:

- A check box indicates whether an access kind is allowed.

ColdFire V1 Full Chip Simulation Connection

- To modify the value of each read or write type, change the value of the associated spin box.
- The lowest possible value is 0.
- The highest possible value is 127.
- To store changes into the currently selected memory block, click the **OK** button. The **Access Details** dialog box disappears, and the system clears the **Auto Configure** checkbox.
- To abandon your changes, click the **Cancel** button. The **Access Details** dialog box disappears and the system discards your changes.
- To bring up appropriate help information, click the **Help** button.

Output

You can save the current memory configuration into the file you defined at the outset.

Clock Frequency Setup

The Full Chip Simulation provides a **true time information**. It is possible to provide an oscillator clock frequency to the debugger. The debugger CPU awareness and IO modules provide the "clock factor" to apply to this input frequency to derive the CPU cycle frequency.

Figure 28.8 Clock Frequency Setup Dialog Box

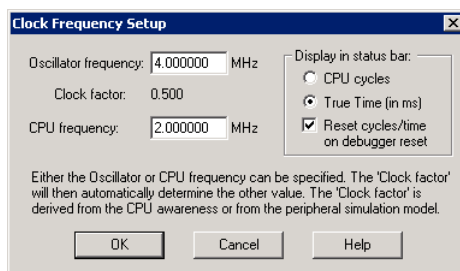

Derivative-specific IO simulations which require bus speed change information (multiply or divide) from the PLL modules update the clock factor while the application simulation is running.

This does not affect the accumulated elapsed time, and applies a new cycle time to the next simulated instructions in real time.

Open the Clock Frequency Setup dialog (**Simulator > Clock Frequency**) to set, enter, or edit either the oscillator frequency or the CPU frequency. However, the saved project

frequency is always the **oscillator** frequency. Two radio buttons allow you to choose between cycles or true-time display in debugger status bar.

Clearing **Reset cycles/time** makes the debugger accumulate cycles/time other than CPU reset. The true-time unit is the microsecond. The TRUETIME debugger command line command gives the time as a number in microseconds. The OSCFREQUENCY variable displays or sets the oscillator frequency.

Bus Trace

The FCS can record all executed instructions and memory accesses in the Trace component, up to one million frames. Enable recording in the Trace menu or context-sensitive menu after opening the Trace component.

NOTE Refer to the *ColdFire On-Chip DBG Module* manual for the Trace Component Window common functionality and common menu entries.

Figure 28.9 Trace Window Context Menu

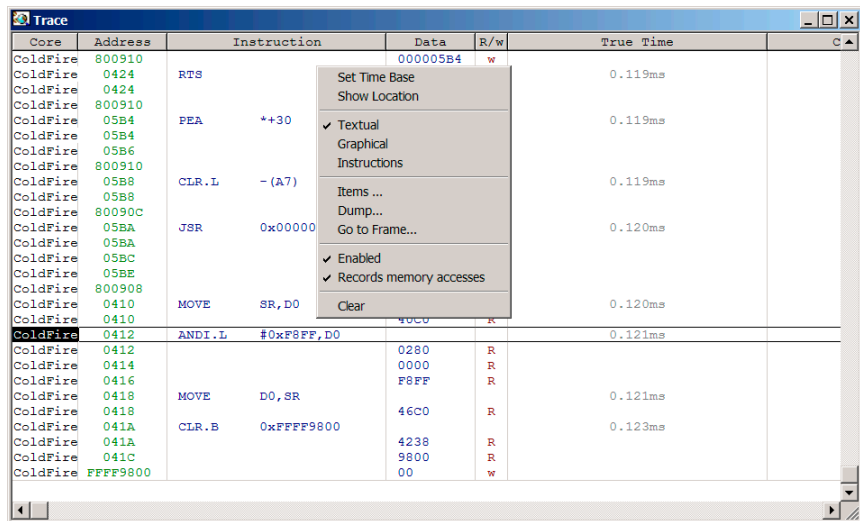

By default, FCS records instructions only (faster). Check **Record memory accesses** and choose **Textual** mode in the Trace menu or context-sensitive menu to record memory accesses as well.

ColdFire V1 Full Chip Simulation Connection

You can retrieve the following types of information from the Trace window:

- Instructions and instruction addresses,
- Data address, data value and read/write access type,
- True time, cycles and total simulation cycles for each instruction,
- Function name and module name for each instruction,
- Variable name and module name for each global variable data access.

Figure 28.10 Bus Trace Data Access Symbolic Information

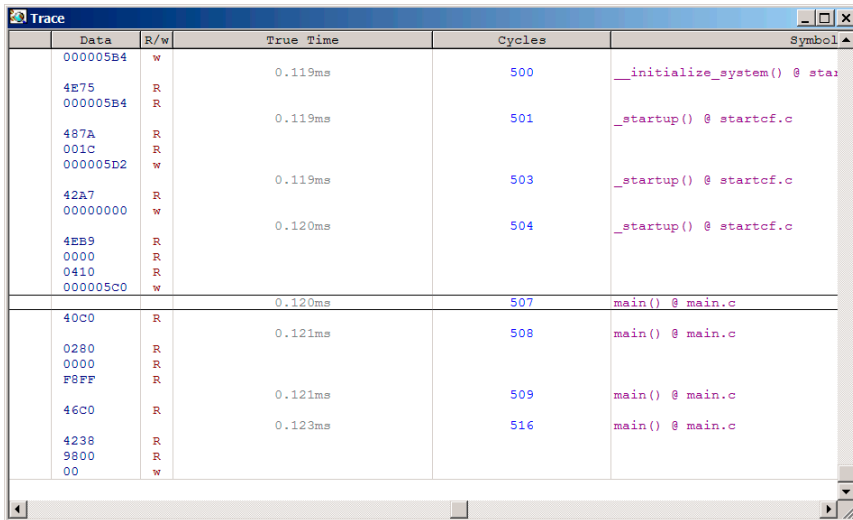

Data	R/w	True Time	Cycles	Symbol
000005B4	w	0.119ms	500	_initialize_system() @ star
4E75 000005B4	R R	0.119ms	501	_startup() @ startof.c
487A 001C 000005D2	R R w	0.119ms	503	_startup() @ startof.c
42A7 00000000	R w	0.120ms	504	_startup() @ startof.c
4EB9 0000 0410 000005C0	R R R w	0.120ms	507	main() @ main.c
40C0	R	0.121ms	508	main() @ main.c
0280 0000 F8FF	R R R	0.121ms	509	main() @ main.c
46C0	R	0.123ms	516	main() @ main.c
4238 9800 00	R R w			

Full Chip Simulation Warnings

By default, the FCS generates warning messages when the application accesses on-chip registers that are not implemented for the selected derivative. These warnings appear in the Command window.

For example, the following messages can be indefinitely repeated in the Command window:

```

...
...
...
FCS Warning (ID 12): reading from unimplemented register at pc =
0x400a'L. Value: 0x0, Memory Address: 0x106. Flash CONTROL module not
implemented

```

```

FCS Warning (ID 12): reading from unimplemented register at pc =
0x400a'L. Value: 0x0, Memory Address: 0x106. Flash CONTROL module not
implemented
FCS Warning (ID 12): reading from unimplemented register at pc =
0x400a'L. Value: 0x0, Memory Address: 0x106. Flash CONTROL module not
implemented
FCS Warning (ID 12): reading from unimplemented register at pc =
0x400a'L. Value: 0x0, Memory Address: 0x106. Flash CONTROL module not
implemented
STOPPING
HALTED

```

Warning message IDs usually belong to a group of registers from the same simulated block (the messages above are from the Flash CONTROL registers block). Therefore, any access to an unimplemented Flash CONTROL register generates the same kind of message.

The debugger provides a set of commands to hide specific ID messages, to stop the FCS automatically, or to display a warning message box. You can execute these commands from a POSTLOAD command file. These commands are volatile and not saved in current project.

WARNING_SETUP Command

The `WARNING_SETUP` command sets the level of debugger warning to inform the user about the usage of a not simulated register.

Components

Debugger engine.

Usage

```
WARNING_SETUP <HALT | CLMSG | MSGBOX | NONE | STATUS>
```

WARNING_SETUP STATUS: displays the current warning setup status.

Example:

```
in>warning_setup status
```

```
WARNING_SETUP STATUS: CLMSG
```

WARNING_SETUP HALT: The FCS stops the debugger when a warning message occurs.

ColdFire V1 Full Chip Simulation Connection

Example:

```
in>warning_setup none
in>warning_setup halt
in>warning_setup status
WARNING_SETUP STATUS: HALT
```

WARNING_SETUP CLMSG: Warning messages appear in the Command window (debugger default).

Example:

```
in>warning_setup none
in>warning_setup clmsg
in>warning_setup status
WARNING_SETUP STATUS: CLMSG
```

WARNING_SETUP MSGBOX: A message box appears on warning. Pressing Cancel stops the FCS. Pressing OK resumes the FCS.

Figure 28.11 FCS Warning Message Box

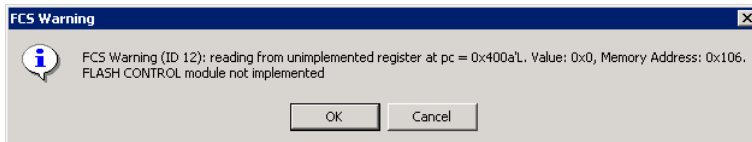

Example:

```
in>warning_setup none
in>warning_setup msgbox
in>warning_setup status
WARNING_SETUP STATUS: MSGBOX
WARNING_SETUP NONE: clears all kinds of warning messages.
in>warning_setup none
in>warning_setup status
WARNING_SETUP STATUS: No warning messages
```

NOTE With HALT, CLMSG and MSGBOX options, executing the command several times toggles the setup on and off.

MESSAGE_HIDE_ID Command

The MESSAGE_HIDE_ID command hides a message of a specific ID.

Components

Debugger engine.

Usage

```
MESSAGE_HIDE_ID <message number (ID)>
```

Example:

```
in>MESSAGE_HIDE_ID 1
in>warning_setup status
WARNING_SETUP STATUS: CLMSG
Hidden message ID: 1
```

MESSAGE_SHOW_ID Command

The MESSAGE_SHOW_ID shows back the hidden message of a specific ID.

Components

Debugger engine.

Usage

```
MESSAGE_SHOW_ID <message number (ID)>
```

Example:

```
in>MESSAGE_SHOW_ID 1
```

MESSAGE_HIDE_RESET Command

The MESSAGE_HIDE_RESET commands resets all hidden messages to display them again.

ColdFire V1 Full Chip Simulation Connection

FCS and Silicon On-Chip Peripherals Simulation

Components

Debugger engine.

Usage

MESSAGE_HIDE_RESET

Example:

```
in>MESSAGE_HIDE_RESET
```

Displays all previously hidden messages again.

FCS and Silicon On-Chip Peripherals Simulation

Full Chip Simulation not only simulates the core instruction set but also the on-chip I/O devices. For each implemented derivative or derivative family there is an FCS implementation note in the `Help\pdf` folder of the CodeWarrior installation named `FCS_Notes_<derivative name>.pdf`. These documents contain details on the implementation of each peripheral module within the derivative.

Generating a new project with the **New Project Wizard** and the connection **Full Chip Simulation** sets everything up to run the project with FCS support.

Use **Simulator > Set Derivative** to change the derivative to simulate. In addition to the derivatives there are the special entries ColdFire V1 CORE and ColdFire V1 SAMPLE. The CORE entries allow you to simulate the chip without FCS support (plain instructions only) and the SAMPLE entries allow you to simulate a chip with a minimal set of commonly-available on-chip peripherals.

Figure 28.12 'Set Derivative Dialog Box

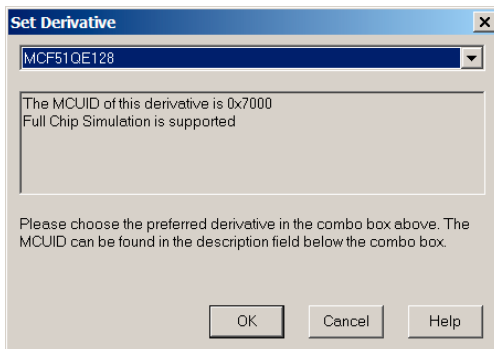

You can see the current mode of Simulation (SAMPLE, CORE or MCU derivative) in the status bar. You can access the **Set Derivative** dialog box by double clicking on the FCS support entry in the status bar. See [Debugger Status Bar with Full Chip Simulation](#).

FCS Visualization Utilities

The debugger component family includes utility components that extend to the production phase of applications, such as the host application builder components and process visualization components.

These components contain visualization utilities that graphically display such things as values, registers, and memory cells, or provide an advanced graphical user interface to the simulated I/O devices, and program variables.

This section describes the components of the visualization utilities that belong to the standard Debugger installation.

WARNING! The following visualization components can only be used with the Full Chip Simulation connection.

Analog Meter Component

Use the Analog Meter window component, shown in [Figure 28.13](#), as a basis for user-provided debugger extension components. It displays several input and output controls that can be manipulated with the mouse.

NOTE For legacy reasons, the Analog Meter component is called **Template**.

Figure 28.13 Analog Meter Template Window

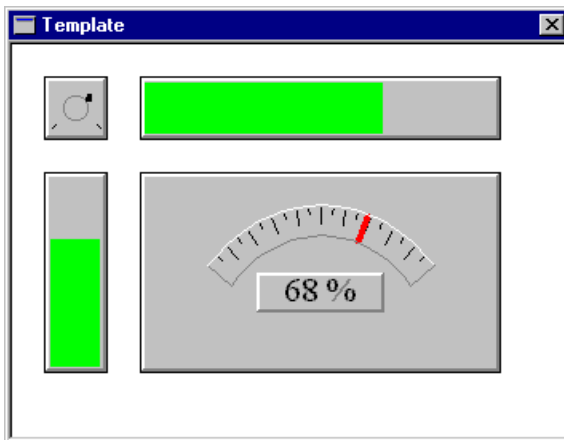

The Analog Meter contains four controls: an analog gauge in the middle, a vertical level bar to the left, a horizontal level bar on top, and a turning ‘knob’ in the top left corner. Click in any of these controls to adjust the value of the meter. The Analog Meter is assigned to address 0x210.

Analog Meter Operations

In the vertical bar, the value can be tracked vertically. In the gauge and horizontal bar, the value can be tracked horizontally. In the knob, the value is adjusted when tracking the mouse around the center.

Analog Meter Menu

The Analog Meter does not have a menu.

IO_LED Component

The IO_LED window shown in [Figure 28.14](#) contains eight LEDs used to manipulate and display the values of memory at an address specified in the related dialog box. LED colors are set at the PORT address (red or green) and the LED states are switched on or off at the DDR address (symbolic values).

Figure 28.14 IO_LED Component Window

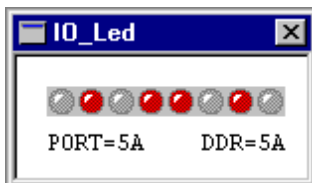

When you change the state of LEDs in this window, the value of the corresponding bit at the DDR address changes in the Memory component window.

IO_LED Operations

Clicking and changing the state of one LED changes the value of the byte at the DDR address.

To change the color of the LEDs, you must change the value of the byte at the PORT address in the Memory Component window.

Specify the location with a string in the form **object.value**. Possible objects and their values can be listed in the Inspector component.

IO_LED Menu

The IO LED Menu contains a single item, **Setup**, that opens the IO_LED Setup dialog box shown in [Figure 28.15](#). Use this dialog box to specify the PORT and DDR addresses.

Figure 28.15 LED Setup Dialog Box

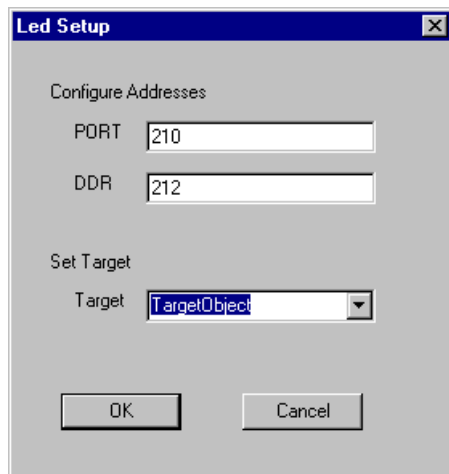

Associated Context Menu

Identical to menu.

Drag Out:

Nothing can be dragged out.

Drop Into:

Nothing can be dropped in.

Demo Version Limitations

No limitations.

LED Component

The LED window shown in [Figure 28.16](#) is a visual utility that displays an arbitrary 8-bit value using an LED bar.

Figure 28.16 LED Window

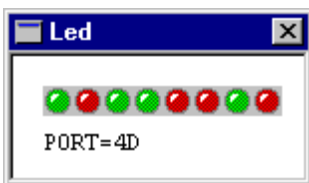

The LED component displays the value in a bit-wise manner with the most significant bit to the left and the least significant bit to the right. Bits with value 0 are shown using a green LED, and bits with value 1 use a red LED. Click an LED to toggle its state. The underlying value changes accordingly.

LED Operations

If you click an LED, its state toggles between green (0) and red (1). The corresponding bit in the underlying value changes as well.

When you right-click within the component window, a context menu appears with the same menu entries as listed in the LED menu in the main menu bar.

LED Menu

The LED menu contains a single item, **Setup**, that opens the dialog box shown in [Figure 28.17](#).

Figure 28.17 LED Setup Dialog Box

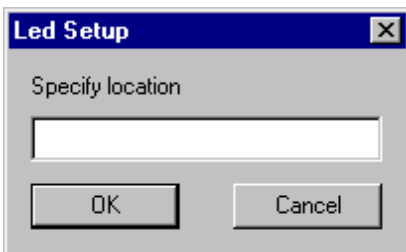

In the text field, the user can specify which value the LED bar displays. Specify the location with a string in the form **object.value**. Possible objects and their values can be listed in the Inspector component.

ColdFire V1 Full Chip Simulation Connection

FCS Visualization Utilities

Click **OK** to accept the specified location. Click **Cancel** to discard changes and retain the previous location.

Example:

If the specified location is `TargetObject.#210`, the LED bar displays the memory byte at address `0x210`.

Drag Out:

Nothing can be dragged out.

Drop Into:

Nothing can be dropped in.

Demo Version Limitations

No limitations.

Phone Component

The Phone window shown in [Figure 28.18](#) is an input utility that provides a graphical keyboard pad that allows you to interactively modify the value of a memory cell.

Figure 28.18 Phone Window



The phone component displays the front panel of a cellular phone with a numeric keypad and LCD display. Click the keys on the keypad to store the corresponding value into the configured memory location. If the mouse is on top of an active key, the arrow shape of the cursor changes to a pointing hand. Currently, the LCD component is not operational.

Phone Operations

Click a phone key and the matching ASCII character of the label on the key is stored at the configured memory cell.

Right-click within the component to display a context menu with the same menu entries as the Phone menu in the main debugger menu.

Phone Menu

The Phone menu contains the **Address** command, which opens the Phone Address dialog shown in [Figure 28.19](#). In the text field of this dialog box, the user can specify the address of the memory cell where keypad characters will be stored. Specify the location with a hexadecimal number.

Figure 28.19 Phone Address Dialog Box

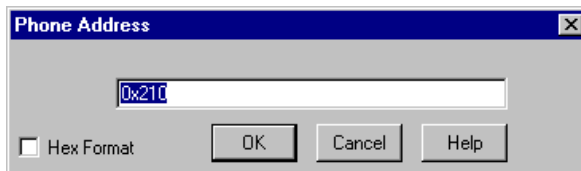

Click **OK** to accept the specified address. Click **Cancel** to discard changes and retain the previous address.

Example:

Specifying the address **210** associates the Phone component keypad with the memory byte at address 0x210.

Drag Out:

Nothing can be dragged out.

Drop Into:

Nothing can be dropped in.

Demo Version Limitations

No limitations.

ADC/DAC Component

The ADC_DAC window shown in [Figure 28.20](#) consists of an Analog to Digital (ADC) and a Digital to Analog (DAC) converter.

Figure 28.20 ADC/DAC Window

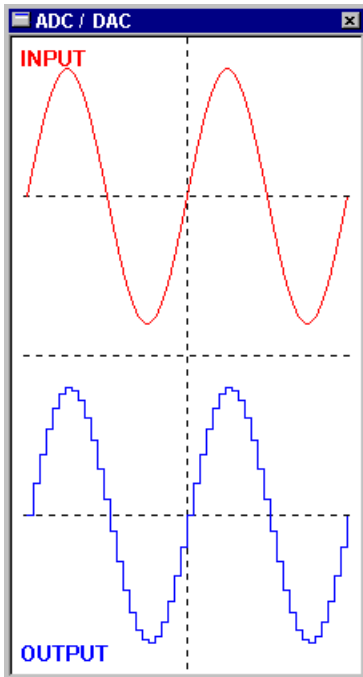

Description

The ADC/DAC component consists of four units as shown in [Figure 28.21](#):

- A signal generator
- An analog to digital converter (ADC)
- A digital to analog converter (DAC)
- A visualization unit

Figure 28.21 Internal Converter Module Organization and Coupler Connections

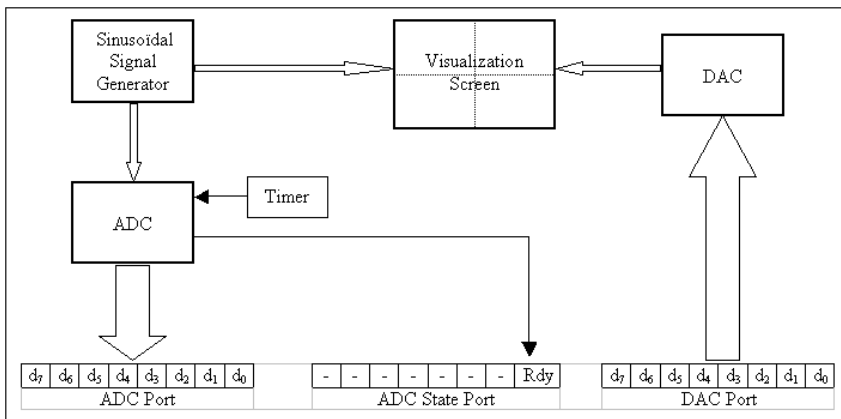

The fourth unit shows the value of the initial analog signal and value of the DAC output analog signal.

This component communicates with the mainframe through three parallel ports of eight bits:

- A port with 1 significant bit to indicate the conversion state.
- An input port to recover the ADC values
- An output port to send values to the DAC in order to visualize them

Signal Generator

The signal generator only generates a sinus signal. The generator output connects to the ADC visualization screen.

Visualization Screen

The visualization screen is a 200-point horizontal resolution screen. The sinus signal period deploys in red by default, shown in the upper part of the screen in [Figure 28.20](#), and the signal generated by the DAC appears in blue in the lower part.

ADC

The ADC is an 8-bit resolution converter generating unsigned values. [Figure 28.21](#) shows that its entry is directly connected to the signal generator. The conversion order is given by a timer that is not connected to the data bus, therefore it cannot be set by software.

At the end of a conversion, the ADC sets the state bit. This bit automatically resets after read.

ColdFire V1 Full Chip Simulation Connection

FCS Visualization Utilities

DAC

The DAC is an 8-bit resolution converter whose output connects to the visualization screen.

It is only necessary to send a byte into its data port to have its conversion displayed on the visualization screen. This screen only has a 200-point resolution. Sending more than 200 bytes to the converter has no effect.

ADC/DAC Menu

The ADC/DAC menu shown in [Figure 28.22](#) contains all functions associated with the ADC-DAC component. [Table 28.4](#) describes these entries.

Figure 28.22 ADC/DAC Menu

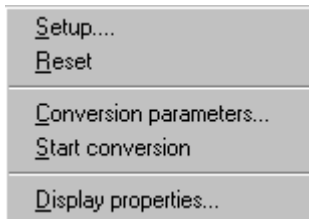

Table 28.4 ADC/DAC Menu Description

Menu Entry	Description
Setup	Opens the ADC/DAC Setup dialog box, allowing you to set the port addresses.
Reset	Erases the visualization screen and re-initializes the display properties.
Conversion Parameters	Opens the Conversion Parameters dialog box, allowing you to set the signal frequency
Start Conversion	Runs the conversion process
Display Properties	Opens the Display Properties dialog box allowing you to set the display properties

ADC/DAC Setup Dialog Box

The dialog box shown in [Figure 28.23](#) allows you to define the port and address or select one port of the five proposed. These ports are used when this component functions with the [Programmable IO Ports Component](#).

Figure 28.23 ADC/DAC - Setup Dialog Box

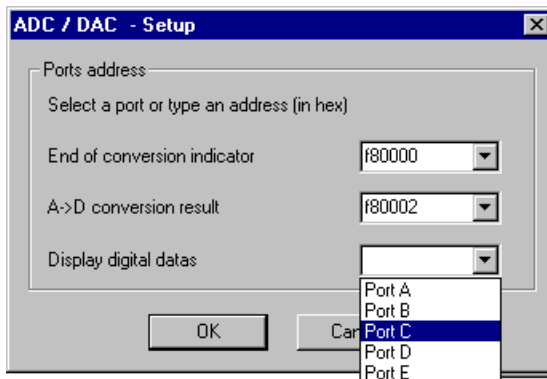

Conversion Parameters Dialog Box

The dialog box shown in [Figure 28.24](#) allows you to choose the analog signal frequency generated by the sinus generator and the sampling frequency. The choice of these two frequencies internally initializes the timer, which gives the conversion orders.

Figure 28.24 Conversion Parameters Dialog Box

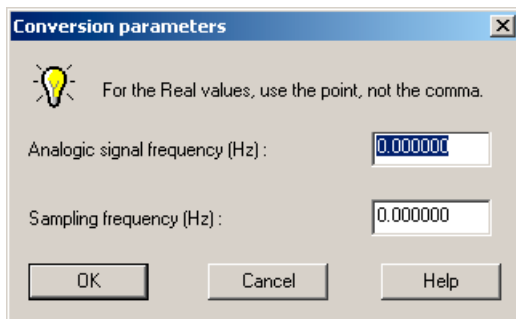

Now you can start the conversion with Start conversion menu entries.

Display Properties Dialog Box

This dialog box, shown in [Figure 28.25](#), allows you to modify the display properties from the ADC/DAC component. The Up and Down buttons allow you to define the vertical position of the input and output curves. Two control buttons allow you to change the axes scales.

Figure 28.25 Display Properties Dialog Box

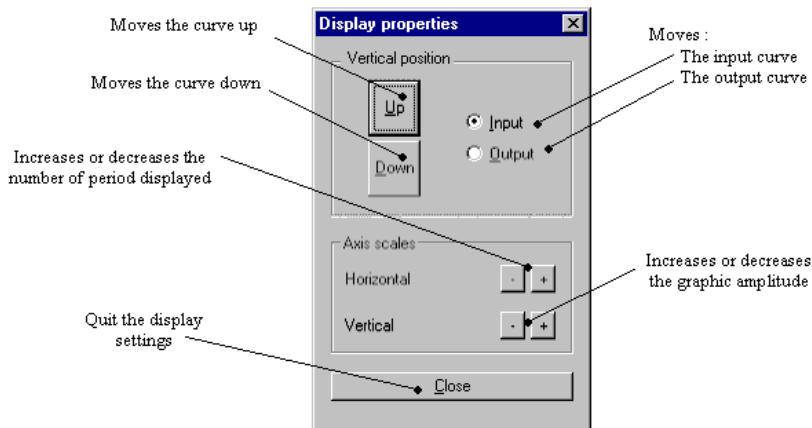

ADC/DAC Operations

To convert a signal from an example application:

1. Load the application and the ADC/DAC component.
2. Choose the ports address
3. Define the input signal frequency
4. Define the sampling frequency
5. Start the application
6. Choose **Start Conversion**

Drag Out:

Nothing can be dragged out.

Drag Into:

Nothing can be dragged in.

IT_Keyboard Component

The 20-key IT_Keyboard shown in [Figure 28.26](#) generates an interruption when a key is pressed.

Figure 28.26 IT_Keyboard Window



These 20 keys are positioned at the intersection of the five lines, X0 to X4, and the four columns, Y0 to Y3. The resistor R connected to the positive supply gives a logical level 1 when there is no connection (key not pressed). The activation of a line (or column) gives a logical level 0, and a key pressed on this line (or column) places the column (or the line) corresponding on the low level. For example, if you activate line X2, column Y3 decreases from logical level 1 to logical level 0 when the « B » key is pressed.

An interruption is raised when an active key (line or column activated) is pressed.

Figure 28.27 IT_Keyboard Constitution

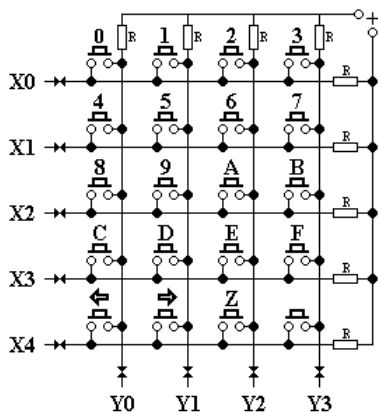

ColdFire V1 Full Chip Simulation Connection

FCS Visualization Utilities

Scanning is one method to read such keyboards. Typically, we can proceed as follows (the line being in output and the column in input):

- Put a 0 at line X4 (X3, X2, X1, X0 being at 1).
- Read the column successively, from Y3 to Y0.
- Put a 0 at line X3 (X4, X2, X1, X0 being at 1).
- Read the column again from Y3 to Y0.
- Continue till the last column of the last line, and restart at the beginning

All keyboard keys are scanned until we find one that is activated. During the scanning process, it is easy to update a counter representing the number of the key pressed. Raising an interruption when a key is pressed allows you to scan only when a key is activated rather than constantly.

IT_Keyboard Menu

[Figure 28.28](#) shows the IT_Keyboard menu. [Table 28.5](#) describes the menu entries.

Figure 28.28 IT_Keyboard menu



Table 28.5 IT_Keyboard Menu Description

Menu Entry	Description
Setup	Opens the Interrupt keyboard setup dialog.

Interruption Keyboard Setup

The Interruption Keyboard Setup dialog box shown in [Figure 28.29](#) allows you to set the address of the lines port, the columns port, and the number of the interruption vector.

Figure 28.29 Interruption Keyboard - Setup Dialog Box

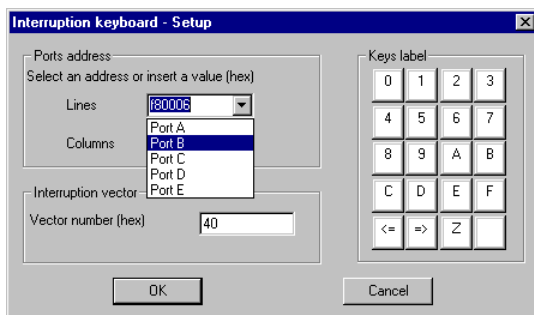

In the **Port address** section, for each two ports you can insert an address (in hexadecimal) in the **Lines** field or select one of the five ports listed in the **Columns** field. These are used when the component works with the [Programmable IO Ports Component](#).

The **Vector number field** allows you to specify an interruption vector number (in hexadecimal).

The **Keys label** buttons permit you to change the symbols displayed on the keyboard keys.

Drag Out:

Nothing can be dragged out.

Drop Into:

Nothing can be dropped into the IT_Keyboard Component window.

Demo Version Limitations

No limitations.

LCD Component

The LCD Display component message box shown in [Figure 28.30](#) is the LCD utility, which can display one or two lines of 16 characters and show or hide the position cursor.

Figure 28.30 LCD Display Message Box

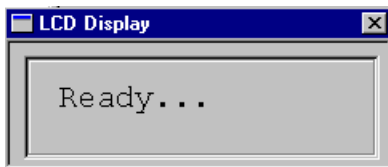

The display module consists of two 8-bit-wide parallel couplers: a data port and a control port, as shown in [Figure 28.31](#). These ports communicate with the mainframe.

Figure 28.31 The LCD Display Module Ports

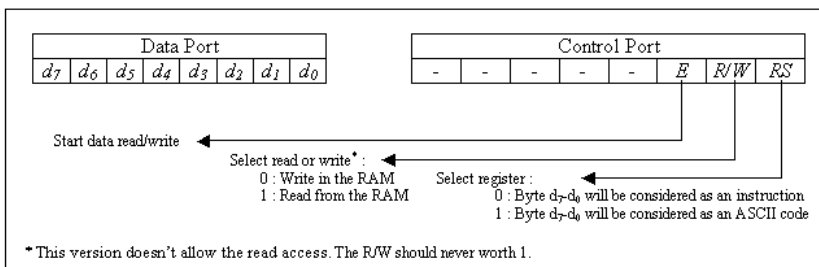

The bits d_7-d_0 represent an ASCII code to display characters or an instruction code. The RS bit defines the status of bits d_7-d_0 .

LCD Operation

The LCD Display device can display one or two lines of 16 characters and show or hide the position cursor.

To manage the display, this device contains a controller: the DDRAM (Display Data RAM). The DDRAM stores the ASCII codes of characters written during a write operation. Only two lines of 16 characters each can be displayed but up to 64 characters can be stored.

This RAM can be seen as organized in two lines: the first one starts at address 00h and ends at 1Fh, and the second one starts at 40h and ends at 5Fh. [Figure 28.32](#) illustrates this arrangement.

Figure 28.32 The DDRAM Controller

	Position on the display																	
	1	2	3	4	5	6	7	8	31	32							
	Addresses (hex)		00	01	02	03	04	05	06	07	1E	1F					
			40	41	42	43	44	45	46	47	5E	5F					
After a left shift	Addresses (hex)		01	02	03	04	05	06	07	08	1F	00					
			41	42	43	44	45	46	47	48	5F	40					
After a right shift	Addresses (hex)		1F	00	01	02	03	04	05	06	1D	1E					
			5F	40	41	42	43	44	45	46	5D	5E					

The Address Counter (AC) is an internal register of the display controller which points at the current address. In the default configuration AC is initialized at 00h and increases when an ASCII character is stored at the address to which AC points. When AC is equal to 1Fh, the next increased value is not 20h, but 40h.

For example, if we send a 48-character string after initialization, the AC stores the bytes at addresses 00h to 1Fh and 40h to 4Fh.

NOTE Only characters having their ASCII codes in the visible interval of the 16 characters (positions 1 to 16) of RAM appear.

Sending Information to the Display

Two steps are necessary to display a character:

1. Set the E and RS bits at 1 and the R/W bit at 0 (control word 00000100b)
2. Write the character ASCII code on the data port. Set bit E to 0 (this validates bits d7-d0).

For an instruction, only step 2 is different: the Byte to write on the data port is the instruction code you want the display controller to execute.

Instruction Listing

[Figure 28.33](#) lists the instructions available for the LCD component.

Figure 28.33 LCD Display Component Instruction Listing

Instruction	Code								Description
	d ₇	d ₆	D ₅	d ₄	d ₃	d ₂	d ₁	d ₀	
Clear Display	0	0	0	0	0	0	0	1	Erases the display and put AC at 0.
Return Home	0	0	0	0	0	0	1	-	Puts the address 00h into AC and re-init the display.
Entry Mode Set	0	0	0	0	0	1	I/D	-	Fixes the moving direction of the cursor
Display On/Off Control	0	0	0	0	1	D	C	-	Lights on or off the display and shows or not the cursor.
Cursor or Display Shift	0	0	0	1	S/C	R/L	-	-	Moves the cursor and shifts the display.
Set DDRAM Address	1	a ₆	A ₅	a ₄	a ₃	a ₂	a ₁	a ₀	Fixes the AC value.
Function Set	0	0	1	DL*	N	-	-	-	Fixes the data exchange width and the line number to display.

Clear Display

- Completely fills the DDRAM with the code 20h (space character)
- Puts the address 00h into AC (address counter)
- Re-initializes the display if shifts occurred.
- Puts the cursor in position 1 on the display first line.

Return Home

- Sets AC = 00h and re-initializes the display.
- Puts the cursor in position 1 on the display first line.
- Leaves the DDRAM unchanged.

Entry Mode Set

- Increases AC if I/D = 1, or decreases AC if I/D = 0, after you write an ASCII code into RAM
- Moves the cursor to the right if ID = 1 or to the left if I/D = 0

Display On/Off Control

- The display is on if D = 1 and off if D = 0 (data stays in RAM)
- If C = 1 the cursor is visible.

Cursor or Display Shift

- Doesn't change the DDRAM content.
- Leaves AC in case of a screen shift.
- Moves and/or shifts the cursor to the right or left. The cursor goes to the second line if it exceeds the 32nd position of the first line. It also goes to the first line when it exceeds the 32nd position of the second line.
- During a screen shift the two lines only move horizontally, the first line never passes to the second one.

[Figure 28.34](#) describes how to choose the moving direction.

Figure 28.34 Left Right Choice

S/C	R/L	
0	0	Moves the cursor to the left (decreases AC).
0	1	Moves the cursor to the right (increases AC).
1	0	Moves the full screen to the left. The cursor follows this move.
1	1	Moves the full screen to the right. The cursor follows this move.

Set DDRAM Address

- Puts the address indicated by a6a5a4a3a2a1a0 into AC.
- When the number of lines is 2, the address goes from 00h to 1Fh for the first line, and from 40h to 5Fh for the second line.
- The a6 bit indicates the line: a6=0 indicates the first line and a6=1 indicates the second line.

Function Set

- If DL = 1, the data exchange is 8 bits wide.
- If N = 0, the display takes place on one line. If N = 1, the display takes place on two lines.

The Initialization Step

Initialization requires seven steps. The Function Set instruction must be sent three times successively to fix the exchange data width, and a fourth time to fix the number of lines used.

The example shown in [Figure 28.35](#) configures the display module in 8-bit mode, two lines, with the cursor visible and an increase of AC (the cursor moves to the right).

Figure 28.35 The LCD Display Initialization

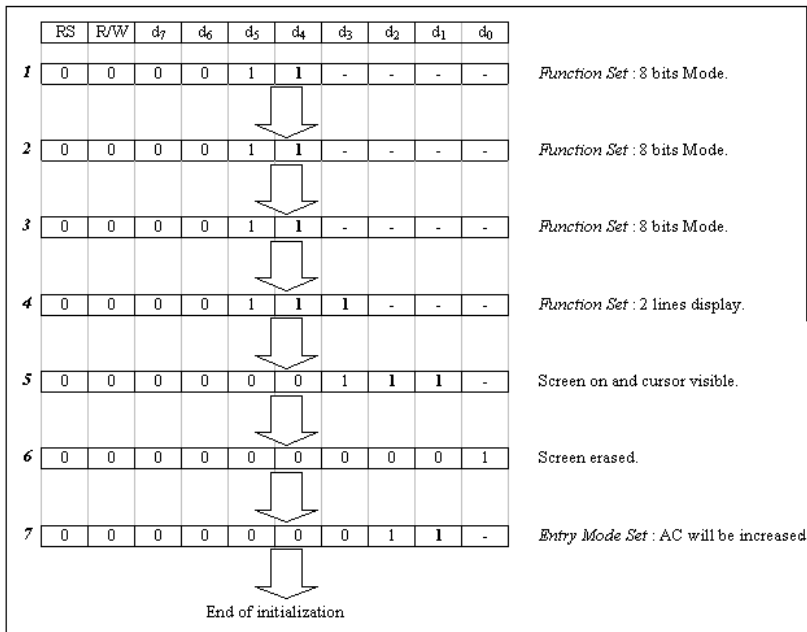

LCD Menu

[Figure 28.36](#) shows the LCD menu, which is identical to the context menu. [Table 28.6](#) describes the entry.

Figure 28.36 LCD Menu

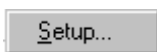

Table 28.6 LCD Display Menu Description

Menu Entry	Description
Setup	Opens the LCD Display dialog box (Setup)

LCD Display

The LCD Display dialog box shown in [Figure 28.37](#) allows you to set the address of the lines port and columns port.

Figure 28.37 LCD Display Dialog Box (Setup)

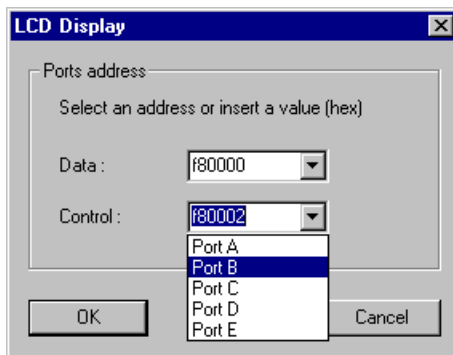

In the **Ports address** section, for each two ports, you can insert an address (in hexadecimal) in the **Lines** field or select one of the five ports listed in the **Columns** field. These are used when the component works with [Programmable IO Ports Component](#).

Drag Out:

Nothing can be dragged out.

Drop Into:

Nothing can be dropped into the LCD display Component.

Demo Version Limitations

No limitations.

Monitor Component

The Monitor window shown in [Figure 28.38](#) is a basic oscilloscope that displays the result of debugger objects.

Figure 28.38 Monitor Window

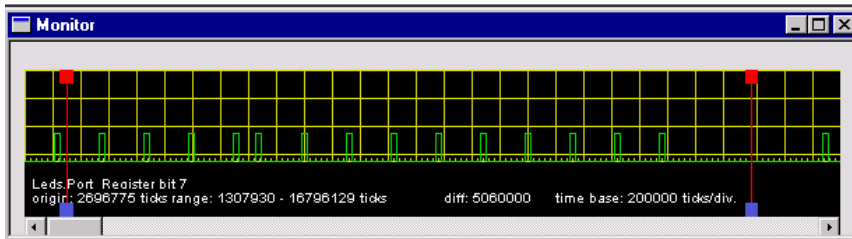

The purpose of this component is to display the results of debugger objects observation in a graphical format (similar to an oscilloscope). The monitor component can save the list of state modifications and associated time in a file.

Monitor Menu

[Figure 28.39](#) shows the Monitor menu and [Table 28.7](#) describes its entries.

Figure 28.39 Monitor Menu

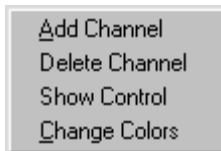

Table 28.7 Monitor Menu Description

Menu Entry	Description
Add Channel	Opens the dialog box to create a new Channel in the Monitor.
Delete Channel	Deletes the Selected Monitor Channel (click on it in the monitor view)
Show Control	Opens the Settings dialog box to change the time base.
Change Colors	Changes colors from the selected Channel.

Add Channel

The Add Channel dialog box shown in [Figure 28.40](#) allows you to create a new Channel in the monitor.

Figure 28.40 Add Channel Dialog Box

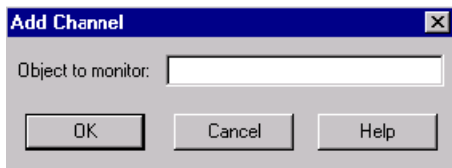

In the text area **Object to monitor**, enter the object name and bit (e.g., TIM12 . PORTT bit 0) and click **OK** to validate or **Cancel** to exit.

Monitor Settings

The Monitor Settings dialog box shown in [Figure 28.41](#) allows you to change the time base.

Select the object name in the list, enter a CPU timer proportional value in the **Ticks** field and a number of pixels in the **Pixels** field to define the horizontal scale. Click **OK** to validate or **Cancel** to exit.

Figure 28.41 Settings Dialog Box

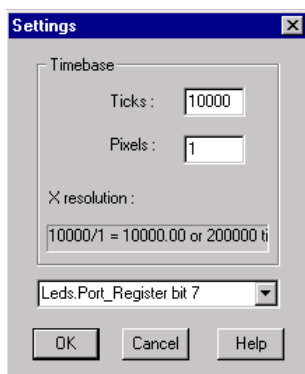

Change Colors

The Change Colors dialog box shown in [Figure 28.42](#) allows you to change the colors from the selected Channel.

Figure 28.42 Change Colors Dialog Box



Select the intended element in the **categories** field and click **Change** to open the standard color selection dialog. Click **OK** to validate or **Cancel** to exit.

Drag Out:

Nothing can be dragged out.

Drop Into:

Nothing can be dropped in.

Demo Version Limitations

No limitations.

Push Buttons Component

The Push Buttons window shown in [Figure 28.43](#) is a basic input device.

Figure 28.43 Push Buttons Window



Push Buttons Menu

[Figure 28.44](#) shows the Push Buttons menu and [Table 28.8](#) describes its entry.

Figure 28.44 Push Buttons Menu

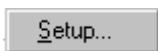

Table 28.8 Push Buttons Menu Description

Menu Entry	Description
Setup	Opens the Push Buttons Setup dialog box.

Push Buttons Setup

The Setup dialog box shown in [Figure 28.45](#) allows you to specify the port address (in hexadecimal format) or select the port in the list.

Figure 28.45 Setup Dialog Box

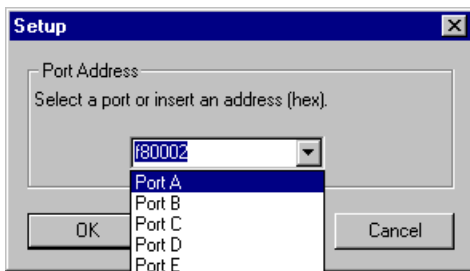

NOTE The port is an output port for the LEDs component.

Use with IO_Ports

The component uses the address defined in the Push Buttons Setup dialog box when working with the [Programmable IO_Ports Component](#).

Use with LEDs Component

[Figure 28.46](#) shows the bytes that the Push Button component sends to the LEDs component.

Figure 28.46 Push Buttons Input Port

Push Buttons Input Port							
b7	b6	b5	b4	b3	b2	b1	b0
<i>PB7</i>	<i>PB6</i>	<i>PB5</i>	<i>PB4</i>	<i>PB3</i>	<i>PB2</i>	<i>PB1</i>	<i>PB0</i>

Sending a value of 1 for a bit lights on the corresponding LED on the LEDs device. For example, if you press button 3, a read access at the address of the component port returns the value 00001000b (08h).

Drag Out:

Nothing can be dragged out.

Drop Into:

Nothing can be dropped in.

Demo Version Limitations

No limitations.

Programmable IO_Ports Component

The Programmable IO_Ports window shown in [Figure 28.47](#) consists of five IO_Ports with eight configurable bits in input or output. In the default configuration all couplers are in input. The graphical interface suggests the state of each one.

Figure 28.47 Programmable IO_Ports Window

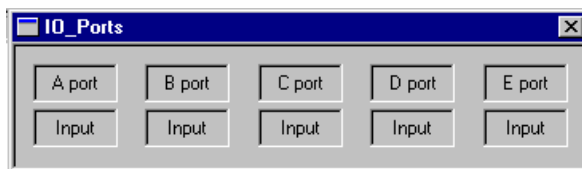

The debugger uses circuits called «input / output couplers » to complete the data exchange between the processor and peripherals. The peripherals are connected to the data bus in parallel. The appropriate output circuit catches information on the data bus and saves it (in a latch) until the next data reception.

The processor perceives the input/output couplers as memory cases with a wired fixed address. The capability exists to do input/output actions at a known address. In C, access is accomplished using forced pointers to these addresses.

A read operation when the coupler is in input mode activates this input during all the read steps. A write operation when the coupler is in output mode activates the output latch during all write steps.

The programmable IO_Ports allows you to define the coupler in input and output. You can modify this configuration during program execution. The first step in the test program is to configure the appropriate couplers.

Programmable IO_Ports Menu

[Figure 28.48](#) shows the Programmable IO_Ports menu and [Table 28.9](#) describes its entry.

Figure 28.48 The Programmable IO_Ports Menu

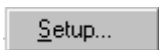

Table 28.9 Programmable IO_Ports Menu Description

Menu entry	Description
Setup	Opens the Programmable IO_Ports Port Address dialog.

Port Address

The Port Address dialog box shown in [Figure 28.49](#) allows you to set the port address and control port address.

Figure 28.49 Port Address Dialog Box (Setup)

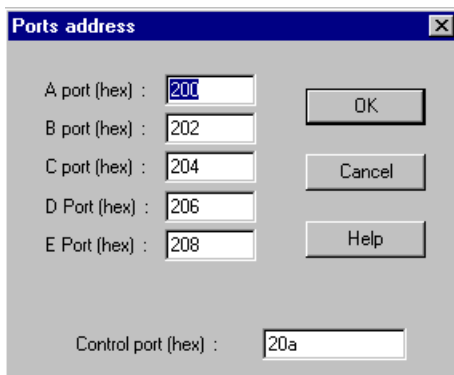

You can enter the address for the five ports **A**, **B**, **C**, **D**, and **E**, and the address for the **Control port**. Click **OK** to validate.

The **Control register** coupler allows you to configure the port type: for each port, set a bit to 1 to configure the port as output and clear to 0 to configure the port as input, as shown in [Figure 28.50](#).

Figure 28.50 Coupler Control Register

Control register								Way		
Bits	b7	b6	b5	b4	b3	b2	b1	b0	Input	0
Ports	-	-	-	E	D	C	B	A	Output	1

Drag Out:

Nothing can be dragged out.

Drop Into:

Nothing can be dropped in.

Demo Version Limitations

No limitations.

7-Segments Display Component

The 7-Segments Display window shown in [Figure 28.51](#) consists of eight 7-segment display systems.

Figure 28.51 7-Segments Display Window

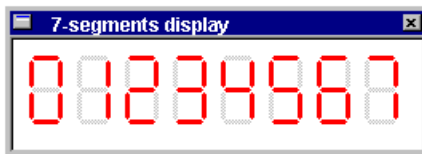

Operation of the 7-segments display component is based on the display scanning principle. Only one display can be activated at a time, for the purpose of limiting consumption of the set.

Common segment connection is the strength of the component. The other connections serve as code input, so the same code applies to all seven, as shown in [Figure 28.52](#).

Scanning consists of selecting a display and activating its segments with adequate code to the input terminals and then attending to the next display.

ColdFire V1 Full Chip Simulation Connection

FCS Visualization Utilities

Figure 28.52 7-Segments Display Component Constitution

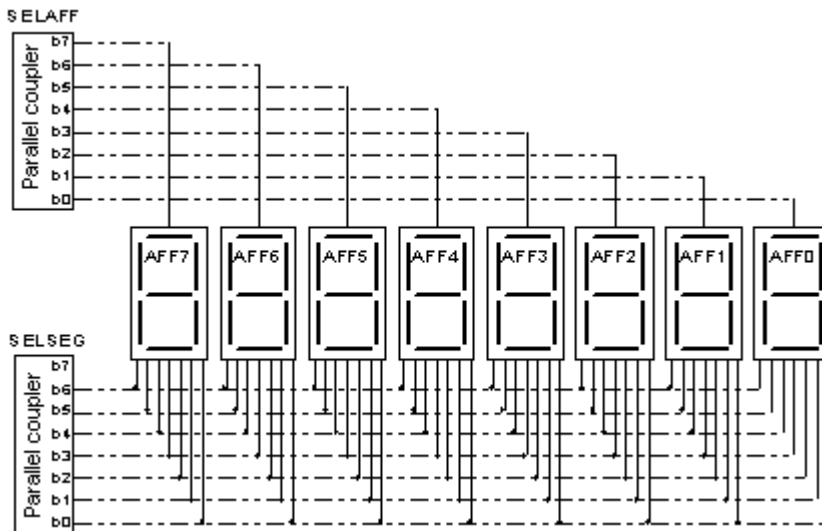

7-Segments Display Menu

[Figure 28.53](#) shows the 7-segments display component menu and [Table 28.10](#) describes its entry.

Figure 28.53 7-Segments Display Menu

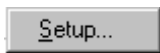

Table 28.10 7-Segments Display Menu Description

Menu Entry	Description
Setup	Opens the Seven segments display component setup dialog.

7-Segments Display Setup

The 7-Segments Display dialog box shown in [Figure 28.54](#) allows you to select the display and related value.

Figure 28.54 7-Segments Display Dialog Box (Setup)

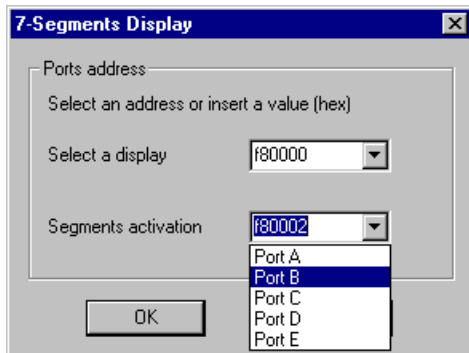

In the **Select a display** section, you can insert an address (in hexadecimal) to select the display. In the **Segment Activation** field, you can set the value of this display. The predefined port is the one used when this component works with the [Programmable IO Ports Component](#).

Control Bits Configuration

The two bytes sent to the 7-segments display must be composed as shown in [Figure 28.55](#).

Figure 28.55 Seven Segments Display Control Bits

SELAFF								SELSEG							
Select of display								Select of segments							
b7	b6	b5	b4	b3	b2	b1	b0	b7	b6	b5	b4	B3	b2	b1	b0
A.ff7	A.ff6	A.ff5	A.ff4	A.ff3	A.ff2	A.ff1	A.ff0	-	g	F	e	d	c	b	a

NOTE The 7-segments display component in FCS is much slower than its real equivalent. In simulation it is not necessary to insert delays between each display scan (for segments light on and observer eye perception).

Drag Out:

Nothing can be dragged out.

Drop Into:

Nothing can be dropped in.

Demo Version Limitations

No limitations.

Stimulation Component

The Debugger also supports **I/O Stimulation**. Using this feature you can generate (stimulate) interrupts or memory access generated by an external I/O device.

NOTE The [True Time I/O Stimulation](#) section describes using this feature in detail, with accompanying examples.

The Stimulation window component shown in [Figure 28.56](#) provides the basic functionality of the Full Chip Simulation. It serves to execute timed action and raise exception events. The Stimulation component displays and executes I/O stimulation described in a text file.

Figure 28.56 Stimulation Window

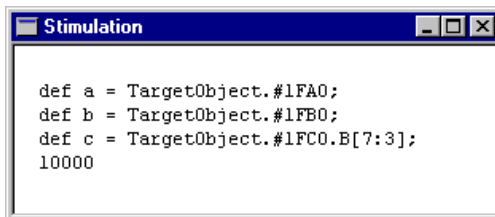

Stimulation Context Menu

[Figure 28.57](#) shows functions associated with the Source component. [Table 28.11](#) describes these functions.

Figure 28.57 Stimulation Context Menu

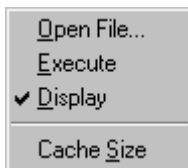

Table 28.11 Stimulation Context Menu Description

Menu Entry	Description
Open File	Opens a dialog box to load a stimulation file.
Execute	Starts execution of the input file.
Display	Switches display of stimulated file on or off.
Cache size	Opens the 'Size of the Cache' dialog box.

Cache Size

The Size of the Cache dialog box, shown in [Figure 28.58](#), allows you to define the number of lines displayed in the Stimulation component. If the **Limited Size of Cache** checkbox is clear, the number of lines is unlimited. If the **Limited Size of Cache** checkbox is checked, the number of lines is limited to the value displayed in the edit box. Specify a value between 10 and 1,000,000. By default, the number of lines is 1000.

Figure 28.58 Size of the Cache Dialog Box

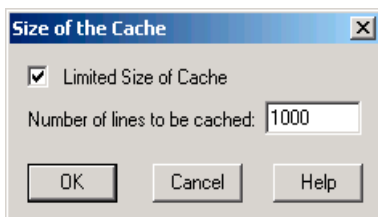

NOTE Increasing the cache size slows new line logging.

Example of a Stimulation File

Using an editor, open the file named `IO_VAR.TXT` located in the project directory. [Listing 28.1](#) is an example file.

Listing 28.1 Stimulation File Example

```
def a = TargetObject.#210.B;

PERIODICAL 200000, 50:
    50000 a = 128;
    150000 a = 4;
```

ColdFire V1 Full Chip Simulation Connection

FCS Visualization Utilities

```
END
10000000 a = 0;
```

The first line defines the stimulated object. This object is located at address 0x210 and is 1 byte wide.

Once 200,000 cycles have executed, debugger accesses the memory location 0x210 periodically 50 times (line 3). First the memory location is set to 128, and then 100000 cycles later, it is set to 4.

NOTE The [True Time I/O Stimulation](#) section describes using this component in detail, with examples.

Drag Out:

Nothing can be dragged out.

Drop Into:

Nothing can be dragged in.

Demo Version Limitations

Only 15 interrupts and memory accesses are generated.

TestTerm Component

The TestTerm window shown in [Figure 28.59](#) is a user-friendly terminal input/output. It provides a simple SCI (Serial Communication Interface) interface, which is independent of Full Chip Simulation.

Figure 28.59 TestTerm Window

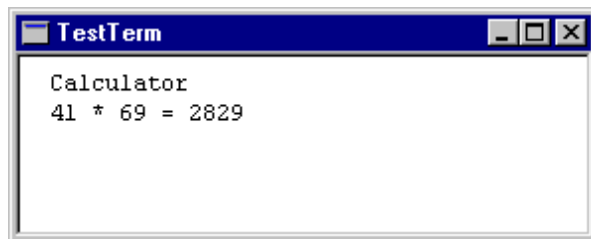

The TestTerm component emulates a serial communication interface based at the address 200 (hexadecimal), thus providing five simulated memory mapped registers described in [Table 28.12](#).

Table 28.12 TestTerm Simulated Memory Mapped Registers

Register Name	Function	Register Address
BAUD	Baud Rate Control	0x0200
SCCR1	Serial Communication Control Register 1	0x0201
SCCR2	Serial Communication Control Register 2	0x0202
SCSR	Serial Communication Status Register	0x0203
SCDR	Serial Communication Data Register	0x0204

[Table 28.13](#) describes the bits used in the Serial Communication Status Register.

Table 28.13 TestTerm Serial Communication Status Register

Bit Name (flag)	Function	Bit Mask Value
TDRE	Transmit Data Register Empty	0x80
RDRF	Receive Data Register Full	0x20

Reading and writing in the BAUD, SCCR1, SCCR2 or SCSR registers has no effect in the TestTerm component, but are required to make the component compatible with specific SCI interfaces.

Simulated I/Os of the TestTerm component do not need initialization. In the terminal interface file `termio.c`, BAUD and SCSR registers are initialized to be compatible with real SCI interfaces.

The SCDR register is valid for reading or writing data. Reading a value from the SCDR register clears the RDRF flag in the SCSR register. Entering a character on the keyboard while TestTerm is active sets the RDRF flag in the SCSR register and puts the ASCII code of the typed key into the SCDR register.

Conceptually, writing a new value in the SCDR register by the target application clears the TDRE flag in SCSR. Transmission completion sets the TDRE flag again. As TestTerm is only an I/O emulation, no delay is simulated and writing into SCDR sets the TDRE flag in the SCSR register.

Output Redirection

Output can be redirected to a TestTerm window, a file, or to both at the same time. File output is monitored by the target system and cannot be specified interactively.

ColdFire V1 Full Chip Simulation Connection

FCS Visualization Utilities

Use Escape sequences to handle redirection of the output data stream. [Table 28.14](#) illustrates the different possible redirections and associated escape sequences where `filename` is a sequence of characters terminated by a control character (e.g., CR) and is a valid filename.

Table 28.14 Redirections and Associated Escape Sequences

Escape Sequence	Function
ESC "h" "1"	Output to Terminal window only.
ESC "h" "2" filename	Output to both Terminal window and file.
ESC "h" "3" filename	Output to file only.
ESC "h" "4"	Read from keyboard
ESC "h" "5" filename	Read input from file <code>fileName</code>
ESC "h" "6" filename	Output to Terminal window and append to file
ESC "h" "7" filename	Append to file only

ESC is the ESC character (ASCII code 27 decimal).

Use these commands anywhere in the output stream.

How to Redirect

By default, an output redirection is set to the TestTerm component window.

The debugger uses the **Term_Direct** function declared in `terminal.h` to redirect an output. [Listing 28.2](#) gives the source code in `terminal.c`.

Listing 28.2 Term_Direct Source Code

```
void Term_Direct(int what, char *fileName)
{
    if (what < 1 && what > FROM_FILE) return;
    Write(ESC); Write('h');
    Write(what + '0');
    if (what != TO_WINDOW && what != FROM_KEYS) {
        PutString(fileName); Write(CR);
    }
}
```

In this case, `what` is one of the following items:

- **TERM_TO_WINDOW** (sends output to terminal window),
- **TERM_TO_BOTH** (send output to file and window),
- **TERM_TO_FILE** (send output to file `fileName`),
- **TERM_FROM_KEYS** (read from keyboard),
- **TERM_FROM_FILE** (read input from file `fileName`),
- **TERM_APPEND_BOTH** (append output to file and window),
- **TERM_APPEND_FILE** (append output to file `fileName`).

See `terminal.h` for more information.

Using TestTerm

[Listing 28.3](#) shows the functions defined in `termport.h` that can be called to access the TestTerm component:

Listing 28.3 Functions to Access the TestTerm Component

```
char GetChar(void);
void PutChar(char ch);
void PutString(char *str);
void InitTermIO(void);
```

[Listing 28.4](#) gives the source code for the functions in `termport.c`.

Listing 28.4 Functions to Access the TestTerm Component in termport.c

```
typedef struct {
    unsigned char BAUD;
    unsigned char SCCR1;
    unsigned char SCCR2;
    unsigned char SCSR;
    unsigned char SCDR;
} SCIStruct;

#define SCI (*((SCIStruct*)(0x0200))
char GetChar(void)
{
    while (!(SCI.SCSR & 0x20)); /* wait for input */
    return SCI.SCDR;
}

void PutChar(char ch)
{
    while (!(SCI.SCSR & 0x80)); /* wait for output buffer
```

ColdFire V1 Full Chip Simulation Connection

FCS Visualization Utilities

```

                                                                    empty */
    SCI.SCDR = ch;
}

void PutString(char *str)
{
    while (*str) {
        PutChar(*str);
        str++;
    }
}

void InitTermIO(void)
{
    SCI.BAUD = 0x30;          /* baud rate 9600 at 8 MHz */
    SCI.SCCR2 = 0x0C;       /* 8 bit, TE and RE set */
}

```

TestTerm Menu

The TestTerm component menu shown in [Figure 28.60](#) lets you set the Cache Size in lines. Selecting this menu entry accesses the dialog box shown in [Figure 28.61](#).

Figure 28.60 TestTerm Menu

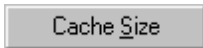
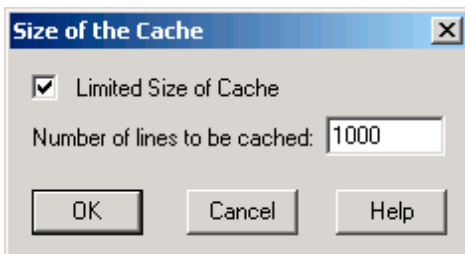

Figure 28.61 TestTerm Cache Size Dialog Box



Drag Out:

Nothing can be dragged out.

Drop Into:

Nothing can be dropped in.

Demo Version Limitations

No limitations.

Terminal Component

Use the Terminal window shown in [Figure 28.62](#) to simulate input and output. It can receive characters from several input devices and send them to other devices.

Figure 28.62 Terminal Window

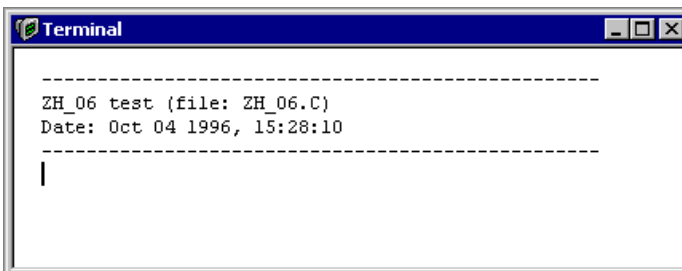

You can use a virtual SCI (Serial Communication Interface) port provided by the framework for communication with the target, but it is also possible to use the keyboard, the display, some files or even the serial port of your computer as I/O devices.

To control and configure a terminal component use the Terminal menu of the terminal shown in [Figure 28.63](#).

Figure 28.63 Terminal Menu and Context Menu

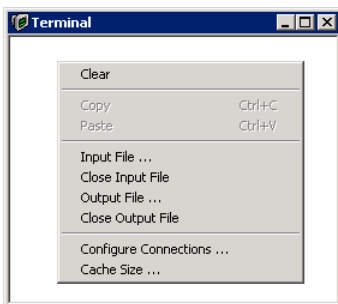

To open the context menu, right click in the terminal window.

Configure Terminal Connections

The terminal window is very flexible and can redirect characters received from any available input device to any available output device. You can specify these connections by choosing **Configure Connections** in the context menu of the terminal component. This opens the dialog box shown in [Figure 28.64](#).

Figure 28.64 Configure Terminal Connections Dialog Box

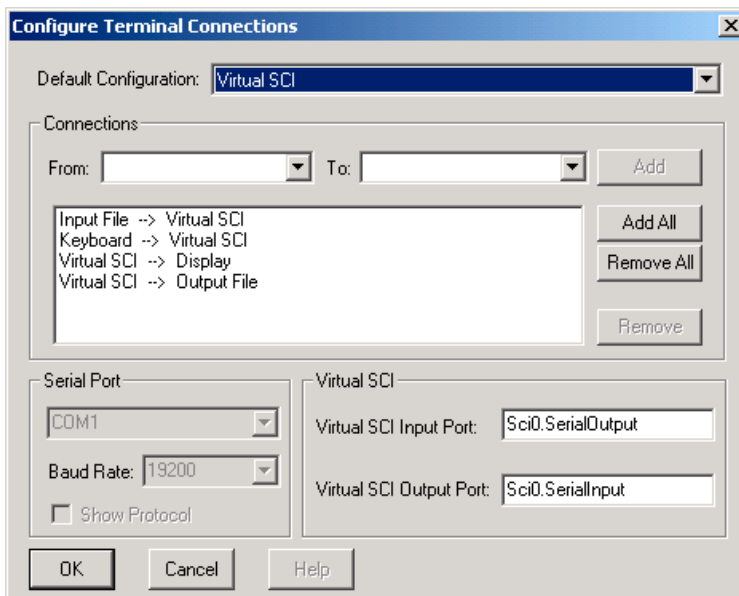

You can choose one of the default configurations in the **Default Configuration** combo box. The **Connections** section lists all active connections in a list box. There you can customize which input devices to redirect to which output devices by adding and removing connections.

To add a connection, specify the source and target devices using the **From** and **To** combo boxes and then press the **Add** button. The new connection appears in the active connection list below.

To remove connections, select them in the list of active connections and press the **Remove** button.

In the **Serial Port** section you can specify which serial port to use and its properties. This is only possible if at least one connection from or to the serial port exists.

If you have chosen a connection from or to the virtual SCI port, you can also specify, in the **Virtual SCI** section, which ports to use as virtual SCI ports. This enables you to make a connection to any port in the FCS framework.

Input and Output File

You can use a file as an input stream for the terminal component or redirect the output to a file.

To use a file as an input stream, make sure that at least one connection exists from the input file to any output device. Then you can open an input file by choosing **Input File** from the context menu. As soon as you press the **OK** button in the **File Open** dialog, input from the file starts. The file closes as soon as the end of file is reached or when you choose **Close Input File** from the context menu.

When the input file reaches its end a CTRL-Z character (ASCII code 26 decimal) is sent to all output devices receiving characters from the input file to notify them that the file transfer is complete.

Redirecting input devices to an output file is a similar process. Choose your connections from input devices to the output file. Then open or create your output file by choosing **Output File** from the context menu. If the file does not exist the debugger creates it. Otherwise you can choose to overwrite or append the existing file. To stop writing to the output file choose **Close Output File** from the context menu.

File Control Commands

You can open and close input and output files through special Escape sequences in the data stream from the serial port or virtual SCI. [Table 28.15](#) illustrates the different possible commands and associated Escape sequences where `filename` is a sequence of characters terminated by a control character (e.g. CR) and is a valid filename.

Table 28.15 Terminal File Control Commands

Escape Sequence	Function
ESC "h" "1"	Close output file.
ESC "h" "2" filename	Open output file.
ESC "h" "3" filename	Open output file and suppress output to terminal display.
ESC "h" "4"	Close input file
ESC "h" "5" filename	Open input file.

ColdFire V1 Full Chip Simulation Connection

FCS Visualization Utilities

Table 28.15 Terminal File Control Commands (continued)

Escape Sequence	Function
ESC "h" "6" filename	Append to existing output file.
ESC "h" "7" filename	Append to existing output file and suppress output to terminal display.

ESC is the ESC Character (ASCII code 27 decimal).

You can give these commands in the data stream sent from the serial port or virtual SCI port, but not from the input file or the keyboard. They have an effect only if there are any connections reading from the input file or writing to the output file.

Use the **TERM_Direct** function declared in `terminal.h` to send such commands from a target via SCI to the terminal. [Listing 28.5](#) gives the source code in `terminal.c`.

Listing 28.5 TERM_Direct Source Code

```
void TERM_Direct(TERM_DirectKind what, const char* fileName) {
    /* sets direction of the terminal */
    if (what < TERM_TO_WINDOW || what > TERM_APPEND_FILE) return;
    TERM_Write(ESC); TERM_Write('h');
    TERM_Write((char)(what + '0'));
    if (what != TERM_TO_WINDOW && what != TERM_FROM_KEYS) {
        TERM_WriteString(fileName); TERM_Write(CR);
    }
}
```

In the example, the parameter `what` is one of the following constants:

- **TERM_TO_WINDOW**: send output to terminal window
- **TERM_TO_BOTH**: send output to file and window
- **TERM_TO_FILE**: send output to file `fileName`
- **TERM_FROM_KEYS**: read from keyboard (close input file)
- **TERM_FROM_FILE**: read input from file `fileName`
- **TERM_APPEND_BOTH**: append output to file and window
- **TERM_APPEND_FILE**: append output to file `fileName`

See also `terminal.h` for further details.

Using the Virtual SCI

In its default **Virtual SCI** configuration the terminal component accesses the target through the Object Pool interface.

To make the terminal component work in this default configuration, the target must provide an object with the name **Sci0**. If no **Sci0** object is available, no input or output happens. It is possible to check, through the Inspector component, whether the environment currently provides an **Sci0** object.

NOTE Only some specific FCS components currently have an **Sci0** object. For all other FCS components the default virtual SCI port does not work, unless you load a user-defined **Sci0** object with the specified register name.

Write access to the target application is done with the Object Pool function **OP_SetValue** at the address **Sci0.SerialInput**.

A subscription to an Object Pool register with the name **Sci0.SerialOutput** handles input from the target application. When this register changes (sends a notification), a new value is received.

For implementations of this register with help of the **IOBase** class, use the **IOB_NotifyAnyChanges** flag. Otherwise only the first of two identical characters are received.

It is also possible to configure the terminal to use another object in the Object Pool instead of **Sci0** with which to communicate. Refer to [Configure Terminal Connections](#) for information about where you can do this.

Cache Size

The item **Cache Size** in the context menu allows you to set the number of lines in the terminal window, using the dialog shown in [Figure 28.65](#).

Figure 28.65 Size of the Cache Dialog Box

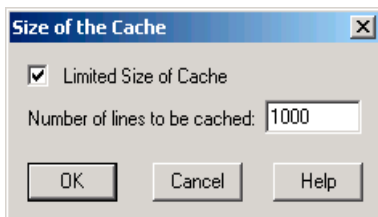

Wagon Component

The Wagon window shown in [Figure 28.66](#) simulates a tool machine wagon functionality.

Figure 28.66 Wagon Window

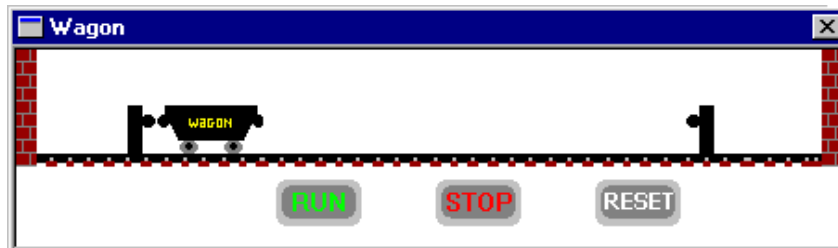

At first, the wagon is at the left border position. When you click the **RUN** button, the wagon goes to the right side. Upon arriving at the right border, the wagon returns to the left side. The **RESET** button positions the wagon at the left border. The **STOP** button stops the wagon at the current position.

Wagon Menu

[Figure 28.67](#) shows the Wagon menu. [Table 28.16](#) describes its entry.

Figure 28.67 Wagon Menu

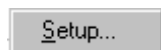

Table 28.16 Wagon Menu Description

Menu Entry	Description
Setup	Opens the Wagon setup dialog box shown in Figure 28.68 .

Wagon Setup

When you select Setup from the Wagon Menu, the Ports Address Selection dialog box appears. This is the Wagon component Setup window.

Figure 28.68 Ports Address Selection Dialog Box

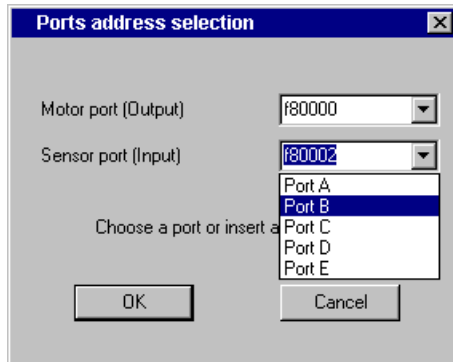

In the **Motor Port** section, you can insert an address (in hexadecimal) to select the Wagon direction. In the **Sensor Port** field you can insert an address (in hexadecimal) to select the Wagon position. Predefined ports are fixed when the component operates with the [Programmable IO Ports Component](#).

Control Bits Configuration

The 2 bytes sent to the wagon component must be composed as shown in [Figure 28.69](#).

Figure 28.69 Wagon Control Bits Description

Motor port								Sensor port							
b7	b6	b5	b4	b3	b2	b1	b0	b7	b6	b5	b4	b3	b2	b1	b0
<i>l</i>	-	-	-	-	-	-	<i>r</i>	<i>bl</i>	-	-	<i>st</i>	<i>stp</i>	-	-	<i>br</i>

To move the wagon to the right, set bit **r**. To move the wagon to the left, set bit **l**. The sensor port sets the **bl** bit when the wagon is at the left border, sets bit **br** when the wagon is at the right border, sets bit **st** when you click the **START** button with the left mouse button, and sets **stp** when you click the **STOP** button.

True Time I/O Stimulation

The FCS I/O Stimulation component is a facility to trigger I/O events. With the Stimulation component loaded, you can simulate interrupts and register modifications invoked by the hardware. This tutorial introduces and explains examples of stimulation files. This section contains the following subsections:

- [Stimulation Program Examples](#)
- [Stimulation Input File Syntax](#)

Stimulation Program Examples

The following examples illustrate common stimulation programs.

Running an Example Program Without Stimulation

1. Run the debugger with the FCS connection.

[Figure 28.70](#) shows the Main Window.

Figure 28.70 FCS I/O-Simulation Main Window

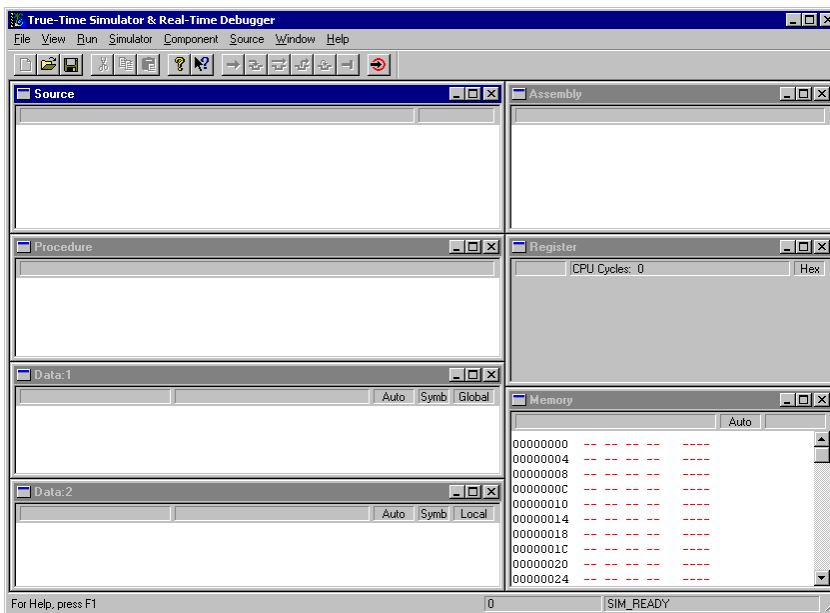

2. Choose **Simulator > Set > Sim.**
3. Choose **Component > Open > Io_led**
[Figure 28.71](#) shows the IO_LED component.

Figure 28.71 IO_LED Component Window

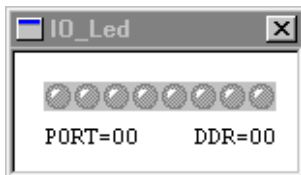

4. Choose **Component > Open > Template.**
[Figure 28.72](#) shows the Template component.

Figure 28.72 Template Component Window

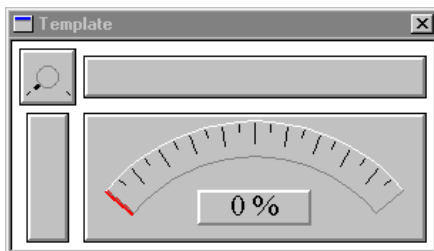

5. Choose **Simulator > Load io_demo.abs.**
6. Choose **Run > Start/Continue** or click the green arrow icon.
7. If the program halts in startup, click the **Start/Continue** command again.
8. Choose **Run > Halt** to stop execution after a few seconds.

The Template component is a view linked to a specific memory location in TargetObject. In the source code of the test program, you can find a variable associated with it:

```
#define PORT_DATA          *((volatile unsigned char *)0x0210)/* Value
with range 0..255 */
```

The Template component polls this value and displays it in a speedometer-like outlook.

The procedure **IO_Show** in `io_demo.c`, shown in [Listing 28.6](#), increments or decrements this value, depending on the raise direction. The raise direction depends on a global variable `dir` that is turned back when the top or bottom value is reached.

ColdFire V1 Full Chip Simulation Connection

True Time I/O Stimulation

Listing 28.6 IO_Show Procedure in io_demo.c

```
static void IO_Show(void) {
    for (;;) {                                // endless loop
        dir = 1;
        do {
            Delay();
            PORT_DATA++;
        } while ((dir == 1) && (PORT_DATA != 255));
        dir = -1;
        do {
            Delay();
            PORT_DATA--;
        } while ((dir == -1) && (PORT_DATA != 0));
    }
}
```

Example Program with Periodic Variable Stimulation

1. Choose **Simulator > Reset**.
2. Choose **Simulator > Load Io_demo.abs**.
3. Choose **Component > Open > Stimulation**

[Figure 28.73](#) shows the Stimulation component.

Figure 28.73 Stimulation Component Window

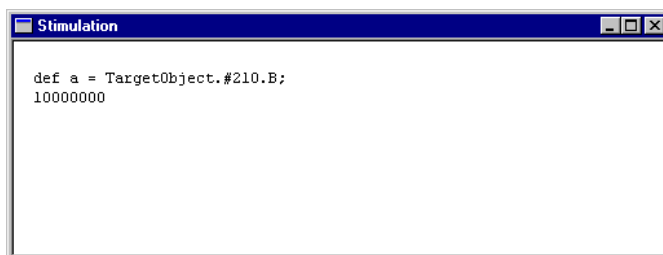

4. Activate the Stimulation Window by clicking on it.
5. Choose **Stimulation > Open File io_var.txt**.
6. Choose **Stimulation > Execute**.
7. Choose **Run > Start/Continue**.

The **Stimulation** component executing `io_var.txt` accesses `TargetObject` at address **0x210** associated with **PORT_DATA** in the source. You can observe this by watching the `Template` component. The arrow is not raising steadily, but jumps around. The `Stimulation` component now handles the value of **PORT_DATA**.

Using an editor, open the file named `io_var.txt` in the FCS demo directory. This file looks like [Listing 28.7](#).

Listing 28.7 `io_var.txt`

```

/* Define an identifier a, which is located at address 0x210*/
/* This identifier is 1 Byte wide.*/
def a = TargetObject.#210.B;

/* After 200 000 cycles have expired, repeat 50 time */
/* the code sequence specified between the keywords */
/* PERIODICAL and END. */
PERIODICAL 200000, 50:
    50000 a = 128; /* After 50 000 cycles, write 128 at address 0x210. */
    150000 a = 4; /* After 150 000 cycles, write 4 at address 0x210. */
END

10000000 a = 0; /* After 10 000 000 cycles, write 0 at address 0x210. */

```

First, the simulated object is defined. This object is located at address `0x210` and is 1 byte wide. Once 200,000 cycles have been executed, the memory location `0x210` is accessed periodically 50 times. First the memory location is set to 128, then 100,000 cycles later, it is set to 4.

Example Program with Stimulated Interrupt

1. Choose **Simulator > Reset**.
2. Activate `Stimulation Window` by clicking on it.
3. Choose **Stimulation > Open File `io_int.txt`**.
4. Select the `Source` component window.
5. Choose **Source > Open Module `io_demo.c`**.
6. Scroll into the procedure `Interrupt_Routine`.
7. Set a breakpoint in the `Interrupt_Routine` as shown below.

[Figure 28.74](#) shows the `Source` component window.

ColdFire V1 Full Chip Simulation Connection

True Time I/O Stimulation

Figure 28.74 Source Component Window

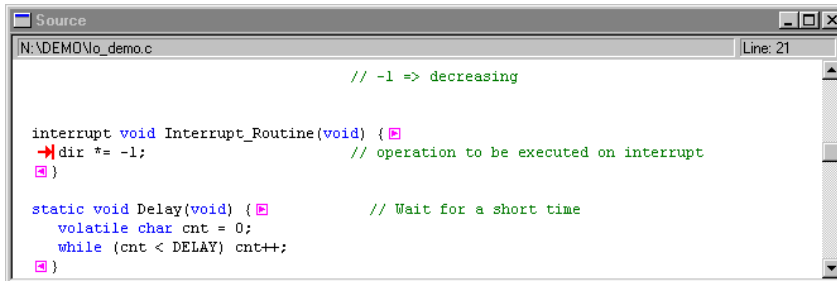

```

Source
N:\DEMO\io_demo.c Line: 21
// -1 => decreasing

interrupt void Interrupt_Routine(void) {
    dir *= -1; // operation to be executed on interrupt
}

static void Delay(void) { // Wait for a short time
    volatile char cnt = 0;
    while (cnt < DELAY) cnt++;
}
    
```

8. Activate the Stimulation Window by clicking on it.
9. Choose **Stimulation > Execute**.
10. Choose **Run > Start/Continue**.

After about 300,000 cycles the FCS stops on the breakpoint in the interrupt routine and highlights the corresponding source line. The interrupt is called. Start the FCS. It stops approximately each 100,000 cycles on the same breakpoint. Restart and repeat these actions until 1,200,000 cycles. Start again. The FCS runs until 10,000,000 cycles and stops on the breakpoint. Start the FCS. It continues to run. The stimulation is finished.

The interrupts have been invoked by the Stimulation component source `io_int.txt`. [Listing 28.8](#) gives the Stimulation file listing.

Listing 28.8 io_int.txt

```

def a = TargetObject.#210.B;

PERIODICAL 200000, 10:
    100000 RAISE 7, 3, "test_interrupt";
END

10000000 RAISE 7, 3, "test_interrupt";
    
```

In the first line, the stimulated object is defined. The interrupt is raised periodically ten times. The **RAISE** command takes the number of the interrupt in the interrupt vector map as the first argument. This number **7** in our example is arbitrarily chosen. To export this example to a different target processor, look at the interrupt vector map in the technical data manual of the matching MCU. Using an editor, open the `io_demo.prm` file in the same demo directory. You can see at the end of this file how to set the interrupt vector (adapt it to your needs).

```
VECTOR 7 Interrupt_Function /* set vector on Interrupt 7 */
```

If the `prm` file does not specify the interrupt vector address, the FCS stops when interruption is generated. The exception mnemonic (matching the interrupt vector number) appears in the FCS status bar.

The second argument specifies the interrupt priority and the third argument is a free chosen name of the interrupt.

The file `io_int.txt` is used to generate 11 interrupts. Ten periodical interrupts are generated every 100,000 CPU cycles from 200,000 + 100,000 = 300,000 to 1,200,000 CPU cycles. A final interrupt is generated when the number of CPU cycles reaches 10,000,000.

Example of a Larger Stimulation File

[Listing 28.9](#) contains this example and is commented below. This example file may not work as expected if the variables defined here do not refer to a port in `TargetObject`. In our example, we only defined the objects `TargetObject.#210` and `#212` over the `Io_led` component. Definitions of `b`, `c` and `pbits` are here for illustration only. Remove these definition lines and the lines that refer to them, if the example presented here is not executable.

Listing 28.9 Example File `io_ex.txt`.

```
def a = TargetObject.#210.B;
def x = TargetObject.#212;
def b = TargetObject.#216.W;
def c = TargetObject.#220.L;
def pbits = Leds.Port_Register.B[7:3];

#10000 pbits = 3;
20000 a = 0;
+20000 b = pbits + 1;

PERIODICAL 100000, 10:
    10000 a = 128;
30000 RAISE 7, 3, "test_interrupt";
END

1000000 RAISE 7, 3, "test_interrupt";
```

ColdFire V1 Full Chip Simulation Connection

True Time I/O Stimulation

Detailed Explanation

```
def a = TargetObject.#210.B;
```

This line of code defines `a` as byte mapped at address **0x210** in `TargetObject`.

```
def x = TargetObject.#212;
```

This line of code defines `x` as byte mapped at address **0x212** in `TargetObject`. Size can be omitted. `.B` for byte is default.

```
def b = TargetObject.#216.W;
```

This line of code defines `b` as word (`.W`) mapped at address **0x216** in `TargetObject`.

```
def c = TargetObject.#220.L;
```

This line of code defines `c` as long (`.L`) mapped at address **0x220** in `TargetObject`.

```
def pbits = Leds.Port_Register.B[7:3];
```

This line of code defines `pbits` as bits 5, 6 and 7 in the byte (`.B`) register named **Port_Register** in **LEDs**. (You can specify names of target objects when using FCS. In our example, it is the name of the port register defined by the IO-LED component).

```
#10000 pbits = 3;
```

This line of code sets the three bits of **LEDs.Port_Register** accessed with `pbits` to binary **011**. Other bits are unaffected. The new value of **Port_Register** is `0x75` if the initial value was `0x55`. Values outside the valid `BitRange` of `pbits` are truncated (in this example only values from 0 to 7 are allowed for `pbits`). The `#` means that the time of execution of the instruction is 10000 cycles after the start of the simulation.

```
20000 a = 0;
```

This line of code sets `a` to **0**. Without `#` or `+` in front of the time marker, the time refers to the absolute time after starting execution of the Stimulation file.

NOTE In a periodical loop, the time marker without operator is interpreted as `+`.

```
+20000 b = pbits + 1;
```

ColdFire V1 Full Chip Simulation Connection

True Time I/O Stimulation

This line of code reads `pbits` (three bits in `Leds . Port_Register`), increments this value and writes it to `b`. The `+` in front of the time marker refers to the time relative to the last encountered time value in the Stimulation file.

```
PERIODICAL 100000, 10:
```

This line of code executes the following block 10 times:

```
10000 a = 128;
30000 RAISE 7, 3, "test_interrupt";
```

This starts execution 100,000 cycles after the start of the simulation.

```
10000 a = 128;
```

This line of code assigns **128** to **a**, 10000 cycles after each start of the periodic event.

```
30000 RAISE 7, 3, "test_interrupt";
```

This line of code raises an interrupt with priority 3 with vector number **7**, 40000 cycles after each start of the periodic event. The time specification in the **PERIODICAL** loop is always relative, so **30000** means +30000. The raised interrupt has the name **test_interrupt**. This name is not important for the interrupt functionality.

```
END
```

This line of code is the end of the periodic block. The block loops again after finishing, so the loop restarts after $10000 + 30000 = 40000$ cycles.

```
1000000 RAISE 7, 3, "test_interrupt";
```

This line of code raises the interrupt for the last time. This instruction marks the terminating point of the Stimulation, if there are no pending periodical events left.

Stimulation Input File Syntax

The following listing shows the EBNF input file syntax.

Listing 28.10 EBNF

```
StimulationFile = { IdDeclaration | TimedEvent | PeriodicEvent }.
IdDeclaration = "def" ObjectId "=" ObjectField ";".
ObjectField = ObjectSpec [ "[" BitRange "]" ].
BitRange = StartBit ":" NoOfBits.
```

ColdFire V1 Full Chip Simulation Connection

True Time I/O Stimulation

```

TimedEvent = [ "+" | "#" ] Time AssignmentList.
AssignmentList = { Assignment | Exception}.

PeriodicEvent = "PERIODICAL" Start "," NbTimes ":" { PerTimedEvent }
"END" .
PerTimedEvent = ["+"] Time AssignmentList .

Exception = "RAISE" Vector "," Priority ["," ArbPrio] ["," Name] ";" .
Assignment = ( ObjectId | ObjectField ) "=" Expression ";" .

Name = "" {character} "" .

```

In this listing, the following parameters apply:

- **Expression** = a standard ANSI-C expression. The expression accepts object identifiers previously defined (**ObjectSpec** and **ObjectField**).
- **Time** = a number which represents a number of cycle.
- **ObjectSpec** = the name of an object as defined in Requirement specification for Object Pool.
- **Vector** = the exception vector number.
- **Priority** = the exception priority number.
- **ArbPrio** = the arbitration priority of the exception.
- **Start** = the number of cycle when the periodical event must be called for the first time after the initial time.
- **NbTimes** = the number of times the periodical event must be called (0 = infinity).

Remarks

- Omitting **bitRange** affects all bits of the object register. Specifying **bitRange** applies the mask defined by this **bitRange** to the value calculated with the **Expression**. This value only affects the bits of the object register defined in the **bitRange**.
- Bits are numbered from right to left (in a byte, bit 7 is the left-most bit). In **bitRange**, **noOfBits** is always less than or equal to **StartBit** +1.
- The requirement specification defines **ObjectSpec** for Object Pool as shown below:

```

ObjectSpec ::= ObjectName [ "." FieldName ].
ObjectName ::= Ident [ ":" Index ].
FieldName ::= IdentNum ( [ "." IdentNum ] | [ "." Size ] ).
IdentNum ::= Ident | "#" HexNumber.
Size ::= "B" | "W" | "L".

```

- The identifiers declared in **IdDeclaration** are stored in a table of identifiers and can be also used in **Expression**.
- If “#” is specified, the time is absolute: it is the number of cycles since the Full Chip Simulation was started.
- If “+” is specified, the time is relative to the previous time specification.
- If nothing is specified, time is the number of cycles since execution of the Stimulation file.
- If size is omitted, the default size is byte (B).
- The periodical event is sent for the first time at initial time + start + time specified in periodical timed event.
- In the **PerTimedEvent** declaration, the “+” is optional. If specified or not, the following time is interpreted exactly the same way.
- The periodical events are not displayed in the stimulation screen.

Electrical Signal Generators and Signals Application to Device Pins

Signal IO Component

This **Signal IO** is the first implementation of a **Signal Generator** reading, in real debugger time, a file describing (electrical) levels. Levels are applied and available at a virtual IO pin called **SignalPin** as **float** value.

Levels are programmed one after the other during the debugger internal Event queue of the FCS.

If levels duration value is less than cycle time or smaller than cycles, **undersampling** is performed in the signal file.

You can run up to 16 Signal Generators at the same time.

Signal Description File EBNF

Signal File Format

```
FILELOOP=<INF| nbr of file loops to perform> {signal block}*
EOF
```

Signal Block Description

```
{signal header}  
{signal data}
```

Signal Header Description

```
LOOP=<INF | nbr of file loops to perform>  
TIMEUNIT=<NONE | CYCLES | SECONDS>  
TIMEFACTOR=<double value>  
GAIN=<double value>  
DCOFFSET=<double value>  
OPTION=NORMAL | ONLYPOSITIVE | ONLYNEGATIVE | ABSOLUTE
```

Signal Data Description

```
{<level double value> [<time double value (duration in  
seconds or cycles)>]}*
```

File Example 1

```
FILELOOP=INF  
LOOP=4  
TIMEUNIT=SECONDS  
TIMEFACTOR=0.5  
GAIN=1  
DCOFFSET=0  
OPTION=NORMAL  
0.000000e+000 3.051758e-005  
3.051758e-005 3.051758e-005  
6.103516e-005 3.051758e-005  
9.155273e-005 3.051758e-005  
1.220703e-004 3.051758e-005  
1.525879e-004 3.051758e-005  
1.831055e-004 3.051758e-005  
LOOP=16  
TIMEUNIT=SECONDS
```



```

TIMEFACTOR=3.6
GAIN=-4.2
DCOFFSET=2.5
OPTION=NORMAL
2.136230e-004 3.051758e-005
2.441406e-004 3.051758e-005
2.746582e-004 3.051758e-005
3.051758e-004 3.051758e-005
3.356934e-004 3.051758e-005
3.662109e-004 3.051758e-005
EOF

```

File Example 2

```

FILELOOP=INF
LOOP=INF
TIMEUNIT=NONE
TIMEFACTOR=0.5
GAIN=1
DCOFFSET=0
OPTION=NORMAL
-5
5
2
8
-0.4e-3
300
123
EOF

```

File Parameters

The following parameters apply to the previous code examples.

- LOOP/FILELOOP

ColdFire V1 Full Chip Simulation Connection

Electrical Signal Generators and Signals Application to Device Pins

INF means infinite loop. If a block is INF, scanning stays in this block till the IO is closed or CLOSESIGNALFILE command is executed. If a number is specified, loops that number of times.

- TIMEUNIT
 - CYCLES means that the second data field are cycles.
 - SECONDS means that the second data field are seconds.
 - -NONE means that the second data field does not exist and the data time unit is forced to 1 second. Then data time unit can then be adjust by the TIMEFACTOR parameter.
- TIMEFACTOR

At event programming, multiplies the number of cycles or time duration by this factor.
- GAIN

At Pin level setup, multiply the level by this gain.
- DCOFFSET

At Pin level setup, level offset applied after gain is applied.
- OPTION
 - NORMAL: do nothing.
 - ONLYPOSITIVE: at Pin level setup, after gain and offset, cleared to 0 if signal level < 0.
 - ONLYNEGATIVE: at Pin level setup, after gain and offset, cleared to 0 if signal level > 0.
 - ABSOLUTE: at Pin level setup, after gain and offset, set `|signal level|`.

Signal IO Usage

The Signal IO can handle 16 signals at the same time. Each signal block is independent in parameters and options from other blocks. You can open the Signal component within [Open I/O Component Dialog Box](#) or with the `openio` signal command. Release it within the same dialog or with the `close` signal command.

Signal Commands

The following signal commands are available in FCS:

SETSIGNALFILE Command

SETSIGNALFILE specifies the signal file to use.

The SETSIGNALFILE X command creates a virtual SignalGeneratorX module having a SignalPin.

The file name can include the path of the file. If no path is given, the Signal component will first search in the current project folder, then in the prog\FCSsignals folder of the debugger installation path.

Syntax

```
SETSIGNALFILE <value (0-15)> <"file name">
```

Example

To create three generators:

```
setsignalfile 0 "sinus_11bit_0_5v_1Hz.txt"
setsignalfile 1 "saw_11bit_0_5v_1Hz.txt"
setsignalfile 2 "square_1_5v_1Hz.txt"
```

Then, perform virtual pin connections with the [Pinconn IO](#) CONNECT command:

```
connect "SignalGenerator0.SignalPin", "Atd0.PAD0"
connect "SignalGenerator1.SignalPin", "Atd0.PAD1"
connect "SignalGenerator2.SignalPin", "Atd0.PAD2"
```

TIP Commands to create a signal generators can be placed in a command file like a Postload command file.

CLOSESIGNALFILE Command

CLOSESIGNALFILE closes the current signal file and generator.

Syntax

```
CLOSESIGNALFILE <value (0-15)>
```

Example

```
CLOSESIGNALFILE 1
```

ColdFire V1 Full Chip Simulation Connection

Electrical Signal Generators and Signals Application to Device Pins

Remarks

A message box appears showing the line error in the case of a signal file scripting error.

The Signal component is compatible with cycle time duration modification (bus speed change via PLL) and the True Time feature, and automatically reprograms level duration (when duration in seconds is provided or no duration information is provided).

Currently, all header parameters are mandatory, as well as EOF, in the same order as described in EBNF above, **without spacing between words**.

Base Signal Files Provided

You can reuse the following files to create more complex signal descriptions. They can be found in the `prog\FCSsignals` folder of the debugger installation path.

- `saw_11bit_0_5v_1Hz.txt`: a sawtooth signal, with an 11-bit sampling definition, scaled on a 1 Hz frequency, in a 0 to 5 Volts voltage range.
- `saw_8bit_0_5v_1kHz.txt`: a sawtooth signal, with an 8-bit sampling definition, scaled on a 1000 Hz frequency, in a 0 to 5 Volts voltage range.
- `sinus_11bit_0_5v_1Hz.txt`: a sinus signal, with an 11-bit sampling definition, scaled on a 1 Hz frequency, in a 0 to 5 Volts voltage range.
- `sinus_8bit_0_5v_1kHz.txt`: a sinus signal, with an 8-bit sampling definition, scaled on a 1000 Hz frequency, in a 0 to 5 Volts voltage range.
- `square_1_5v_1Hz.txt`: a pure square signal, scaled on a 1 Hz frequency, with 1 volt at low level and 5 volts at high level.
- `square_1_5v_1kHz.txt`: a pure square signal, scaled on a 1000 Hz frequency, with 1 volt at low level and 5 volts at high level.

Virtual Wire Connections with the Pinconn IO Component

This section describes the Pinconn IO Component and using the Pinconn IO Component to make virtual wire connections.

Pinconn IO

Use the Pinconn IO component to create virtual links or shortcuts between processor device pins, like a simple wire. Open the Pinconn component within [Open I/O Component Dialog Box](#) or with the `openio pinconn` command. Release it within the same dialog or with the `close pinconn` command.

WARNING! It is the user's responsibility to properly connect input pins to output pins without bus or level conflicts.

Pinconn Commands

CONNECT

Connects output pin to input.

Syntax

```
CONNECT "<OutputPin>", "<InputPin>"
```

Example

```
CONNECT "Pim.PORThPin0", "Pim.PORTPPin3"
```

DISCONNECT

Removes connection between pins.

Syntax

```
DISCONNECT "<OutputPin>", "<InputPin>"
```

Example

```
DISCONNECT "Pim.PORThPin0", "Pim.PORTPPin3"
```

CONNECT_STATE

Displays the list of active connections.

NOTE There is no limitation of connections.

NOTE The **Inspect** component provides this list of simulated pins for a derivative FCS under the **Object Pool** key.

Command Set to Apply Signal on ATD Pin

The following example loads the Pinconn and Signal IO components, and creates a signal generator generating the signal described in `square_1_5v_1kHz.txt`. The generator output signal pin connects to the on-chip **ATD** via the **PAD0** pin.

```
openio Pinconn
openio Signal
setsignalfile 0 "square_1_5v_1kHz.txt"
connect "SignalGenerator0.SignalPin", "Atd0.PAD0"
```

FCS Tutorials

This section contains tutorials using the Full Chip Simulation. The tutorial is divided into small steps. Completing the last step creates a fully functional example.

This section contains the following subsections:

- [Guess the Number](#)
- [PWM Sample](#)

Guess the Number

This tutorial uses the SCI and a terminal window from the debugger. At the end the user can guess a number between 0 and 9. This guessing is done via terminal window. The final application runs on real hardware as well.

Step 1 - Environment Setup

- The tutorial uses Processor Expert. You can get a free Processor Expert license (Special Edition) from www.codewarrior.com.
- To run the produced example on real hardware, you need a serial cable. This cable must connect COM1 (PC) with the SCI1 (Hardware Board).

Step 2 - Create the project

1. Launch the **CodeWarrior IDE**
2. In the CodeWarrior menu, Select **File > New Project**
3. Select a derivative like **ColdFire V1 / MCF51QE Family / MCF51QE128**
4. Select **Full Chip Simulation** and click **Next**
5. Enter a project name like **MyGuessTheNumber**

6. Change the directory if you want (**Location > Set**)
7. Check **C** for the language and click **Next**.
8. Click **Next** again (you do not want to add additional files)
9. Choose **Processor Expert** and click **Next**.
10. Click **Finish** to stay with the default options.

The CodeWarrior software creates a new project using the wizard, and Processor Expert is available. During this process, several windows may appear, allowing you to select additional options. Close these windows to keep the default settings. Several Processor Expert windows are visible:

Figure 28.75 Created Project

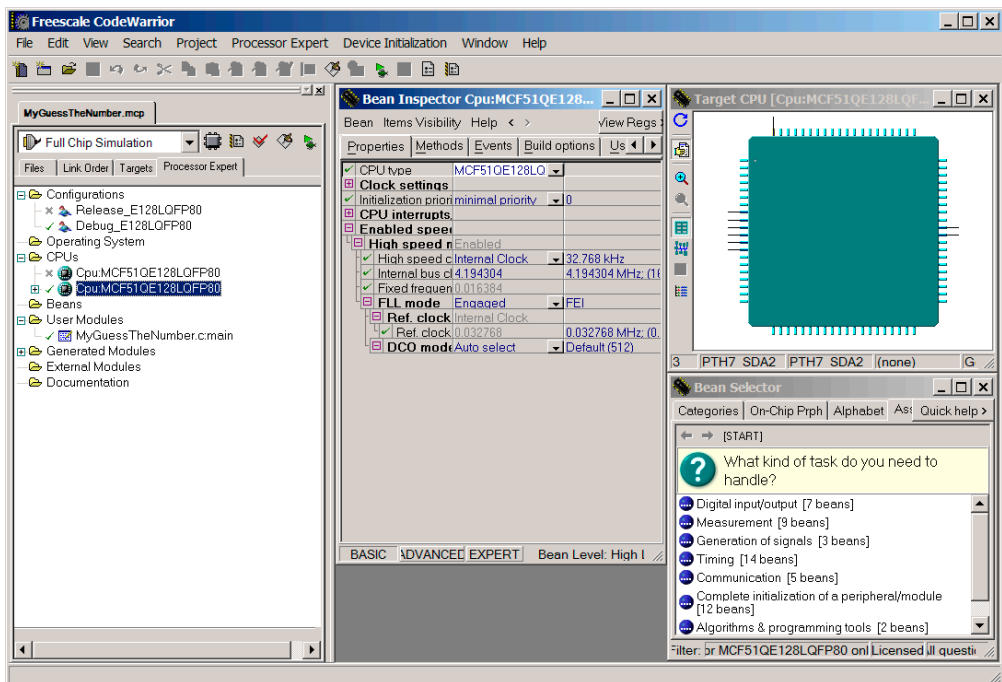

Step 3 - Target CPU Window

The **Target CPU** window in the center shows a footprint of the processor selected for the development. You may increase the size of the Target CPU window to display more details. In the device, we see the different on-chip modules such as CPU, Timer, and ADC. Modules with an icon attached to them are modules used by the application. The pins that are used to connect external functions are indicated by a line and an icon symbol of the function attached (CPU and Port A).

Figure 28.76 Target CPU Window

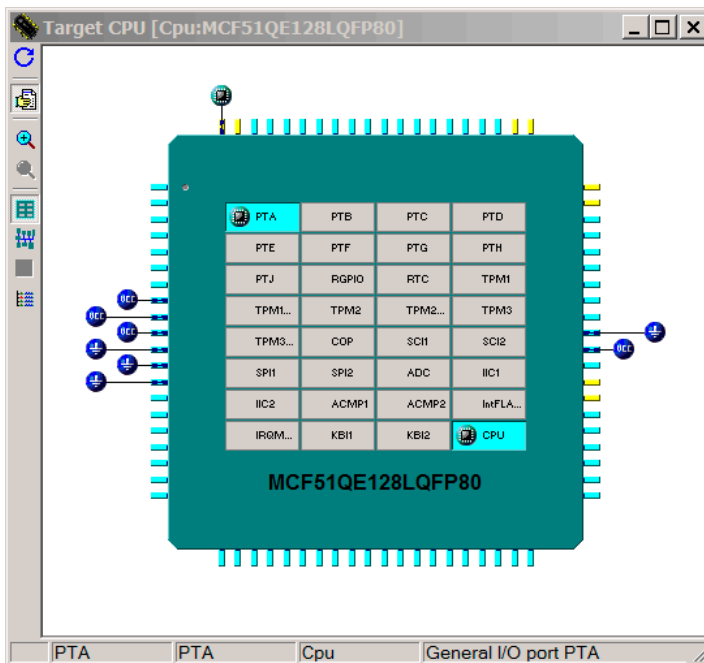

Optional:

- Place the cursor of the mouse on the pins to see a description of their functions.
- Enlarge the Target CPU window to see different on-chip modules.

Step 4 - Bean Selector Window

The **Bean Selector** window offers the developer a list of beans to add to the project. Some of the beans may not be usable with the version of CodeWarrior IDE installed. The

Standard and Professional Editions offer a wider range of hardware and software beans than the Special Edition.

- Select **Bean Categories > CPU internal peripherals > Communication > AsynchroSerial**
- In the context menu select **Add Bean to the Current Project** to add an instance of the AsynchroSerial bean to the project.

Figure 28.77 Bean Selector Window - Selection of AsynchroSerial Bean

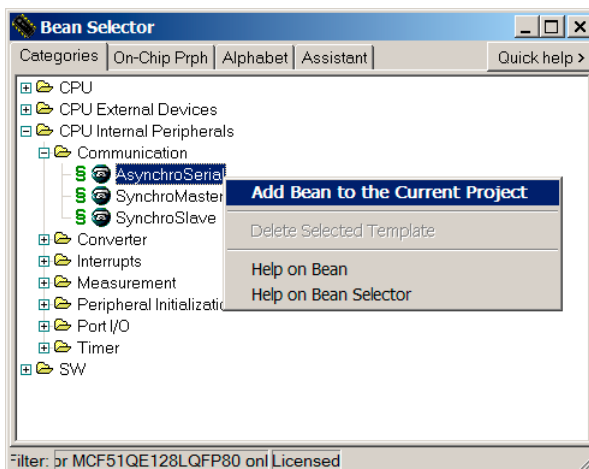

Step 5 - Project Panel Window

The **Project Panel** window shows and keeps track of the beans created for this application. This Panel is a tab of the Project Manager window. A click on the [+] next to a bean shows a list of methods and/or events related to the bean. A green tick indicates whether the named method or event is selected and a red cross indicates that code has not been generated.

ColdFire V1 Full Chip Simulation Connection

FCS Tutorials

Figure 28.78 Project Window - Processor Expert Tab

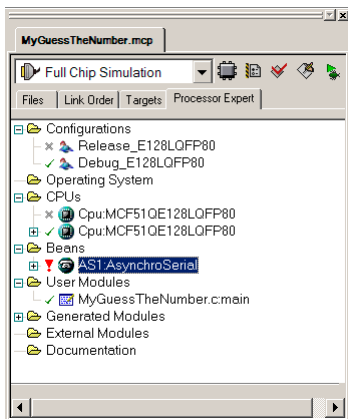

Under **Beans** you can find the previously created bean with the name **AS1:AsynchroSerial**.

Step 6 - Bean Inspector AS1:AsynchroSerial Window

In this window you can modify the behavior of the bean to suit your needs. General settings are in the **Properties** tab. Software drivers are located under the tab **Methods** and **Events**.

- Select **Properties** tab
- Enter a proper **baud rate**. If you want to run it on real hardware check your board manual for the right value. If you want to run it in FCS only you can enter **9600**.

Figure 28.79 Bean Inspector Window

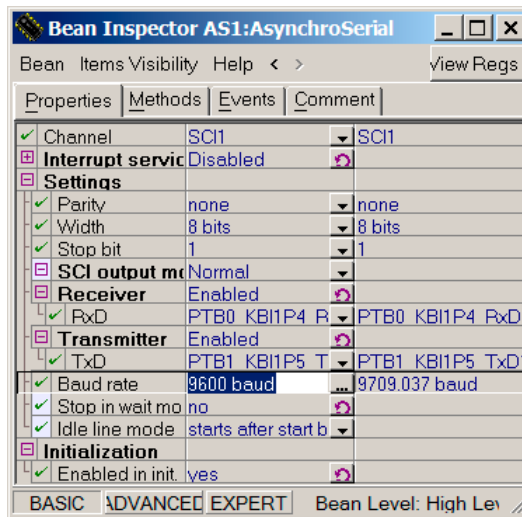

Step 7 - Generation of Driver Code

We are going to generate the code for the I/O drivers and the files for the user code.

- Select the **Make** icon in the Project Manager window (or the menu bar **Project > Make** or [F7]).

Processor Expert shows several messages. One message indicates that we have started the code generation. The second message shows the progress with the information processed and the code generated. A window shows compiling and linking progress.

Step 8 - Verification of Files Created

Select the **Files** tab to display all the Project files. We can verify the folders and files created by Processor Expert:

- User Modules

A file `MyGuessTheNumber.C` is the placeholder for the main procedure and any other procedure desired by the user. You can place these other procedures in additional files.

- Generated Code

This is the `.C` files for the code associated with the beans added to the project. This includes initialization, input, output and the declarations necessary for using the functions.

Step 9 - Entering User Code

1. Open the user module **MyGuessTheNumber.C**
2. Insert the following code **before** the main routine:

```
#include <stdlib.h>
void PutChar(unsigned char c) {
    while (AS1_SendChar(c) == ERR_TXFULL) {
        // could wait a bit here
    }
}
void PutString(const char* str) {
    while (str[0] != '\0') {
        PutChar(str[0]);
        str++;
    }
}

void GuessTheNumber(void) {
    int ran = rand() / (RAND_MAX / 9);
    AS1_Init();

    PutString("Guess a Number between 0 and 9\n");
    PutString("Number: ");
    for (;;) {
        unsigned char c;
        if (AS1_RecvChar(&c) == ERR_OK) {
            PutChar(c); PutChar(' ');
            if(c < '0' || c > '9') {
                PutString("not a number, try again\n");
            } else if(c == ran + '0') {
                PutString("\nCongratulation! You have found the number!");
                PutString("\nGuess a new number\n");
                ran = rand() / (RAND_MAX / 9);
            } else if(c > ran + '0') {
                PutString("lower\n");
            } else {
                PutString("greater\n");
            }
            PutString("Number: ");
        } else {
            // could wait a bit here
        }
    } // for
}

```

3. Call the function **GuessTheNumber** in the main routine.

```
void main(void) {
    /*** Processor Expert internal initialization. DON'T REMOVE THIS
    CODE! ***/
    PE_low_level_init();
    /*** End of Processor Expert internal initialization.      ***/

    /*Write your code here*/
    GuessTheNumber();

    /***Processor Expert end of main routine. DON'T MODIFY THIS CODE!***/
    for(;;);
    /***Processor Expert end of main routine. DON'T WRITE CODE BELOW!***/
} /*** End of main routine. DO NOT MODIFY THIS TEXT! ***/
```

Step 10 - Run

The application is now complete and we can launch it. Make sure you have chosen the Full Chip Simulation connection.

1. Select the **Debug** icon in the Project Manager window (or the menu bar **Project > Debug** or [F5]).
If there are compilation errors, correct your source code and try again.
2. In the Debugger, select **Component > Open** in the debugger and open the **Terminal** component.
3. From the context menu of the Terminal window select **Configure Connections** and change the name of the SCI peripheral to SCI1 (the SCI you chose in the previous Processor Expert bean configuration).

ColdFire V1 Full Chip Simulation Connection

FCS Tutorials

Figure 28.80 Terminal Configuration Dialog

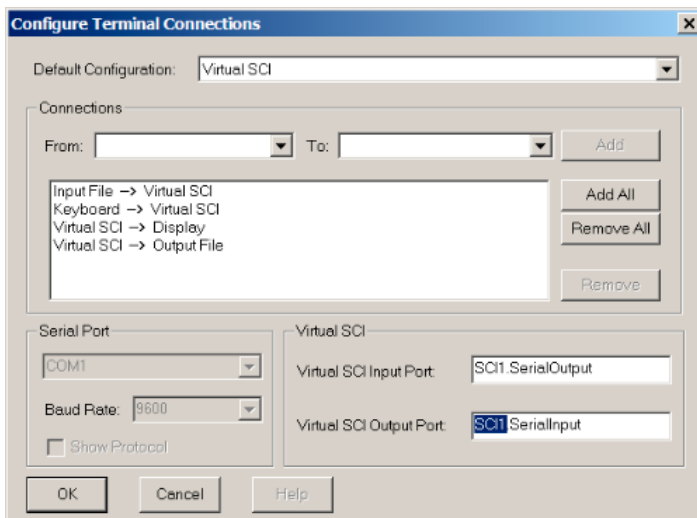

4. Select the **Save** icon in the debugger (or the menu bar **File > Save Configuration**) to save the window layout.
5. Select the **Run** icon in the debugger (or the menu bar **Run > Start/Continue** or **[F5]**).
6. Enter numbers in the terminal window to guess the right number.

Figure 28.81 Debugger Main Window - Final Application

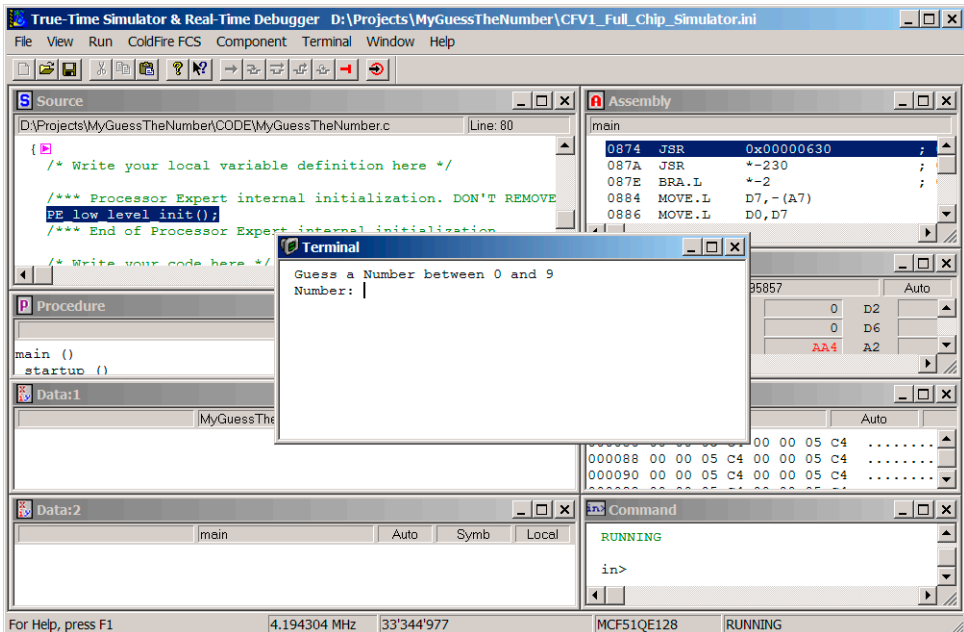

PWM Sample

This application uses the PWM. With the final application you will be able to change the period and duty time of the PWM and see the changes displayed in a chart.

Step 1 - Environment Setup

- The tutorial uses Processor Expert. You can get a free Processor Expert license (Special Edition) from www.codewarrior.com.

Step 2 - Creating Project

1. Launch the CodeWarrior IDE
2. In the CodeWarrior menu, Select **File > New Project**
3. Select a derivative like **ColdFire V1 / MCF51QE Family / MCF51QE128**
4. Select **Full Chip Simulation** and click **Next**

ColdFire V1 Full Chip Simulation Connection

FCS Tutorials

5. Enter a project name like **PWM_Sample**
6. Change the directory if you want (**Location > Set**)
7. Check **C** for the language and click **Next**.
8. Click **Next** again (you do not want to add additional files)
9. Choose **Processor Expert** and click **Next**.
10. Click **Finish** to keep the default options.

The debugger creates a new project using the wizard and Processor Expert is available. During this process, several windows appear, allowing you to select additional options. Close these windows to retain the default settings. Several Processor Expert windows are visible.

Step 3 - Target CPU Window

The *Target CPU* window in the center shows a footprint of the processor selected for the development. In the device, we see the different on-chip modules such as CPU, Timer, and the ADC. Modules with an icon attached to them are modules used by the application. The pins that are used to connect external functions are indicated by a line and an icon, symbol of the function attached (CPU and Port A).

Optional:

- Place the cursor of the mouse on the pins to see a description of their functions.
- Enlarge the **Target CPU** window to see different on-chip modules.

Step 4 - Creating PWM Bean

- Select **Bean Categories > CPU internal peripherals > Timer > PWM**
- In the context menu select 'Add Bean to the Current Project' to add an instance of the AsynchroSerial bean to the project.

Step 5 - Project Panel Window

The **Project Panel** window shows and keeps track of the beans created for this application. This Panel is a tab of the Project Manager window. Click on the [+] next to a bean to show a list of methods and/or events related to the bean. A green tick indicates whether the named method or event is selected and a red cross indicates that code has not been generated.

Locate the previously created bean with the name **PWM1:PWM** under *Beans*.

Step 6 - Bean Inspector PWM1.PWM

In the Bean Inspector window you can modify the behavior of the bean to suit your needs. General settings can be changed in the **Properties** tab. Software drivers are found under the **Methods** and **Events** tabs.

- Select **Properties** tab
- Select **Period** and enter **200 ms**
- Select **Starting pulse width** and enter **10 ms**

Step 7 - Generate Driver Code

Now generate the code for the I/O drivers and the files for the user code.

- Select the **Make** icon in the Project Manager window (or the menu bar **Project > Make** or [F7]).

Processor Expert shows several messages. One message indicates that we have started the code generation. The second message shows the progress with the information processed and the code generated. A window shows compiling and linking progress.

Step 8 - Verification of Files Created

Select the **Files** tab to display all the Project files. We can verify the folders and files created by Processor Expert:

- User Modules
A file `PMW_Sample.C` is the placeholder for the main procedure and any other procedure desired by the user. You can place these other procedures in additional files.
- Generated Code
These are the `.C` files for the code associated with the beans added to the project. This includes initialization, input, output and the declarations necessary for using the functions.

Step 9 - Entering User Code

- Open the user module `PMW_Sample.C`
- Replace the main routine with the following **code**:

```
volatile static unsigned int pwmRatio= 6939;  
  
void main(void) {
```

ColdFire V1 Full Chip Simulation Connection

FCS Tutorials

```

    /*** Processor Expert internal initialization. DON'T REMOVE THIS
CODE! ***/
    PE_low_level_init();
    /*** End of Processor Expert internal initialization.    ***/

    /*Write your code here*/
    for(;;) {
        (void)PWM1_SetRatio16(pwmRatio);
    }

    /***Processor Expert end of main routine. DON'T MODIFY THIS CODE!***/
    for(;;);
    /***Processor Expert end of main routine. DON'T WRITE CODE BELOW!***/
} /*** End of main routine. DO NOT MODIFY THIS TEXT! ***/

```

Step 10 - Run

The application is now finished and we can launch it. Make sure you have chosen the Full Chip Simulation connection.

1. Select the **Debug** icon in the Project Manager window (or the menu bar **Project > Debug** or [F5]).
2. Select **Component > Open** in the debugger and open the **VisualizationTool** component.

VisualizationTool Properties

In this tutorial we will create a visualization using the VisualizationTool window. Make sure that you are in the **Edit mode** (**Right mouse click > Edit Mode** or [Ctrl-E]).

1. Select **Right mouse click > Properties**
2. For **Refresh Mode**, select **CPU Cycles**
3. For **Cycle Refresh Count**, select **10000**

Chart Properties

Now add a chart, where we can see the changing value of the channel in a graphic.

1. **Right mouse click > Add New Instrument > Chart**
2. **Double click** on the Chart to see the Chart Properties.
3. Select **Subscribe** for **Kind of Port**
4. Use **PIM.PTA0** for **Port to Display** (this is the simulated pin of the device)
5. Select **2** for **High Display Value**

6. Select **Target Periodical** for **Type of Unit**
7. Select **1000** for **Unit Size**
8. Select **2000** for **Numbers of Units**
9. Leave all others on default.

Duty Time Bar Properties

Now add a bar to change the duty time.

1. **Right mouse click > Add New Instrument > Bar**
2. **Double click** on the Bar to see the Bar Properties.
3. Select **Variable** for **Kind of Port**
4. Select **pwmRatio** for **Port to Display**
5. Select **65535** for **High Display Value**
6. Leave all others on default.

You might add labels with **Right mouse click > Add New Instrument > Static Text**.

Now leave the Edit mode and run the final application. First, save the window layout.

1. **Right mouse click > Edit Mode** (or [Ctrl-E])
2. Select the **Save** icon in debugger (or the menu bar **File > Save Configuration**) to save the window layout.
3. Select the **Debug** icon in debugger (or the menu bar **Run > Start/Continue** or [F5]).

ColdFire V1 Full Chip Simulation Connection

FCS Tutorials

Figure 28.82 Debugger Main Window - Final Application

The screenshot displays the True-Time Simulator & Real-Time Debugger interface. The main window is titled "True-Time Simulator & Real-Time Debugger" and shows the following components:

- Source Window:** Displays C code for a PWM sample. The current line is 105, which is highlighted:

```
TPM1C0V = (word)((0xCCCDUL * (dword)RatioStore) >> 0x10);
```
- Assembly Window:** Shows the assembly code for the "SetRatio" function. The instruction at address 0704 is highlighted:

```
0704 MOVE.W D1,0xFFFF8046
```
- VisualizationTool Window:** A modal window titled "VisualizationTool" is open, showing a graph of the duty cycle for "TPM CH0". The graph shows a square wave. The "Duty Time:" slider is set to 0%, and the status bar indicates "No Instrument selected".
- Register Window:** Shows CPU cycles: 713830077. A table of registers is visible:

10	D1	33E6	D2
0	D5	0	D6
0	A1	85C	A2
0	A5	800008	A6
- Command Window:** Shows the command prompt with the text:

```
STOPPING
HALTED
in>
```
- Status Bar:** At the bottom, it shows "For Help, press F1", "4.194304 MHz", "713'830'077", "MCF51QE128", and "HALTED".

ColdFire P&E Multilink/ Cyclone Pro Connection

This chapter guides you through the first steps toward debugging with the CodeWarrior™ IDE and the *P&E Multilink/Cyclone Pro* connection for ColdFire®. It does not replace all the additional documentation provided in this manual, but gives you a good starting point.

P&E Multilink/Cyclone Pro Technical Considerations

The 8/16/32 bits debugger (and then the CodeWarrior IDE) might be connected to ColdFire hardware using the P&E Multilink Cyclone Pro connection.

When the debugger runs the **P&E Multilink/Cyclone Pro** connection, it can communicate and debug **ColdFire V1** core-based hardware connected through the P&E BDM Multilink interface or through the P&E Cyclone Pro interface.

NOTE The BDM Multilink (parallel port) and USB-ML-12 Rev. A are no longer supported in ColdFire V1.

CodeWarrior IDE and P&E Multilink/Cyclone Pro Connection

There are two separate paths that may be followed to take the first steps toward debugging with the CodeWarrior IDE and the P&E Multilink/Cyclone Pro connection. The differences between the two paths hinge on the starting point for the steps:

- Using the Stationary Wizard at the start of the project
- From within an existing project

First Steps Using the Stationery Wizard

To take the first steps toward debugging with the CodeWarrior IDE and the P&E Multilink/Cyclone Pro using the stationery Wizard:

1. Run the CodeWarrior IDE with the shortcut created in the program group.
2. In the *Microcontrollers New Project Wizard*, follow the path to create a new project, naming the project.
3. Click the *Next* button to open the New Project window.
4. In the *Microcontrollers New Project* window, choose the ColdFire Family chip you are working with from the list in the Derivative list box.

Figure 29.1 Wizard Connection Selection

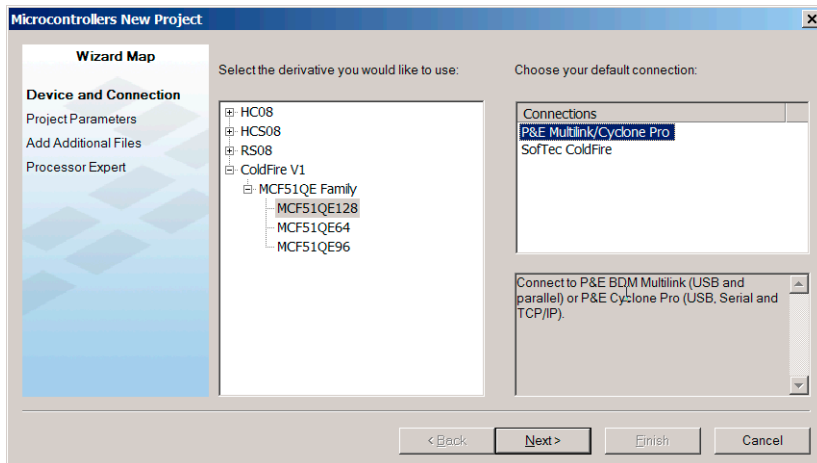

5. From the Default Connection list box, choose the connection **P&E Multilink/Cyclone Pro** to create a new project from this stationery.
6. Click the *Finish* button - the CodeWarrior IDE opens.
7. Choose the menu option *Project > Make*.
8. Choose the menu option *Project > Debug* to start the debugger.
9. Start debugging.

First Steps From Within an Existing Project

To take the first steps toward debugging with the CodeWarrior IDE and setting the P&E Multilink/Cyclone Pro connection from within an existing debugging project:

1. Run the CodeWarrior IDE with the shortcut created in the program group.
2. Open the project.
3. Choose *Project > Debug* to start the debugger.
4. In the debugger choose *Component > Set Connection* to select another target interface in the Set Connection dialog box.
5. Select *ColdFire* as the Processor then *P&E Multilink/Cyclone Pro* as the connection.

Figure 29.2 Set Connection Dialog Box - P&E Multilink/Cyclone Pro Selection

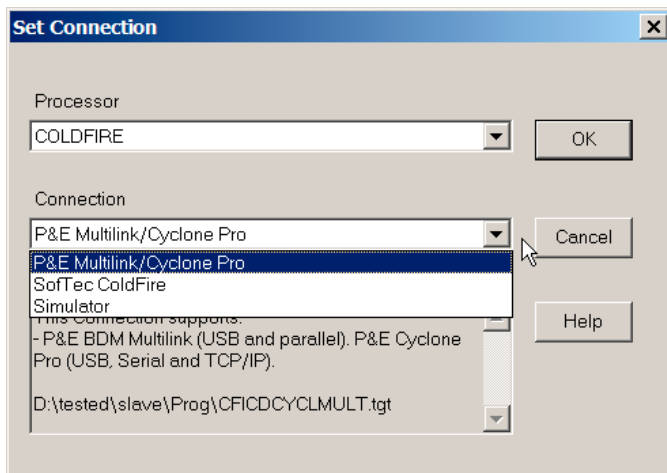

6. Press the *OK* button - Set Derivative dialog box opens.
7. In the *Set Derivative* dialog box, choose the correct target processor.

ColdFire P&E Multilink/Cyclone Pro Connection

First Steps From Within an Existing Project

Figure 29.3 Set Derivative Dialog Box

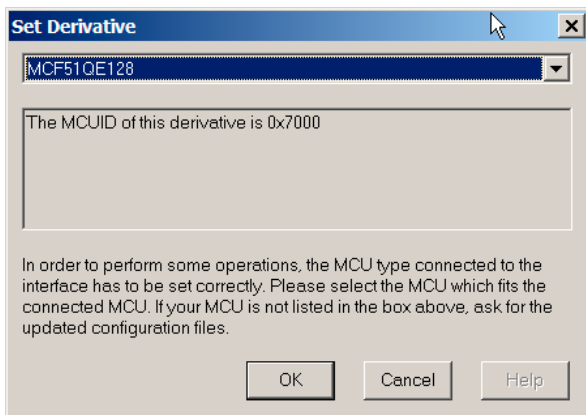

8. Press the *OK* button - The Connection Manager dialog box opens.
9. Select the P&E interface and port. Press the Connect button to start debugging.

Figure 29.4 Connection Manager Dialog Box

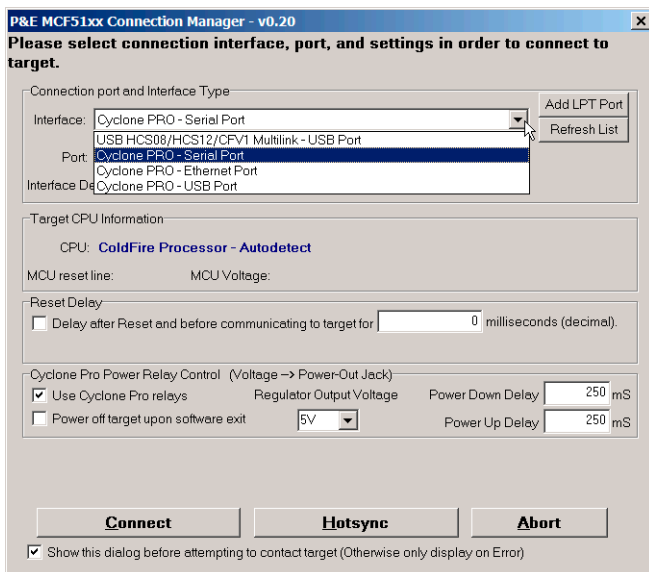

P&E Multilink/Cyclone Pro Menu Options

Once the P&E Multilink/Cyclone Pro connection is set, the connection menu entry in the debugger main toolbar changes to **CFMultilinkCyclonePro**.

Figure 29.5 P&E Multilink/Cyclone Pro Menu Options

CFMultilinkCyclonePro	Component	Co
Load...	Ctrl+L	
Reset	Ctrl+R	
Setup...		
Communication...		
Select Derivative...		
Command Files		
Debugging Memory Map...		
Trigger Module Settings...		
Bus Trace		
Flash...		

Setup

Select *MultilinkCyclonePro* > *Setup* to display the [P&E Multilink/Cyclone Pro Setup Dialog Box](#).

Connect/Communication

Select *MultilinkCyclonePro* > *Connect* or *Communication* to display the [Connection Manager Dialog Box](#).

Select Derivative

Select *MultilinkCyclonePro* > *Select Derivative* to display the [Set Derivative Dialog Box](#).

Debugging Memory Map

Select *MultilinkCyclonePro* > *Debugging Memory Map* to display the Debugging Memory Map dialog. For more information about the *Debugging Memory Map* menu option, see Debugging Memory Map window.

Trigger Module Settings

Select *MultilinkCyclonePro > Trigger Module Settings* to open the Trigger Module Settings dialog. Refer to the *Debugger ColdFire On-chip DBG Module User Interface* manual for all related information.

Bus Trace

Select *MultilinkCyclonePro > Bus Trace* to open the Trace component window within the debugger main window. Refer to the *Debugger ColdFire On-chip DBG Module User Interface* manual for all related information.

Flash

Select *MultilinkCyclonePro > Flash* to open the Non-Volatile Memory Control dialog box. For more information see [Flash Programming](#).

P&E Multilink/Cyclone Pro Setup Dialog Box

In the communication tab, the communication protocol between the debugger and P&E driver display can be activated. The protocol is displayed in the Command window. Use this option only when requested by the Support team.

Figure 29.6 P&E Multilink/Cyclone Pro Setup Dialog Box - Communication Tab

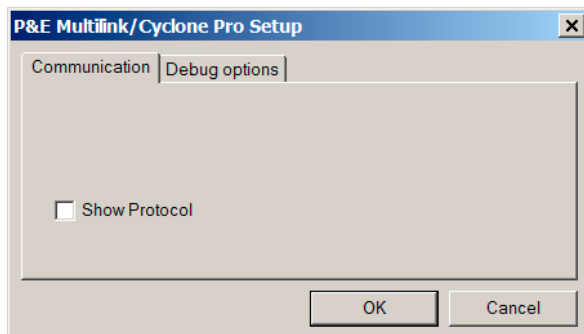

In the communication tab, checking **Disable maskable ISR's when stepping** option provides a way to debug without diving in pending program ISR's. When this option is set, interrupts are masked before stepping as if changing directly the interrupt level in the SR core register. When the step is performed, the interrupt level is reverted to previous state, and if necessary, adjusted according to last executed instruction (when the stepped instruction affects the interrupt level).

When checking “Program trim data open application loading”, the P&E driver calculates the data to be Flashed to trim the device according to trimming information provided in the Communication Settings dialog. The debugger programs automatically this data to the device Flash when an application is loaded.

When checking “Enable Terminal Printf Support”, the debugger handles hardware background breaks and checks if the application is broadcasting a message to the debugger. In this case, the debugger forwards the message to the Terminal window, and the debugger runs again the target application. When not checked, the debugger remains halted and reports an unknown hardware break status. To emulate a Terminal communications, use the special libraries delivered with the CodeWarrior IDE.

Figure 29.7 P&E Multilink/Cyclone Pro Setup Dialog Box - Debug Options Tab

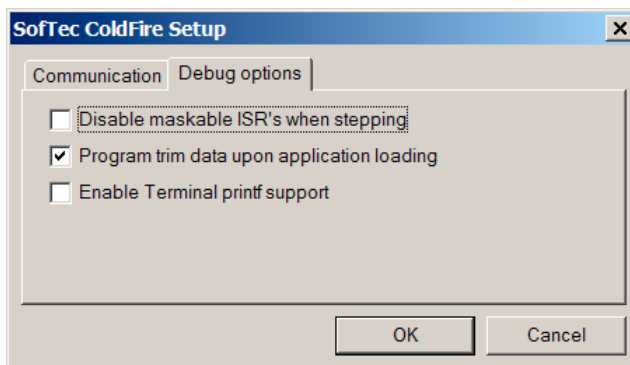

Connection Manager Dialog Box

The **Connection Port and Interface Type** field gives the user the way to select the debugging cable and also the communication port or specific cable when several cables are available.

The **Reset Delay** field provides a way to delay the communication with the hardware.

The **Cyclone Pro Power Control** field provides specific setup for the Cyclone Pro interface. Refer to the P&E Cyclone Pro manual and specifications.

The **Hotsync** button in the Connection Manager allows the user to connect to an already running target.

The **Show this dialog before attempting to contact target** checkbox can be unchecked to remove this dialog window at connection. The dialog still pops up if the connection cannot be opened with any hardware.

ColdFire P&E Multilink/Cyclone Pro Connection

First Steps From Within an Existing Project

Figure 29.8 Connection Manager Dialog Box

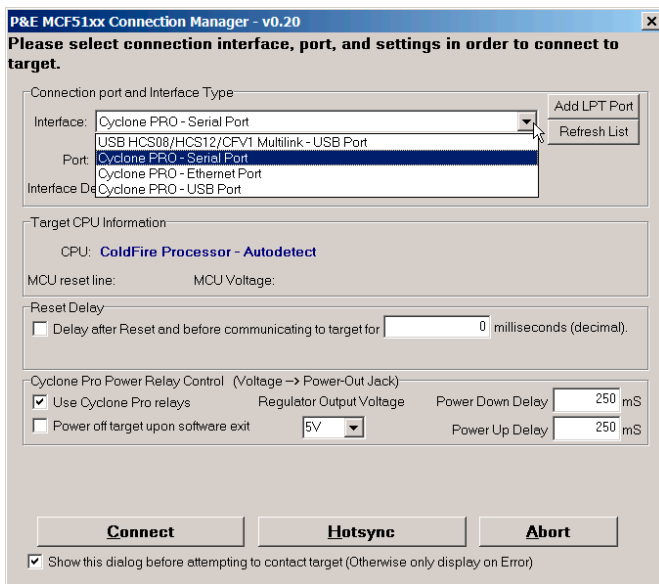

Set Derivative Dialog Box

This dialog box is used to set up a derivative. The list menu can be expanded to select another ColdFire derivative.

Figure 29.9 Set Derivative Dialog Box

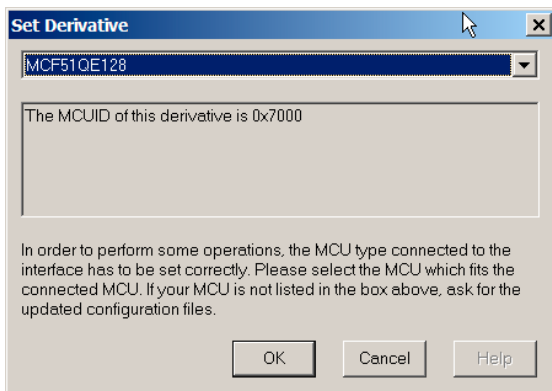

SofTec ColdFire Connection

This chapter guides you through the first steps toward debugging with the CodeWarrior™ IDE and the *SofTec ColdFire* connection. It does not replace all the additional documentation provided in this manual, but gives you a good starting point.

SofTec ColdFire Technical Considerations

The 8/16/32 bits debugger (and then the CodeWarrior IDE) might be connected to ColdFire® hardware using the SofTec ColdFire.

When the debugger runs the **SofTec ColdFire** connection, it can communicate and debug **ColdFire V1** core based hardware connected through the SofTec in-circuit debugger/ programmer units, that is:

SofTec Microsystems ColdFire ISP Debuggers/Programmers (inDART Series) and Starter Kits (PK and newer Series).

Refer to the *inDART®-ColdFire In-Circuit Debugger/Programmer for Freescale ColdFire Family FLASH Devices User's Manual* from SofTec for communication hardware requirements and SofTec product installation.

CodeWarrior IDE and SofTec ColdFire Connection

There are two separate paths that may be followed to take the first steps toward debugging with the CodeWarrior IDE and the SofTec inDART-ColdFire connection. The differences between the two paths hinge on the starting point for the steps:

- Using the Stationary Wizard at the start of the project
- From within an existing project

First Steps Using the Stationery Wizard

To take the first steps toward debugging with the CodeWarrior IDE and the SofTec inDART-ColdFire using the stationery Wizard:

1. Run the CodeWarrior IDE with the shortcut created in the program group.
2. In the *Microcontrollers New Project Wizard*, follow the path to create a new project, naming the project.
3. Click the *Next* button to open the New Project window.
4. In the *Microcontrollers New Project* window, choose the ColdFire Family chip you are working with from the list in the Derivative list box.

Figure 30.1 Wizard Connection Selection

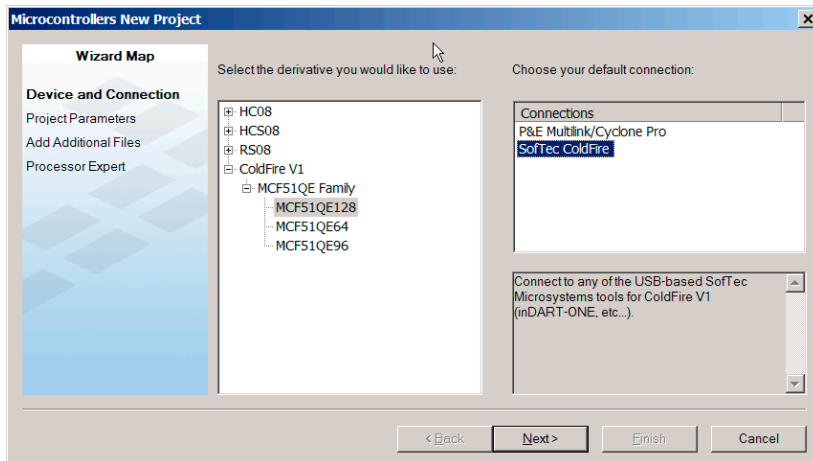

5. From the Default Connection list box, choose the connection **SofTec ColdFire** to create a new project from this stationery.
6. Click the Finish button - the CodeWarrior IDE opens.
7. Choose the menu option *Project > Make*.
8. Choose the menu option *Project > Debug* to start the debugger.
9. Start debugging.

First Steps From Within an Existing Project

To take the first steps toward debugging with the CodeWarrior IDE and setting the SofTec ColdFire connection from within an existing debugging project:

1. Run the CodeWarrior IDE with the shortcut created in the program group.
2. Open the project.
3. Choose *Project > Debug* to start the debugger.
4. In the debugger choose *Component > Set Connection* to select another target interface in the Set Connection dialog box.
5. Select **ColdFire** as the Processor then **SofTec ColdFire** as the connection.

Figure 30.2 Set Connection Dialog Box - SofTec ColdFire Selection

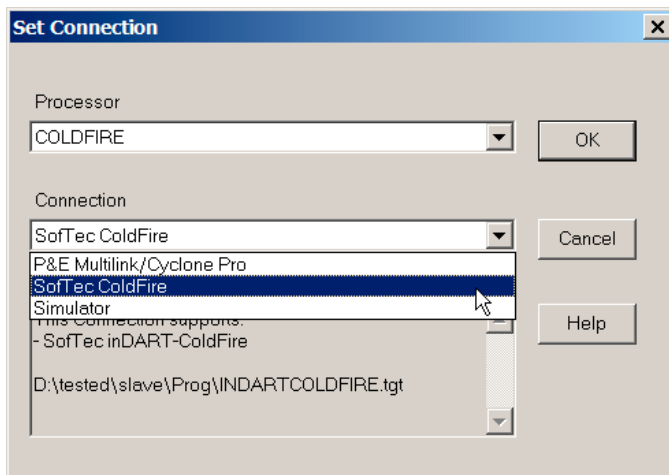

6. Press the *OK* button - Set Derivative dialog box opens.
7. In the Set Derivative dialog box, choose the correct target processor.

SofTec ColdFire Connection

First Steps From Within an Existing Project

Figure 30.3 Set Derivative Dialog Box

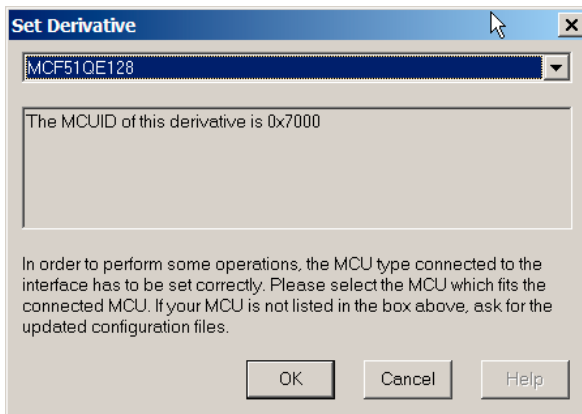

8. Press the OK button - Target Connection dialog box opens.
9. Select the hardware cable model. Press the Connect button to start debugging.

Figure 30.4 Target Connection Dialog Box

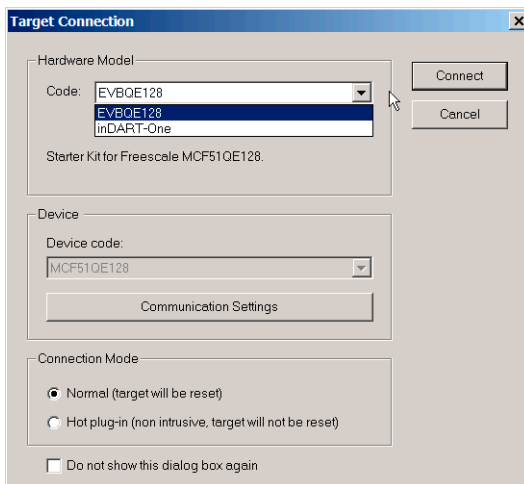

SofTec ColdFire Menu Options

Once the SofTec ColdFire connection is set, the connection menu entry in the debugger main toolbar changes to **SofTec-MCF51**.

Figure 30.5 SofTec-MCF51 Menu Options

SofTec-MCF51	Component	Command
Load...		Ctrl+L
Reset		Ctrl+R
Setup...		
Communication...		
Select Derivative...		
Command Files		
Debugging Memory Map...		
Trigger Module Settings...		
Bus Trace		
Flash...		
About...		

Setup

Select *SofTec-MCF51* > *Setup* to display the [SofTec Coldfire Setup Dialog Box](#).

Communication

Select *SofTec-MCF51* > *Communication* to display the [Target Connection Dialog Box](#).

Select Derivative

Select *SofTec-MCF51* > *Select Derivative* to display the [Set Derivative Dialog Box](#).

Debugging Memory Map

Select *SofTec-MCF51* > *Debugging Memory Map* to display the Debugging Memory Map dialog. For more information about the *Debugging Memory Map* menu option, see Debugging Memory Map window.

Trigger Module Settings

Select *SofTec-MCF51* > *Trigger Module Settings* to open the Trigger Module Settings dialog. Refer to the *Debugger ColdFire On-chip DBG Module User Interface manual* for all related information.

SofTec ColdFire Connection

First Steps From Within an Existing Project

Flash

Select *SofTec-MCF51 > Flash* to open the Non-Volatile Memory Control dialog box. For more information see [Flash Programming](#).

About Option

Select *SofTec-MCF51 > About* to display the [About Dialog Box](#).

Bus Trace

Select *SofTec-MCF51 > Bus Trace* to open the Trace component window within the debugger main window. Refer to the *Debugger ColdFire On-chip DBG Module User Interface manual* for all related information.

SofTec Coldfire Setup Dialog Box

In the communication tab, the communication protocol between the debugger and SofTec driver display can be activated. The protocol is displayed in the Command window. Use this option only on Support team request.

Figure 30.6 SofTec ColdFire Setup Dialog Box - Communication Tab

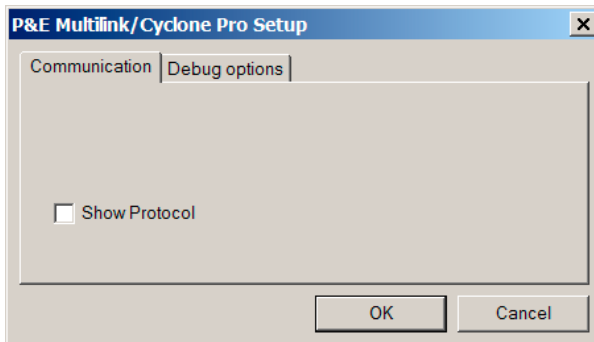

In the Debug Options tab, checking “Disable maskable ISR’s when stepping” option provides a way to debug without diving in pending program ISR’s. When this option is set, interrupts are masked before stepping as if changing directly the interrupt level in the SR core register. When the step is performed, the interrupt level is reverted to previous state, and if necessary, adjusted according to last executed instruction (when the stepped instruction affects the interrupt level).

When checking “Program trim data open application loading”, the SofTec driver calculates the data to be Flashed to trim the device according to trimming information

provided in the Communication Settings dialog. The debugger programs automatically this data to the device Flash when an application is loaded.

When checking “Enable Terminal Printf Support”, the debugger handles hardware background breaks and checks if the application is broadcasting a message to the debugger. In this case, the message is forwarded to the Terminal window, and the debugger runs again the target application. When not checked, the debugger remains halted and reports an unknown hardware break status. To emulate a Terminal communications, use the special libraries delivered with CodeWarrior IDE.

Figure 30.7 SofTec ColdFire Setup Dialog Box - Debug Options Tab

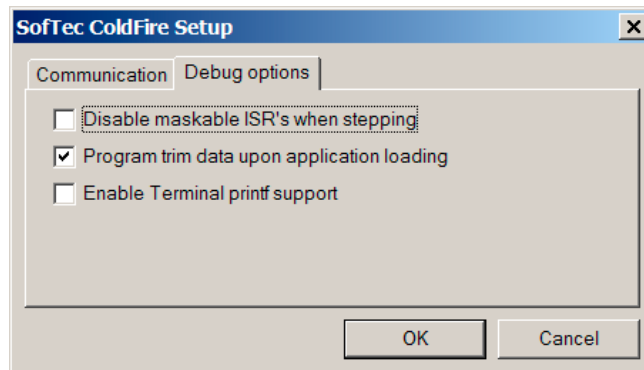

Target Connection Dialog Box

The SofTec debug cable or target board can be selected in the Hardware Model, *Code* list menu. When an inDART-One model is selected, a *Port* list menu appears to select the exact inDART-One cable by its serial number. A Refresh button is also available to refresh the Port list.

A **Normal** connection mode is selected by default to start debugging a hardware from hardware background reset. When choosing **Hot Plug-in**, the connection synchronizes with the hardware without forcing any background reset. The debugger state synchronizes with the hardware state.

Checking **Do not show this dialog box again** hides this dialog when starting the project.

SofTec ColdFire Connection

First Steps From Within an Existing Project

Press the *Communication Settings* button in this window to open the [Communication Settings Dialog Box](#).

Figure 30.8 Target Connection Dialog Box

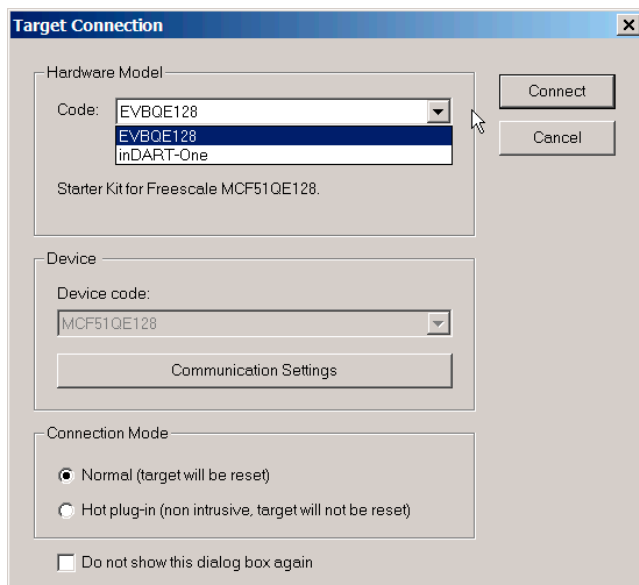

Communication Settings Dialog Box

The BDC Clock (CLKSW) group is intended to setup the best BDC synchronization between the SofTec inDART-ColdFire interface and the target processor.

When **Use system bus frequency** is selected, the BDC communication clock source is the microcontroller's bus frequency; when **Use alternate frequency** is selected, the BDC communication clock source is a constant clock source, which can vary depending on the specific ColdFire derivative.

The dialog may slightly differ according to cable model. For additional options set up within this dialog, refer to the *inDART®-ColdFire In-Circuit Debugger/Programmer for Freescale ColdFire Family FLASH Devices User's Manual* from SofTec.

Figure 30.9 Communication Settings Dialog Box

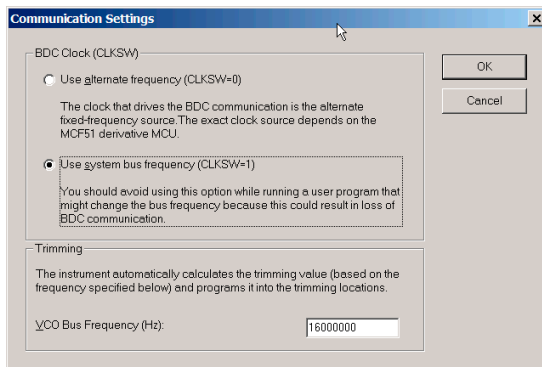

Set Derivative Dialog Box

This dialog box is used to set up a derivative. The list menu can be expanded to select another ColdFire derivative.

Figure 30.10 Set Derivative Dialog Box

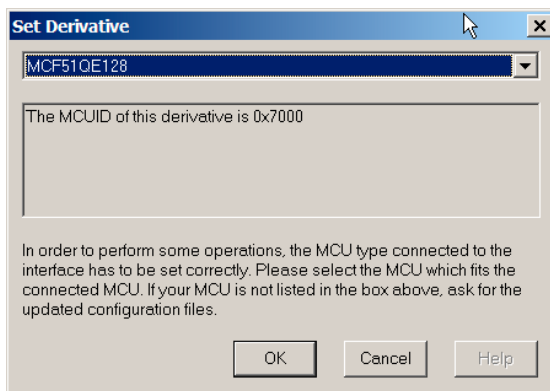

About Dialog Box

This dialog box belongs to the SofTec GDI DLL and provides information about the inDART_CFV1.dll release and version.

Figure 30.11 About Dialog Box

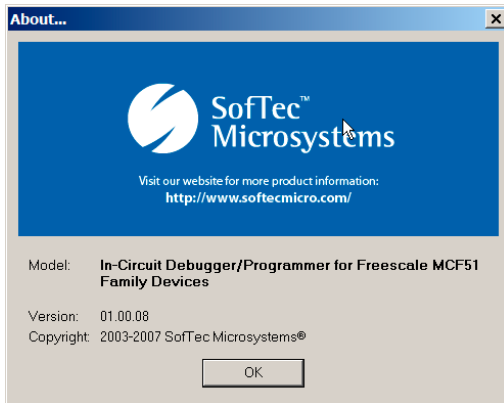

ColdFire On-Chip DBG Module

The ColdFire® derivatives featuring an on-chip debugger (DBG) module require a debugger graphical user interface to setup this module and take full advantage of this enhanced debugging feature. This manual describes the DBG module user interface.

Within several ColdFire debugger connections, a complete graphical user interface is provided, through a trigger setup dialog box combined with context-sensitive context menus (mouse right-click) in Source, Assembly, Data and Memory component windows to set the on-chip DBG module and triggers.

This DBG module support is automatically enabled or disabled, according to user selected derivative (if the device is user configurable) or automatically through device Part ID.

TIP Refer to [HCS08 On-Chip DBG Module](#) for general information. This section gives details of specific setup for the ColdFire debug module.

DBG Features

The debugger covers all features available within the on-chip DBG module:

- Regular hardware breakpoints and watchpoints,
- Predefined preset [Instruction Triggers](#) or [Memory Access Triggers](#), a wide set of complex hardware breakpoints (triggers on program code instructions) and watchpoints (triggers on device memory access) and data bus recording,
- Expert Triggers, as powerful as predefined preset triggers, “Do It Yourself” way,
- Code program flow rebuild from Real Time Trace PST/DATA output signals within the Trace window component (open the Trace component to display the code program flow rebuild),

Typically, the debugger provides four instruction hardware breakpoints, and one watchpoint. When setting triggers (A or/and B or/and C), the debugger still allows to set two instruction hardware breakpoints.

Triggers A and B relate to the program counter, whereas Trigger C relates to memory operations.

Context Menu Entries in Source, Data, Assembly and Memory Windows

In the Data and Memory windows, only the Trigger C is available in the context sensitive context menu, to set watchpoints. In the Source and Assembly windows context sensitive context menu, Trigger A and B can be selected to set breakpoints.

Specific DBG support menu options are added to the Connection menu as soon as the debugger target processor is acknowledged by the DBG module.

The DBG module Sequencer setup can be set directly via the context sensitive context menu, “Sequencer Setup” menu entry.

The recording mode can also be set when selecting the “Trace Setup” menu entry.

The “Trigger Module Usage” entry provides a straight-forward way to switch between the Automatic, User Triggers, Expert, and Profiling/Coverage mode.

Figure 31.1 Source Context Menu - Added Options

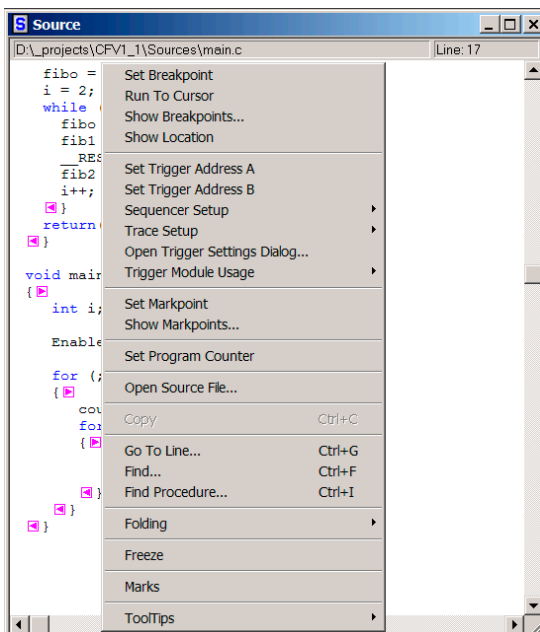

Trigger Module Settings Window

This window can be opened from context sensitive context menus in the Source, Data, Memory and Assembly component windows, from the Connection menu and also when clicking on a Status Bar displayed mode (Automatic, by default).

The on-chip DBG module can be fully controlled from within this window.

The dialog is designed with three tabs. Trigger Settings is the main tab, where all modes of the debugger can be selected in the top drop down box.

Figure 31.2 Trigger Module Settings Window - Trigger Settings Tab

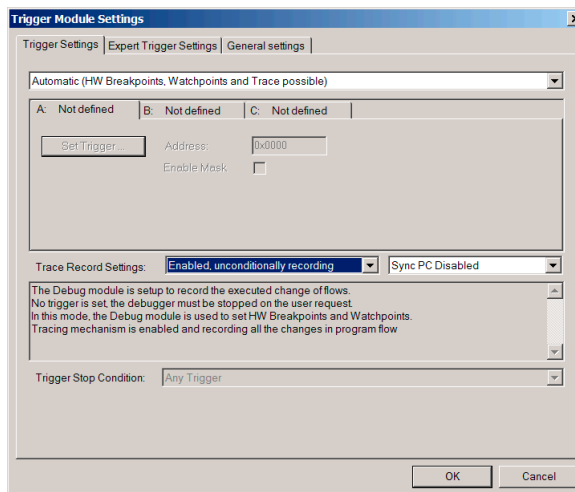

Trigger Module Usage/DBG Module Setup

In the Trigger Settings main tab, three modes can be selected to take advantage of the on-chip DBG module:

- An **Automatic** mode, which does not provide trigger functionalities, therefore, does not provide complex breakpoints or complex watchpoints, but typically, four hardware breakpoints and one watchpoints that can be set as usually via windows context sensitive context menus or command line commands.
- An **Expert** mode, which is a “Do It Yourself” interface to set the on-chip DBG module. In that case, the debugger does not use any on-chip module resources. Refer to silicon specifications to correctly set up the DBG module. The debugger still provides the Trace rebuild window and support to display, when available, the results of the captured data.

ColdFire On-Chip DBG Module

Trigger Module Settings Window

- A **User Triggers** mode, which provides two complex breakpoints, triggers A and B, one complex watchpoint, trigger C, and two spares classic hardware breakpoints that can bet as usual (not in the dialog).
- A **Profile and Coverage** mode, which provides code profiling and coverage information when opening the Profiler and Coverage components. Note that these features are not real time. The debugger can only access the DBG on-chip trace buffer/FIFO when the device is halted. Therefore, in background, the debugger regularly halts the device, retrieves debug information, then restarts the device, to build a statistic program counter database. Refer to [Profiling and Coverage Mode](#).

Figure 31.3 General Usage Listbox

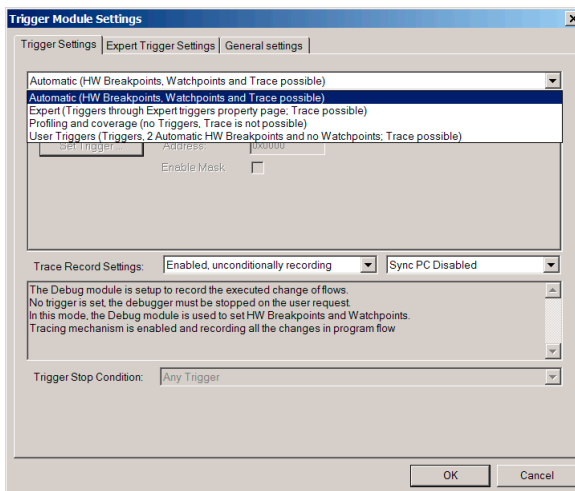

Automatic Mode

Automatic provides only two behaviors for the Trace window in the **Trace Settings** list menu:

- Disabled: not recording any data and not displaying anything in the Trace window,
- Enabled: recording continuously. Each time the debugger is halted, the Trace window is refreshed with the latest program flow recorded.

Figure 31.4 Trace Settings for Automatic mode

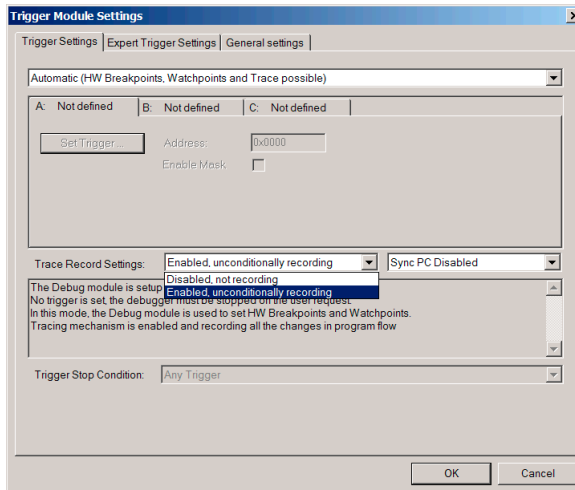

Sync PC DBG Feature

The Sync PC DBG feature forces the DBG module to capture the current program counter at regular intervals and record this PC in the on-chip DBG buffer/FIFO. This is disabled by default but is extremely useful when debugging program code loops without changes of flow. When code loops are executed without traceable information, the DBG module does not record any data, and the debugger cannot rebuild any program flow in the Trace window.

To force the DBG module to capture program flow information regardless of the executed instructions, engage the Sync PC feature using the list menu. The more cycles in the loop you are debugging, the higher you can set the Sync PC cycle.

Figure 31.5 Sync PC List Menu

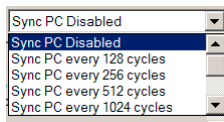

NOTE Engaging the Sync PC feature forces the on-chip DBG module to fill its capture buffer/FIFO with data that is usually not necessary. Using this feature automatically reduces the amount of change of flow information in the DBG buffer/FIFO, and restricts program flow rebuild code range in the Trace window.

User Triggers mode

When choosing the **User Triggers** mode, the full strength of the on-chip DBG module can be exploited in the debugger, providing emulator functionalities.

The **A**, **B** and **C** tabs become accessible to give exact triggering information. Triggers **A** and **B** hardware breakpoints can be set using the **Set Trigger** button. Refer to [HCS08 On-Chip DBG Module](#) for information about the **Browse for Trigger** interface.

TIP Trigger A (only) can be adjusted with a mask on the address, that can be set in the *Mask* field when the *Enable Mask* checkbox is set.

The *Trace Settings* list menu gives a set of options to choose the way the module is going to start and to stop recording.

Figure 31.6 Trace Settings for User Triggers mode

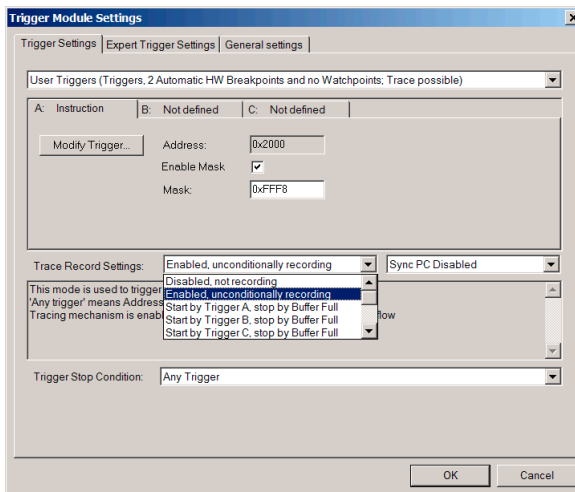

The *Trigger Stop Condition* list menu allows you to specify basic sequences and triggers to pass to break the debugger.

Figure 31.7 Trigger Stop Condition sequencer

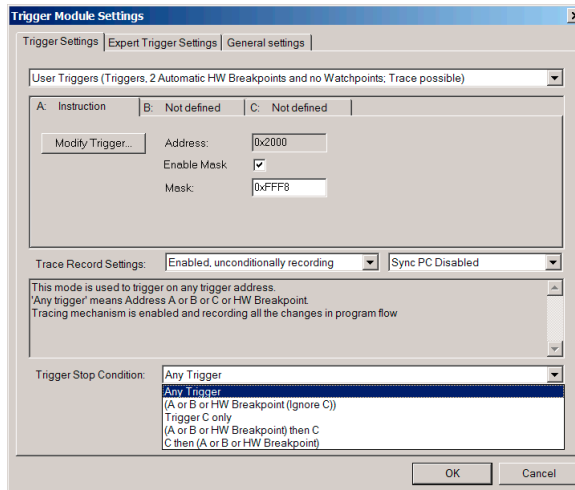

The trigger C provides specific data access options. When setting the *Enable Data Compare* edit box, additional fields are accessible to specify the data to compare, the mask, and the bus information to check for compare in the *Compare Mode* list menu.

The watchpoint size can be edited within the **Set Trigger/Browse for Trigger** interface.

Figure 31.8 Trigger C advanced data access/watchpoint

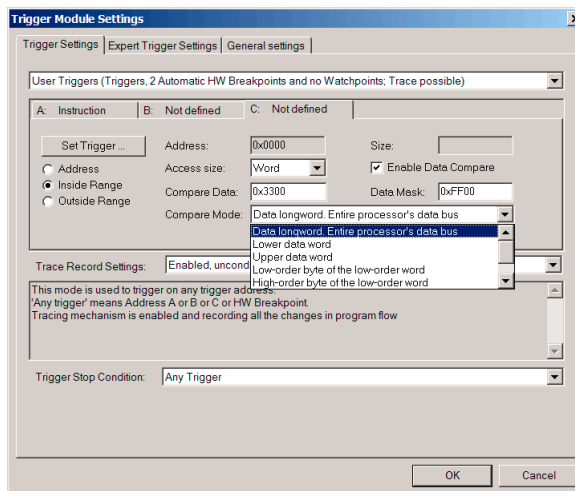

Expert Mode

The Expert mode is a “Do It Yourself” interface to set the on-chip DBG module. In that case, the debugger does not use any on-chip module resources. Refer to silicon specifications to correctly set up the DBG module. The debugger still provides the Trace rebuild window and support to display, when available, the results of the captured data.

Enhanced setup

The **ABxR (hex)** edit box setup combines **ABHR** and **ABLR** registers setup.

Set the CSR2 register using the *Mode* and *Start/Stop* list menu, or by using the *Select* button.

Figure 31.9 Expert Trigger Settings: CSR2 interactive translation of recording mode

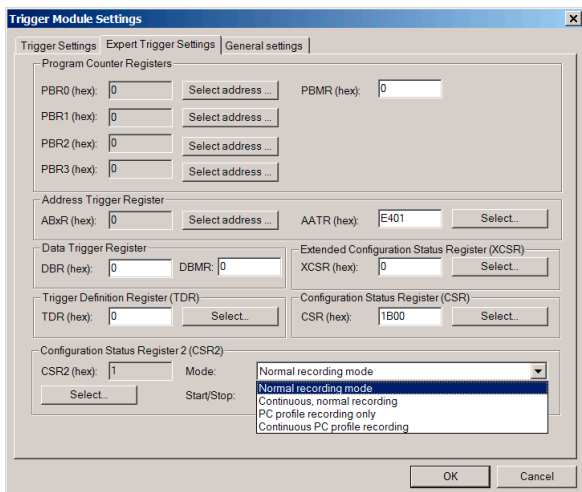

Setting CSR2 by using the *Select* button automatically updates the *Mode* and *Start/Stop* list menu selection, and vice versa.

Figure 31.10 Expert Trigger Settings: CSR2 interactive translation of start/stop condition

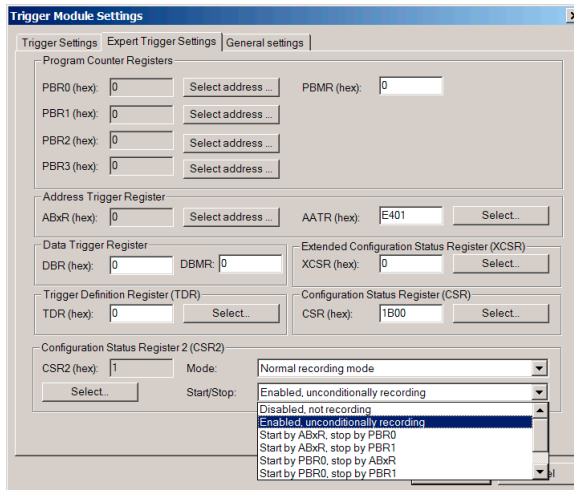

General Settings

Automatically analyze the FIFO content: When the debugger halts for any reason with the Trace window open, the DBG module results are automatically analyzed and displayed in the Trace window. If the Trace window is closed, the DBG user interface performs no result analysis except trigger flags reported in the status bar. Clearing this check box restricts result analysis even with the Trace window open.

When starting, automatically step if a trigger is set at PC address (otherwise: warn): To run the application again, the debugger usually needs to exit the trigger current match condition and avoid being stuck/halted/locked by the trigger. This usually requires a single step to “escape” from a hardware breakpoint.

Issue warning on attempt to execute with incorrect Sequencer settings: When the on-chip DBG module sequencer is set up incorrectly, the debugger displays an informative error message when started.

Figure 31.11 Sequencer Error Message

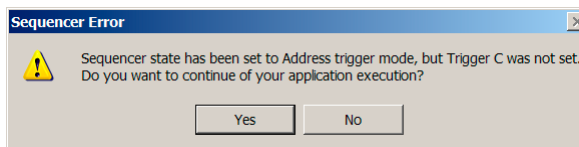

ColdFire On-Chip DBG Module

Trigger Module Settings Window

Figure 31.12 General Settings tab

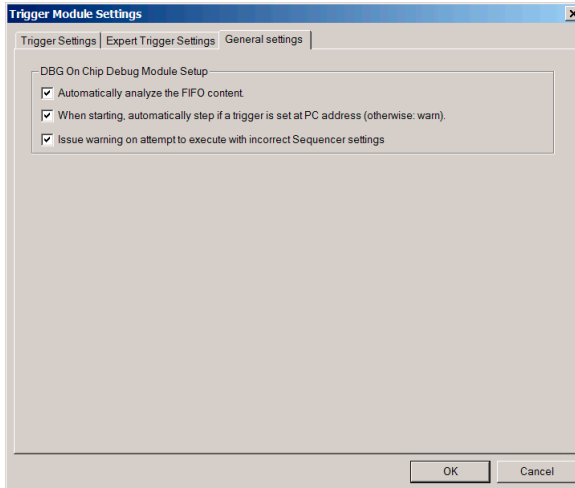

Book VI - Connection Common Features

Book VI Contents

Each section of the Debugger manual includes information to help you become more familiar with the Debugger, to use all its functions and help you understand how to use the environment.

Book 6 is divided into the following chapters:

- [Flash Programming](#)
- [Debugging Memory Map](#)



Book VI Contents

Flash Programming

Non-Volatile Memory Control Utility Introduction

Writing to Flash modules, EEPROMs, or other non-volatile memory modules in modern MCUs requires special algorithms from microprocessor designers. Before you write to Flash devices, you must erase them. Many Flash devices need initialization to become accessible; some devices may need write protection removed.

This manual explains the Non-Volatile Memory Control (NVMC) utility, an extension component that lets you control on-chip Flash devices for all debugger connections.

As it supports many MCUs and Flash modules, the NVMC utility is very flexible. This flexibility comes from a generic debugger component, which calls a graphical user interface, then loads an MCU-specific module. The module provides the appropriate information such as structure, access algorithms, and location for that MCU.

The NVMC utility lists all non-volatile memory devices, indicating their structure, state, and location. You can change the state (enabled/disabled, blank, programmed, protected/unprotected) and program data into the modules.

Automated Application Programming

The debugger is able to program an application without making use of the NVMC dialog box/GUI, which remains useful for specific operations only. Currently, CodeWarrior IDE projects created from a series of wizard dialog boxes might be programmed/Flashed immediately. By default, the debugger prompts a warning dialog box to get user acceptance before mass erasing, then programming the application.

Use the FLASH-specific command (`FLASH NOUNSECURE`) described in this chapter to incorporate device security byte programming in user code.

Flash Programming

Automated Application Programming

Figure 32.1 Flash Programming Acceptance Dialog Box

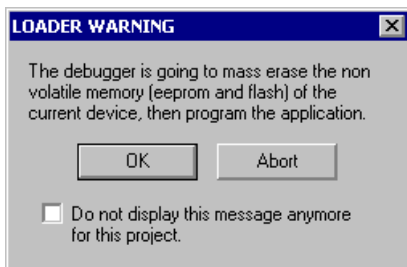

Select the *OK* button to launch background Flash commands. These commands arm programming, load/program an application file, then disarm programming, and are described later in this chapter.

Check the **Do not display this message anymore for this project** checkbox to remove the Warning message for the current project. The setting is saved in the project under the project variable: `AEFWarningdialog_box=FALSE`.

Setup

Choose the *Load* menu entry in the connection debugger menu (for example, HCS08 Open Source BDM) to open the Load Executable File dialog box.

Figure 32.2 Load Executable File Dialog Box option

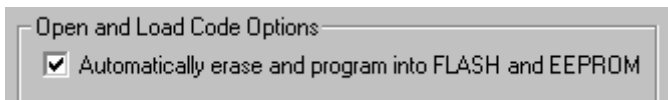

Check the above option to automatically mass erase the device and program the application into non-volatile memory (FLASH and/or EEPROM).

To permanently set this option, a check box is available in the Load tab of the debugger Preferences dialog box, as shown in [Figure 32.3](#). Select the *File > Configuration* menu command to display this dialog box.

Figure 32.3 Load Preferences

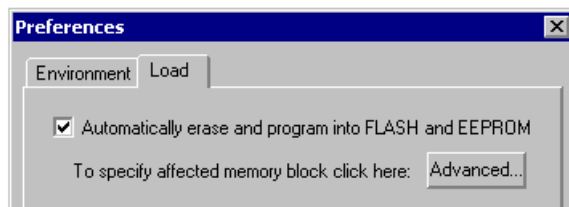

Advanced Options: Erase Prevention

Select the *Advanced* button in the Load tab of the debugger Preferences dialog box to open the following selection dialog box.

Figure 32.4 Programming Selection

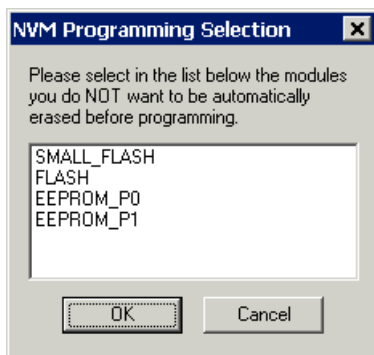

The dialog box lists all the non-volatile memory modules registered by the debugger for the currently selected processor device.

Click once on a line to select an item (highlighted in blue) and click again on a selected item to deselect it.

Erasing is skipped for all selected modules. If you select all modules, the debugger programs the application without erasing any non-volatile memory on the device.

CAUTION The debugger ignores pre-programmed modules and the user is responsible for reprogramming limitations, risks and impossibilities. However, the debugger displays a warning message when a programmed (i.e. not blank) “not automatically erased” module is going to be written. You can disable the displayed warning message.

TIP When available on-chip, EEPROM type modules are by default **not** selected for automatic erasing.

The selection dialog box does not give many details about the listed blocks. More information can be displayed by typing the `FLASH` command in the Command window, or by opening the Non-Volatile Memory Control dialog box.

The NVM Programming Selection dialog box is tightly associated with the `FLASH AEFSKIPERASING` command of the debugger.

NVMC Graphical User Interface

The NVMC utility is integrated into the debugger as an extension of certain debugger connections. If the NVMC utility is available, your connection menu includes a **Flash** selection.

Figure 32.5 HCS08 Open Source BDM Connection Menu Example

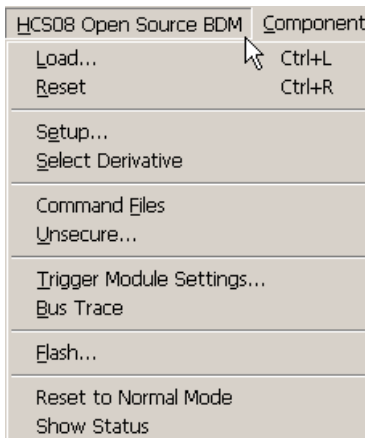

Modules and Module States

In the following sections, the expression *available modules* means all the FLASH or EEPROM on-chip modules that the NVMC dialog box lists. The module definitions correspond with the CPU derivative technical summary and special technical considerations. If an on-chip module consists of several independent blocks, the NVMC dialog box might list all of these blocks. However, typically groups the entire non-volatile on-chip blocks under one single listed module and separates relevant and important non-volatile memory blocks (such as mirrored non-banked memory range), and provides an individual/selective module for these.

NOTE Refer to [Hardware Considerations](#) for more information about the Flash modules of your CPU derivative.

Other important expressions are:

- **Enabled** — An *enabled module* is a module currently active on the chip. It is possible to read (as a ROM) or program an enabled module.

-
- **Disabled** — A *disabled module* is not active on the chip, so programming and reading are not possible. The usual control for enabling or disabling a module is setting/clearing a flag in a special register. Note that a few modules always must be active. You may not disable such modules.
 - **Blank** — A *blank module* is empty of code: you can program its full address range. (Each blank byte contains the value 0xFF or 0x00, depending on hardware.)
 - **Programmed** — A *programmed module* is partially programmed (not all bytes contain 0xFF or 0x00). You must keep track of the areas still available for programming, if any.
 - **Protected** — A *protected module* is partially protected from erasure or programming. The usual control for protecting a module is setting/clearing a flag in a special register. Note that a few modules always must be unprotected; you may not protect such modules.
 - **Unprotected** — An *unprotected module* can be erased and programmed.

To select a module or other list item, left-click the module. To deselect a module, press the Ctrl key and left-click. For multiple selections or deselections, use the Shift key.

NVMC Dialog Box

The NVMC dialog box lists all the Flash or EEPROM modules of a CPU derivative. A derivative such as the MC9S08RC16 or the MCF51QE128 has just one on-chip Flash module; other derivatives have multiple modules.

NOTE The dialog box does not have a Select or Deselect button, since you simply click on a module in the list to select it. But selecting and deselecting are not automatic from the command line. Before you use the command line to perform any operation on a module, you must use the `SELECT` command to select the module. Also see the `FLASH SELECT` and `FLASH UNSELECT` commands in this chapter.

Flash Programming

NVMC Graphical User Interface

Figure 32.6 Non-Volatile Memory Control Dialog Box

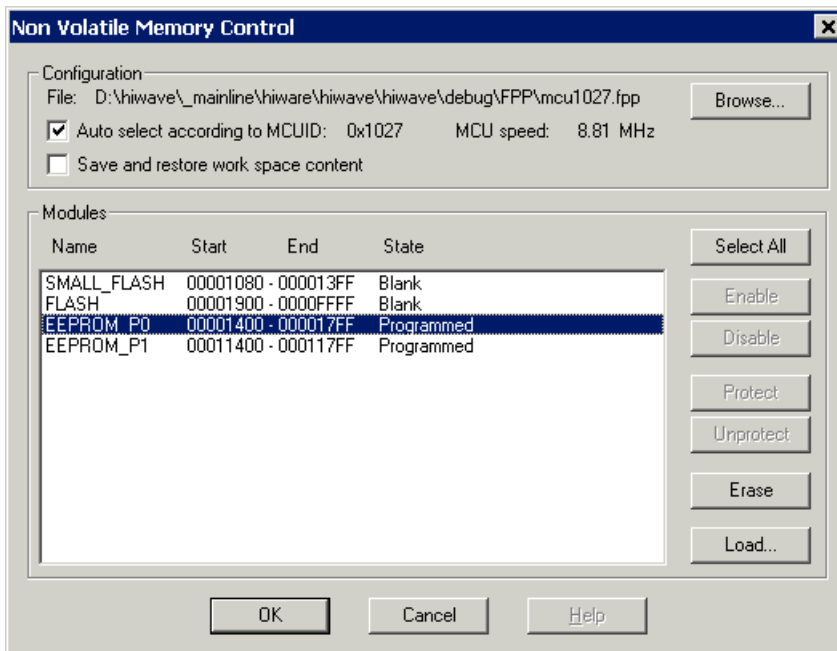

For each block, the dialog box has a line composed of the following fields:

- **Name** — the module name
- **Start** — the module start address
- **End** — the module end address
- **State** — the modules states, such as *disabled*, *enabled*, *blank*, *programmed*, *protected*, *unprotected*

Possible state combinations are:

- **Bad Device** (the interface was unable to detect a correct device)
- **Disabled** (one or all modules are disabled)
- [Enabled] / <Blank | Programmed> / [Unprotected | Protected]

The NVMC dialog box displays only meaningful states. For example, it displays *Enabled* only if it is possible to *disable* a module. It displays *Unprotected* only if it is possible to *protect* a module.

The Configuration group identifies the current .FPP parameter file. This group also includes the **Auto select according to MCUID** checkbox. The **Configuration: FPP loading** section explains this option.

The second checkbox of the Configuration group is **Save and restore workspace content**. If this checkbox is clear, Flash programming applications overwrite any data in RAM. Check this box to save the current RAM data. Saving RAM data slows down the NVMC. Checking this checkbox is equivalent to entering the `SAVECONTEXT` and `LOADCONTEXT` commands.

Flash Module Handling

Flash parameter files (which have the extension `.FPP`) contain MCU-specific parameters, as well as programs to handle internal Flash modules. The *FPP Files* section includes additional information about `.FPP` files. The `.FPP` files also include code-applet descriptions of Flash operations.

You also may use the Command Line component to handle Flash operations. The *NVMC Commands* section explains the corresponding commands.

The NVMC dialog box has buttons for commands you can apply to each block. These buttons are dynamic; active if the operation is possible for at least one selected item, disabled if the operation is not possible.

- Select All/Unselect All — The **Select All** button selects all modules in the list box. After the button is pressed, the button changes to **Unselect All**, and can be pressed to remove all current selections.
- Enable/Disable — The **Enable** button enables all selected modules currently disabled. The **Disable** button disables all selected modules currently enabled. The possibility of enabling or disabling a Flash module depends on the MCU features and context.
- Protect/Unprotect — The **Protect** button protects all selected modules currently unprotected. The **Unprotect** button unprotects all selected modules currently protected. The possibility of protecting or unprotecting a Flash module depends on the MCU features and context.

NOTE For some MCUs, protection is possible only for the Boot section and boot routines, not for the entire module. Refer to [Hardware Considerations](#) for protection information about your CPU derivative.

- Erase — The **Erase** button removes any programming from all selected Flash modules. That is, it assigns the value `0xFF` or `0x00` to each byte. Erasure changes the module status to Blank. If all the selected modules already are blank, the Erase button is disabled.
- Load — The **Load** button arms all selected modules, executes a `LOAD` command, then disarms the modules. If you click the **Load** button without selecting any Flash modules, the NVMC utility selects and loads all modules.

NOTE You simply click on a module in the list to select and/or use **Select All/Unselect All** buttons to adjust your selection. But selecting and unselecting are not automatic from the command line. Before you use the command line to perform any operation on a module, you must use the `SELECT` command to select the module. Also see the `FLASH SELECT` and `FLASH UNSELECT` commands in this chapter.

MCU Speed Information

The displayed MCU speed is the device bus speed/clock sensed by the Flash programmer; same value as the one returned by the `FLASH` command.

CAUTION A non-relevant displayed speed is symptomatic of a Flash programmer diagnostic problem. If this occurs, close the dialog box, check the hardware, and reset the connection.

Configuration: FPP File Loading

When the dialog box is open, the NVMC utility loads the `.FPP` configuration file according to this algorithm:

1. The utility reads the `NV_PARAMETER_FILE` entry from the connection-specific section of the `project.ini` file. [`HCS08 Open Source BDM`] is a connection-specific section.

Example:

```
[HCS08 Open Source BDM]
```

```
NV_PARAMETER_FILE=C:\MYINSTALL\PROG\FPP\mcu1027.fpp
```

2. If the utility retrieves a valid `.FPP` file name, it loads the file.
3. If the utility cannot find a valid `.FPP` file name, it displays an appropriate error message.
4. If the utility does not find an entry, or if it finds an empty entry, the utility automatically checks the **Auto select according to MCUID**: checkbox. Then the utility loads the parameter file from the `\FPP` subdirectory of the CodeWarrior IDE installation, according to the MCUID.
5. If the utility finds a file that has the wrong format, it displays an appropriate error message.
6. The utility always displays the MCUID, if the Id is available from the connection.

Another way to load an .FPP parameter file is by clicking the **Browse** button. This brings up a standard **Open** dialog box, which you can use to select the file. When you do so, the **Open** dialog box disappears, and the NVMC utility loads the file, automatically clearing the **Auto select according to MCUID:** checkbox. In case of an error during loading, the utility displays an appropriate message.

Figure 32.7 Open Dialog Box

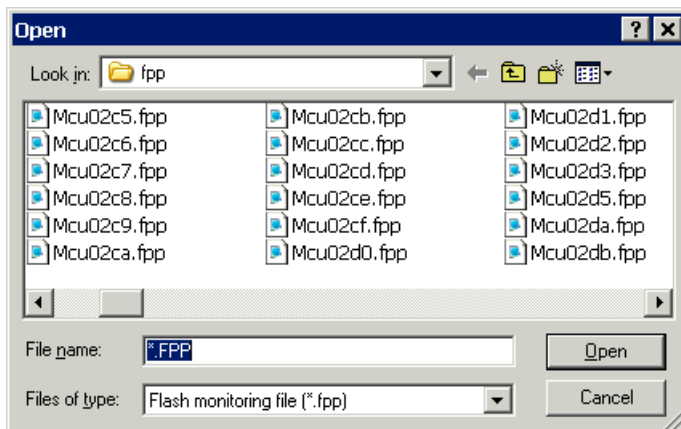

If you check the **Auto select according to MCUID:** checkbox, the NVMC utility searches for and loads the corresponding .FPP parameter file.

Click the **OK** button to close the NVMC dialog box. If the **Auto select according to MCUID:** checkbox is clear, the NVMC utility saves the name of the selected configuration file under the `NV_PARAMETER_FILE` entry of the `project.ini` file. If you check this checkbox, the utility does not save the .FPP in the project file.

Click the **Cancel** button to close the dialog box without saving changes.

Loading an Application in Flash

The **Load** button and the **Load** menu selection perform the same function. Use either of these controls to bring up the Load Executable File dialog box, which lets you select the file to be loaded. The Load Executable File dialog box lists the executable files that relate to blocks selected in the NVMC dialog box.

Figure 32.8 Load Executable File Dialog Box

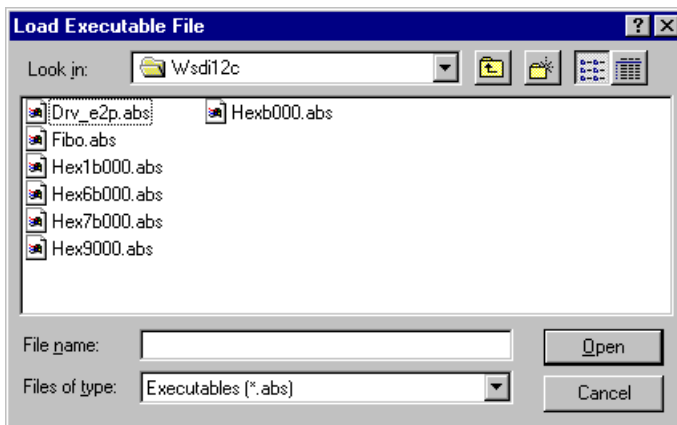

If a problem occurs during application loading into Flash, the NVMC utility displays an error message.

Figure 32.9 FLASH Writing Error Message Box



This means that you tried to load a program into an unselected section. The NVMC utility's selecting/unselecting feature reduces the risk of overwriting, erasing, or unprotecting valuable data.

Hardware Considerations

This section consists of hardware-specific information about current .FPP files. New .FPP file features are explained in release notes.

NOTE The Flash programming release note, in the toolkit installation documentation, contains the latest information about .FPP files.

HCS08 CPU devices

Typically, one or two Flash modules are listed: FLASH and SMALL_FLASH. SMALL_FLASH is usually a small block of Flash located below the “High Page Registers” range. As this range of FLASH is physically linked to the rest of the FLASH, erasing this block also affects the Flash module, and vice versa. FLASH is the main block of FLASH above the “High Page Registers” range.

HCS08 CPU devices with banked/paged EEPROM

As devices described in previous section, FLASH and SMALL_FLASH might be available.

EEPROM_P0 and EEPROM_P1 are provided to program directly paged EEPROM ranges. Note that when programming banked/paged EEPROM ranges, programming addresses must be considered ‘logical’. Erasing one module also erases the other mode.

The setup of EPGMOD bit of FOPT register is **not** handled.

TIP When available on-chip, EEPROM type modules are by default **not** selected for automatic erasing. Refer to [Advanced Options: Erase Prevention](#) section.

ColdFire CPU devices

WARNING! Programming ColdFire devices via the NVMC dialog requires proper device initialization. Otherwise the device speed sensing fails and programming/erasing cannot be performed correctly. Typically, program the ColdFire Flash with the Load Executable File dialog box.

NVMC Commands

The following Flash commands can be issued through the debugger Command component window, as shown in the figure below.

Figure 32.10 NVMC Commands In Command Window

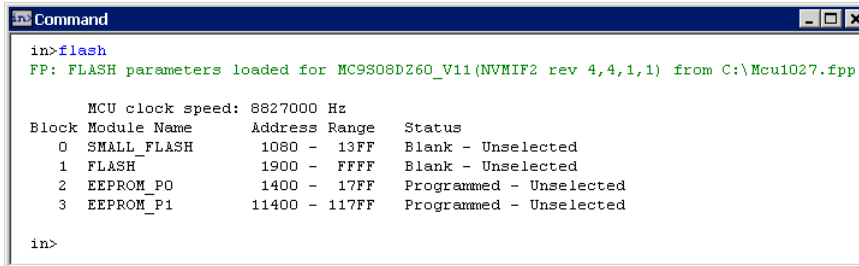

```

in>flash
FP: FLASH parameters loaded for MC9S08D260_V11(NVMIF2 rev 4,4,1,1) from C:\Mcu1027.fpp

      MCU clock speed: 8827000 Hz
Block Module Name      Address Range      Status
  0  SMALL_FLASH      1080 - 13FF      Blank - Unselected
  1  FLASH             1900 - FFFF      Blank - Unselected
  2  EEPROM_PO        1400 - 17FF      Programmed - Unselected
  3  EEPROM_P1        11400 - 117FF    Programmed - Unselected

in>

```

FLASH

Short Description

Displays Flash modules, loads . fpp file, or performs Flash operations.

Syntax

```

FLASH [ (SELECT | UNSELECT | ERASE | ENABLE | DISABLE | PROTECT |
        UNPROTECT | AEFSKIPERASING) [<blockNo>] ]
| [ARM | DISARM | SAVECONTEXT | LOADCONTEXT | MEMMAP | MEMUNMAP | RELEASE
   | OVLBACKUP | OVLRESTORE | PROTOCOLON | PROTOCOLOFF | SKIPSTATUS
   ON | SKIPSTATUSOFF | NOUNSECURE | UNSECURE]
| [NVMFREQUENCY <frequency in Hz>]
| [NVMIF2RELOCATE <address>]
| [NVMIF2WORKSPACE <address> <address>]
| [INIT <fileName> | AUTOID]

```

Description

The FLASH command displays names, locations, and states of all available modules; provided that a parameter (. fpp) file is already loaded. If no parameter file is loaded, this command loads either the . fpp file for the current MCUID or the last-used . fpp file.

FLASH INIT <fileName> | AUTOID loads the parameter file according to fileName (you can specify the path). If this command includes AUTOID, the MCUID determines the parameter file (**autocheck** is checked in the NVMC dialog box).

FLASH RELEASE releases the current FPP file loaded by the Flash programmer. Therefore the Flash programmer address mapping is disabled and no non-volatile memory is handled.

FLASH MEMMAP maps the Flash programmer address filtering to route the code for block programming.

FLASH MEMUNMAP unmaps the Flash programmer address filtering. Programming is therefore disabled as long as FLASH MEMMAP is not executed.

FLASH ENABLE enables the specified modules. If no modules are specified, all available blocks are enabled. This command ignores modules that cannot be enabled.

FLASH DISABLE disables the specified modules. If no modules are specified, all available blocks are disabled. This command ignores modules that cannot be disabled.

FLASH ERASE erases the specified modules. If no modules are specified, all available blocks are erased.

FLASH AEFSKIPERASING specifies non-volatile memory blocks to protect from mass erasing during application automated programming. Place the command in a **Startup** command file. If no modules are specified, no blocks are erased.

NOTE This command is compatible and replicated in the NVM Programming Selection dialog box.

FLASH UNPROTECT unprotects the specified modules. If no modules are specified, all available blocks are unprotected. This command ignores modules that cannot be unprotected.

FLASH PROTECT protects the specified modules. If no modules are specified, all available blocks are protected. This command ignores modules that cannot be protected.

FLASH SELECT selects the specified modules for Flash programming. If no modules are specified, all available blocks for Flash programming are selected.

FLASH UNSELECT deselects the specified modules. If no modules are specified, all available blocks are unselected. The unselected state protects against accidental Flash programming.

FLASH ARM prepares the NVMC utility for loading; as does a normal LOAD command. The system executes the VPPON .CMD file specified in the Command Files user interface. This command is required before loading FLASH.

FLASH DISARM ends a load process. The system executes the VPPOFF .CMD file specified in the Command Files user interface.

FLASH SAVECONTEX backs up current SRAM content into a buffer.

Flash Programming

NVMC Commands

FLASH LOADCONTEX restores current buffer content into the MCU SRAM.

FLASH OVLBACKUP backups application code overlap with programming runtime/algorithm (RAM preset for debugging). Execute the command before loading the application/file.

FLASH OVLRESTORE restores/installs (writes in RAM) the application code overlap with programming runtime/algorithm. Execute the command after the last FLASH command.

FLASH PROTOCOLON displays the Flash programmer debug protocol.

FLASH PROTOCOLOFF stops displaying the Flash programmer debug protocol.

FLASH SKIPSTATUSON skips the Flash programmer device Non-Volatile Memory blocks diagnostic. You can use this command to speed up project application loading and programming from the IDE debug run. The Flash programmer does NOT verify that blocks are programmed or erased.

FLASH SKIPSTATUSOFF removes the SKIPSTATUSON mode and therefore diagnostics are performed again.

FLASH NVMFREQUENCY <frequency in Hz> specifies the Non-Volatile Memory programming frequency in Hertz; typically the device bus speed after reset. When used, the Flash programmer does not try to evaluate this speed and the debugger gains 2-3 seconds at application loading time. A value of “0” enables the speed detection.

FLASH NVMIF2RELOCATE Command not relevant for HCS08 devices.

FLASH NVMIF2WORKSPACE Command not relevant for HCS08 devices.

FLASH UNSECURE After device mass erasing, the Flash programmer automatically programs the device security byte to the “Unsecure” state to enable code debugging (default behavior).

FLASH NOUNSECURE After device mass erasing, the Flash programmer does not program the device security byte to the “Unsecured” state. The command must be placed in a **Startup command file**, to be executed before any erase operation.

TIP Use this command when the user application contains the code to program the device security byte. This guarantees that no over-programming is performed on the Flash security byte cell.

CAUTION If the device security byte is not programmed to the “Unsecured” state, after the device is reset, debugging is no longer possible until the next mass erase and security byte is programmed to “Unsecured” state.

[<blockNo>]

blockNo is a list of Flash block/module numbers, according to this syntax:

blockNo = {number ["-" number] [" , "] }

Examples

```
FLASH ERASE 2,7
```

This erases memory blocks 2 and 7.

```
FLASH ERASE 2,4-6 8
```

This erases memory blocks 2, 4, 5, 6, and 8.

```
FLASH ERASE
```

This erases all available memory blocks.

While Flash modules are armed, execution of user code is not possible. If you enter a command such as **run**, **step**, or so forth, a message box prompts you to disarm the modules or cancel the command. If you click the **OK** button, the system disarms all Flash modules, then executes your command. If you click the **CANCEL** button, the system cancels the command and leaves the Flash modules armed.



Flash Programming

NVMC Commands

Debugging Memory Map

Introduction

The Debugging Memory Map (DMM) is a software Manager handling all debugger accesses to device/chip memory and also handling memory data caching.

The DMM provides a global approach for all different CPU families/cores, each family having its own method for memory access and its own memory on-chip layout and memory address range priorities.

The DMM gets all memory read and write calls from the debugger. On the other side, the DMM has the very low level function read/write primitives to call third party cable drivers of BDM pods, Monitors, etc.

For each CPU core, the debugger provides the DMM with core-specific read/write access methods that are called *Types* within the DMM Graphical User Interface (GUI), and core-specific priority rules that are called *Priority* within the DMM GUI.

Indeed, the DMM has a GUI, therefore providing to the user a way to change memory access methods at any time.

The DMM GUI

The graphical user interface is flexible enough to be handled without much difficulty, and live diagnostic is displayed within the dialog. Anytime, it is possible to revert to default (factory) setup, and most of the time, the user does not even need to edit/change settings within the DMM GUI.

The DMM GUI can be opened when choosing **Debugging Memory Map** in the connection menu entry in the debugger.

Debugging Memory Map

The DMM GUI

Figure 33.1 DMM Graphical User Interface

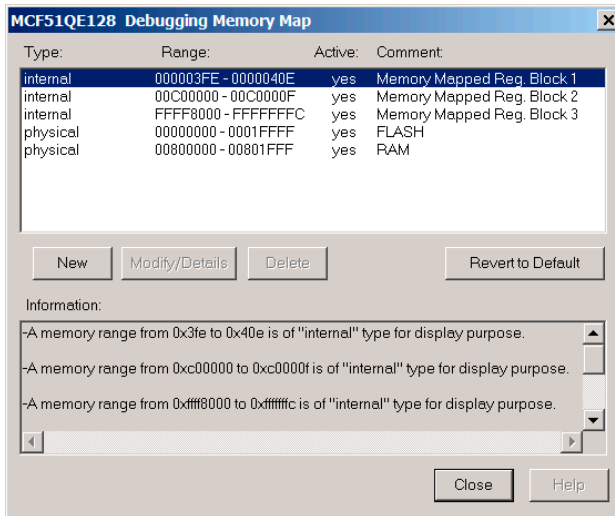

The DMM GUI shows a list of memory address ranges (called *Modules* in this manual) defined to access the device/chip memory.

The **Type** column tells the type of memory for the defined memory address range given in the **Range** column. The **Active** column indicates whether the defined range is active or mapped by the DMM. If **No**, the DMM treats the range as if it is not defined at all.

NOTE All undefined ranges are considered by the DMM as inaccessible or unimplemented. The debugger displays some "--" in the Memory window in that case, and the DMM NEVER attempts to read or write unimplemented memory.

The **Comment** column contains a text information comment about the defined memory address range.

The **Information** scrollable window gives a general diagnostic of the DMM: This diagnostic has less information than the edition mode diagnostic.

Pressing the **New** button opens the edition dialog to create a new memory address range.

Pressing the **Modify/Details** button opens the edition dialog of the selected memory address range to modify it or to see more setup details. More memory range information is displayed in the edition dialog, and an enhanced diagnostic is also displayed.

Pressing the **Delete** button removes the memory range, after a warning dialog.

Pressing the **Revert to Default** button removes (after a warning dialog) the current setup (usually saved in the current project) and retrieves the default (factory) setup from an internal database.

Edition dialog and memory range edition

[Figure 33.2](#) shows the DMM Memory map dialog box.

Figure 33.2 DMM Memory Address Range Edition Dialog box

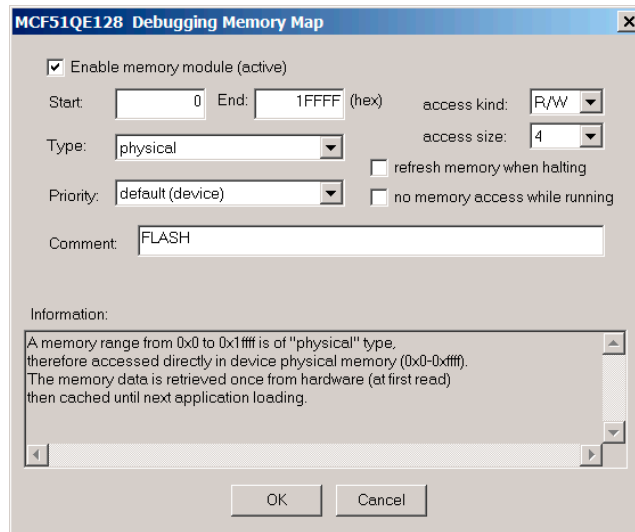

The **Enable memory module** option checkbox maps the module/memory range in the debugger. Unchecking this option makes the module completely transparent for the DMM and the debugger.

The **Start** edit box contains the first address of a memory range and the **End** edit box contains the last address of a memory range.

Range boundaries are always limited to an overlapped range with a bigger priority.

For example, if 2 bytes are defined in a range which overlaps another range, accessing these 2 bytes is performed using the type and rules of this 2-byte range. The memory on both sides of these 2 bytes is accessed using the type and rules of the overlapped range.

NOTE The **Start–End** range is a range address for a **Type** and for a **Priority**. Internally, ranges can overlap only if they are of the same type and of the same priority. The debugger always reads with rules of the range with the highest priority.

Access kind

The **Access Kind** list menu provides a way to indicate that the memory range is read/write (R/W), read only, write only or none of these.

When defined as read only, the range is never written by the debugger.

When defined as write only, the range is never read by the debugger.

When defined as none, the range is never read or written by the debugger. This is internal equivalent as not defining the range in the DMM dialog.

Access Size

When available, the **Access Size** list menu provides a way to define if the memory range is accessed as byte (1), short (2) or long (4).

NOTE The memory range must be size aligned. For example, a module defined with access size **2** must start with an even address and finish on an odd address. A module defined with access size **4** must start with an address with the least significant byte in 0, 4, 8, C, and finish with an address with the least significant byte in 3, 7, B, F.

NOTE A memory range overlapping (in priority) another memory range can only have the same or a higher access size.

Types

The **Type** list menu provides all kinds of memory types available for the processor displayed in the title bar of the dialog. For some connections, the CPU core might be displayed instead of the processor name.

Types are internal rules to read and write a kind of memory. For examples, the HCS08 banked type requires first setting a register called PPAGE to read the memory, then restoring this value as it was before reading. Also this banked type does not physically provide a memory access while running. Memory access while running is possible in physical memory (RAM, registers).

Figure 33.3 DMM Type selection

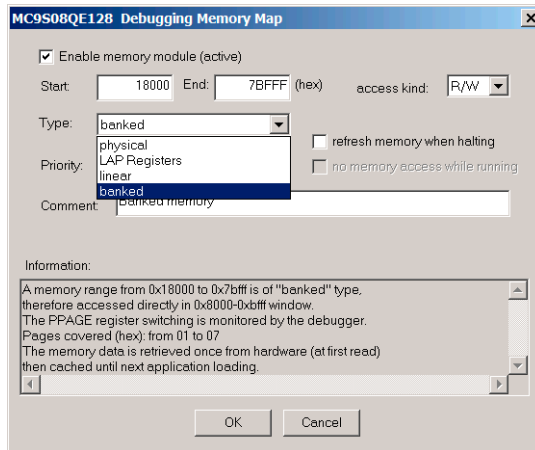

NOTE CPU core-specific memory types and Priorities are listed at the end of this section.

Priorities

The **Priority** list menu provides all types of memory overlap priorities available for a processor core. The debugger can have a bigger priority (highest (debugger)) to set an upper address range that can overlap an on-chip address range. This makes a debugger display filter (for a Memory window), e.g. when creating a **No read access while running memory** address range.

A **Flat** memory architecture (i.e., without memory blocks moving feature) provides the following Priority list menu (e.g. HCS08 and ColdFire cores):

Figure 33.4 HCS08 or ColdFire Core Priorities

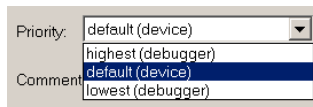

When left at the default setting, the CPU treats all memory block with the same priority.

Memory Read Caching

The **Refresh memory when halting** option controls the debugger memory cache. When this option is checked, internal images/caches of memory data are always deleted and the data is always retrieved from hardware when required by the debugger. When unchecked (usually by default for Non-Volatile Memory areas), the DMM keeps a copy of the data and does not read or retrieve the data from hardware until next application loading/programming.

NOTE Each declared memory address range in the GUI has its own private code cache monitored by the DMM.

TIP The DMM `CACHINGOFF` command can fully disable the caching feature for the entire DMM, that is, for all defined memory ranges. The DMM `CACHINGON` command re-enables the caching feature.

Access while Running

Use the **No memory access while running** option to discard debugger access to a memory range, typically accessed while running. This feature is useful to protect on-chip I/O Register flags from being triggered by debugger memory reads due to display refreshes.

Remarks

It is possible to create as many memory ranges as wanted, down to a single byte.

Deleting Default/Factory ranges generates warning dialogs. Some settings are required for the debugger to debug and removing ranges leads to erroneous debugging information.

All GUI settings can be done by debugger commands.

Settings and DMM changes are saved in the current user project. The user can always restart from draft pressing the **Revert to Default** button.

Automatic DMM range remapping can be disabled by a debugger command.

The default settings are retrieved from a complete database describing each derivative, or, in some cases, describing the CPU core (when not necessary to go to derivative level).

CPU Core Types and Priorities

This section details the available cores and their respective types and priorities.

HCS08 CPU

The following types and priorities are available for the HCS08 CPU.

Priorities:

- **highest (debugger):** a high debugger priority that can be used by the user or defined for the debugger, typically to protect a memory area from being read.
- **default (device):** default CPU visibility of the entire device/memory with the same priority, so no memory range can be moved to overlap another memory range.
- **lowest (debugger):** a low debugger priority that can be used by the user or defined for the debugger typically to protect a memory area from being read. This priority is of poor usage but can still be used for display purposes on chip unimplemented memory range.

Types:

- **LAP Registers:** This mode is only available for HCS08 devices with an on-chip MMU. This sets the memory range as special on-chip LAP registers. Typically, a specific range is already preset with this type so you do not need to use this type.
- **linear:** This mode is only available for HCS08 devices with an on-chip MMU. This sets the memory as **linear address space** (also called **Extended Address**); range typically addressed by the on-chip linear address pointer.
- **physical:** this sets the memory range as physical, i.e. with **local 16-bit address bus access as performed by the CPU when reading and writing the on-chip memory**.
- **banked:** This mode is only available for HCS08 devices with an on-chip MMU. This sets the memory as **banked** (i.e., accessed in the PPAGE window (\$8000-\$BFFF) with PPAGE register handling). The banked type provides the debugger logical display of the memory. A range defined as banked is displayed in the Memory window with a physical/local address in addition to PPAGE << 16. This logical address is therefore only valid in the \$8000-\$BFFF window. For example, an instruction address at \$8050 in PPAGE \$03 is visible in the Memory window at \$038050.
- **EEPROM banked:** This mode is only available for HCS08 devices with an on-chip EEPROM module having several pages. A range defined as EEPROM banked is displayed in the Memory window with a physical/local address in addition to the **bit(s) to switch EEPROM pages << 16**. This logical address is therefore only valid in the EEPROM range window.

Debugging Memory Map

DMM Commands

NOTE By factory/default setup, HCS08 DBG08 Fifo Registers have been protected to reserve the DBG08 Fifo Reading for the debugger DBG interface. Removing this protection leads to incorrect program flow rebuild.

ColdFire CPU

The following types and priorities are available for the ColdFire CPU.

Priorities:

- **highest (debugger)**: a high debugger priority that can be used by the user or defined for the debugger; typically used to protect a memory area from being read.
- **default (device)**: default CPU visibility of the entire device/memory with the same priority, so no memory range can be moved to overlap another memory range.
- **lowest (debugger)**: a low debugger priority that can be used by the user or defined for the debugger typically to protect a memory area from being read. This priority is of poor usage but can still be used for display purposes on chip unimplemented memory range.

Types:

- **physical**: this sets the memory range as physical, i.e. with **linear 32-bit address bus access as performed by the CPU when reading and writing the on-chip memory**.

DMM Commands

All DMM GUI settings can be done by debugger command line commands.

Debugging Memory Map Manager command set

The commands allow the user to fully script the debugging device memory mapping. Limit the usage of these commands to special debugging purposes, as the default mapping is typically sufficient. A script setup may be complex and may lead to debugger malfunctions.

List of commands

```

DMM
DMM ADD <parameters>
DMM DEL <module handle>
DMM SAVE <mcuid>
DMM DELETEALLMODULES
DMM RELEASECACHES
DMM CACHINGON|CACHINGOFF
DMM WRITEREADBACKON|WRITEREADBACKOFF
DMM HCS12MERHANDLINGON|HCS12MERHANDLINGOFF
DMM OPENGUI [mcuid]
DMM SETAHEADREADSIZE <front size when halted> <back size
when halted> <front size when running> <back size when
running>

```

DMM command

Syntax

```
DMM
```

Purpose

Displays in the Command window the current DMM "Memory Types", "Overlap Priorities" and memory ranges.

DMM ADD command

Syntax

```

DMM ADD <comment> <address> <size> <handle> <type> <cache
locking> <priority> <mapping> <access while running>
<access kind> <access size>

```

with:

<comment> a string for Comment field; "£" must be used for " " (space).

Debugging Memory Map

DMM Commands

<address> the start address of the memory range

<size> the size of the memory range

<handle> a long value for the DMM to handle the memory range (duplicated handled is not allowed).

WARNING! User defined handles must be a value superior or equal to 100.

<type> a value corresponding to a memory type handle, as given/listed with the DMM command.

<cache locking> a "0" or "1" value, "0" forcing the memory range to be refreshed after each debugger halting.

<priority> a value corresponding to an overlap priority handle/value, as given/ listed with the DMM command.

<mapping> a "0" or "1" value, "1" enabling the memory range mapping.

<access while running> a "0" or "1" value, "1" enabling the memory range access while running.

<access kind> "0" for R/W, "1" for write only, "2" for read only, "3" for none.

Purpose

Insert a new memory range in the DMM, as if added via the DMM dialog/user interface.

DMM DEL command

Syntax

DEL <module handle>

with <module handle>, a memory range module handle as given/listed with the DMM command.

Purpose

Delete one specific DMM memory range module by handle reference.

DMM SAVE command

Syntax

```
DMM SAVE <mcuid>
```

with <mcuid>, a part/device MCUID value in range \$0-\$FFFF.

Purpose

Saves the DMM current setup in current `project.ini` file, under "DMM_MCUIDxxxxx_MODULEn=..." keys.

DMM DELETEALLMODULES command

Syntax

```
DMM DELETEALLMODULES
```

Purpose

Removes all current DMM memory range modules. Useful to start a scripted DMM setup.

DMM RELEASECACHES command

Syntax

```
DMM RELEASECACHES
```

Purpose

Flushes once all currently cached data for each memory range module, even if the cache locking is active, i.e. no refresh on halting is active.

Debugging Memory Map

DMM Commands

DMM CACHINGON command

Syntax

DMM CACHINGON

Purpose

Data caching is engaged (default DMM setup). No refresh on halting is active for memory range modules defined with this option.

DMM CACHINGOFF command

Syntax

DMM CACHINGOFF

Purpose

Data caching is disabled. The debugger flushes all caches even for memory range modules defined without this option. Each time the debugger halts, the memory data are retrieve from the target hardware for all memory range modules.

DMM WRITEREADBACKON command

Syntax

DMM WRITEREADBACKON

Purpose

DMM WRITEREADBACKOFF command

Syntax

```
DMM WRITEREADBACKOFF
```

Purpose

DMM HCS12MERHANDLINGON command

Syntax

```
DMM HCS12MERHANDLINGON
```

Purpose

Not relevant for HCS08 and ColdFire cores. Enables the handling of Memory Expansion Registers for HCS12 devices, i.e. INITRM, INITRG and INITEE. The DMM remaps automatically memory range module addresses according to the real value of these registers when halting.

NOTE The debugger does not poll the MER registers while running. Also the remapping is performed only on factory defined memory range modules, not user defined memory range modules.

DMM HCS12MERHANDLINGOFF command

Syntax

```
DMM HCS12MERHANDLINGOFF
```

Purpose

Not relevant for HCS08 and ColdFire cores. Disables completely the feature here above.

Debugging Memory Map

DMM Commands

DMM OPENGUI command

Syntax

```
DMM OPENGUI [mcuid]
```

with <mcuid>, a part/device MCUID value in range \$0-\$FFFF.

Purpose

Opens the DMM Graphical User Interface. Note that the MCUID parameter is not mandatory.

DMM SETAHEADREADSIZE command

Syntax

```
DMM SETAHEADREADSIZE <front size when halted> <back size when halted> <front size when running> <back size when running>
```

with:

<front size when halted>: amount of bytes to read ahead of exact start of read block address, when the hardware is halted.

<back size when halted>: amount of bytes to read after the exact block of read addresses, when the hardware is halted.

<front size when running>: amount of bytes to read ahead of exact start of read block address, when the hardware is running.

<back size when running>: amount of bytes to read after the exact block of read addresses, when the hardware is running.

Purpose

Special debugger memory cache tuning in case of slow connection with hardware.

Book VII - Commands

Book VII Contents

Each section of the Debugger manual includes information to help you become more familiar with the Debugger, to use all its functions and help you understand how to use the environment. This book, the Debugger Commands, defines the HC(S)08 and RS08 commands.

This book contains the following chapter:

Book 7: Commands

- [Debugger Engine Commands](#)



Book VII Contents

Debugger Engine Commands

Commands Overview

The debugger supports scripting with the use of commands and command files. When you script the debugger, you can automate repetitive, time-consuming, or complex tasks.

You do not need to use or have knowledge of commands to run the Simulator/Debugger. However these commands are useful for editing debugger command files, for example, after a recording session, to generate your own command files, or to set up your applications and targets, etc.

This section provides a detailed list of all Simulator/Debugger commands. All command names and component names are case insensitive. The command EBNF syntax is:

```
component [ :component number ] < ] command
```

where **component** is the name of the window component. For example: Data, Register, Source, Assembly, etc. **Component number** is the number of the component. This number does not exist in the component window title if only one component of this type is open. For example, if you open a second Memory component window, the initial Memory component window is renamed **Memory:1** and the new one is called **Memory:2**. A number is automatically associated with a component if there are several components of the same type displayed.

Command Example:

```
in>Memory:2 < SMEM 0x8000,8
```

'<' redirects a command to a specific component (in this example: **Memory:2**). Some commands are valid for several or all components; if the command is not redirected to a specific component, all components are affected. Also, a mismatch can occur because a command's parameters may differ for different components.

Command Syntax

To display the syntax of a command, type the command followed by a question mark.

Syntax Example:

```
in>printf?
```

```
PRINTF (<format>, <expression>, <expression>, ...)
```

Available Command Lists

Commands described on the following pages are sorted into 5 groups, according to their specific actions or targets. However, these groups have no relevance in the use of these commands. A list of all commands in their respective group is given below.

Kernel Commands

Kernel commands are commands that can be used to build command programs. They can only be used in a debugger command file, since the Command Line component can only accept one command at a time. It is possible to build powerful programs by combining Kernel commands with Base commands, Common commands and Component specific commands. [Table 34.1](#) contains all available Kernel commands.

Table 34.1 List of Kernel Commands

Command, Syntax	Short Description
A	Affects a value
AT	Sets a time delay for command execution
CALL fileName[:C][:NL]	Executes a command file
DEFINE symbol [=] expression	Defines a user symbol
ELSE	Other operation associated with IF command
ELSEIF condition	Other conditional operation associated with IF command
ENDFOCUS	Resets the current focus (refer to FOCUS command)
ENDFOR	Exits a FOR loop
ENDIF	Exits an IF condition

Table 34.1 List of Kernel Commands (continued)

Command, Syntax	Short Description
ENDWHILE	Exits a WHILE loop
FOCUS component	Sets the focus on a specified component
FOR [variable =]range [“,” step]	FOR loop instruction
FPRINTF (fileName,format,parameters)	FPRINTF instruction
GOTO label	Unconditional branch to a label in a command file
GOTOIF condition Label	Conditional branch to a label in a command file
IF condition	Conditional execution
PAUSETEST	Displays a modal message box
PRINTE (“Text:,” value))	PRINT instruction
REPEAT	REPEAT loop instruction
RETURN	Returns from a CALL command
TESTBOX	Displays a message box with a string
UNDEF symbol *	Undefines a user defined symbol
UNTIL condition	Condition of a REPEAT loop
WAIT [time] [:s]	Command file execution pause
WHILE condition	WHILE loop instruction

Base Commands

Base commands are used to monitor the Simulator/Debugger target execution. Target input/output files, target execution control, direct memory editing, breakpoint management and CPU register setup are handled by these commands. Base commands can be executed independent of components that are open. [Table 34.2](#) contains all available Base commands.

Table 34.2 List of Base Commands

Command, Syntax	Short Description
BC address!*	Deletes a breakpoint (breakpoint clear)
BS address/function [PIT[state]]	Sets a breakpoint (breakpoint set)
CD [path]	Changes the current working directory
CR [fileName][:A]	Opens a record file (command records)
DASM [address range][:OBJ]	Disassembles
DB [address range]	Displays memory bytes
DL [address range]	Displays memory bytes as longwords
DW [address range]	Displays memory bytes as words
G [address]	Starts execution of the application currently loaded
GO [address]	Starts execution of the application currently loaded
LF [fileName][:A]	Opens a log file
LOG type [=] state {[, type [=] state}	Enables or disables logging of a specified information type
MEM	Displays the memory map
MS range list	Sets memory bytes
NOCR	Closes the record file
NOLF	Closes the log file
P [address]	Single assembly steps into program
RESTART	Restarts the loaded application
RD [list!*	Displays the content of registers

Table 34.2 List of Base Commands (continued)

Command, Syntax	Short Description
RS register[=]value{,register[=]value}	Sets a register
S	Stops execution of the loaded application
STEPINTO	Steps to the next source instruction of the loaded application
STEPOUT	Executes program out of a function call
STEPOVER	Steps over the next source instruction of the loaded application
STOP	Stops execution of the loaded application
SAVEBP on/off	Saves breakpoints
T [address][,count]	Traces program instructions at the specified address
WB range list	Writes bytes
WL range list	Writes longwords
WW range list	Writes words

Environment Commands

Simulator/Debugger environment commands are used to monitor the debugger environment, specific component window layouts and framework applications and targets. [Table 34.3](#) contains all available Environment commands.

Table 34.3 List of Environment Commands

Command, Syntax	Short Description
ACTIVATE component	Activates a component window
AUTOSIZE onloff	Autosizes windows in the main window layout
BCKCOLOR color	Sets the background color
CLOSE component *	Closes a component
DDEPROTOCOL ONIOFFISHOWIHIDEISTATUS	Configures the Debugger/Simulator DDE protocol
FONT 'fontName' [size][color]	Sets text font
LOAD applicationName	Loads a framework application (code and debug information)
LOADCODE applicationName	Loads the code of a framework application
LOADSYMBOLS applicationName	Loads debugging information of a framework application
OPEN component [[x y width height][:][ilmax]]	Opens a Windows component
SET targetName	Sets a new target
SLAY fileName	Saves the general window layout

Component Commands

Component common commands are used to monitor component behaviors. They are common to more than one component. [Table 34.4](#) contains all available Component commands.

Table 34.4 List of Component Commands

Command Syntax	Short Description
CMDFILE	Specify a command file state and full name
EXIT	Terminates the application
HELP	Displays a list of available commands
RESET	Resets statistics
SMEM range	Shows a memory range
SMOD module	Shows module information in the destination component
SPC address	Shows the specified address in a component window
SPROC level	Shows information associated with the specified procedure
VER	Displays version number of components and engine

Component Specific Commands

Component specific commands are associated with specific components. [Table 34.5](#) contains all available Component Specific commands.

Table 34.5 List of Component Specific Commands

Command, Syntax	Short Description
ADDXPR "expression"	Adds a new expression in the data component
ATTRIBUTES list	Sets up the display inside a component window
BASE code module	Sets the Profiler base
BD	Displays a list of all breakpoints
CF fileName [;C][;NL]	Executes a command file
CLOCK frequency	Sets the clock speed
COPYMEM <Source addr range> dest-addr	Copies memory
CYCLE on/off	Switches cycles and milliseconds in SofTrace component.
DETAILS assembly source	Sets split view
DUMP	Displays data component content
E expression [;OIDIXICIB]	Evaluates a given expression
EXECUTE fileName	Executes a stimulation file
FILL range value	Fills a memory range with a value
FILTER Options [<range>]	Selects the output file filter options
FIND "string" [;B] [;MC] [;WW]	Finds and highlights a pattern
FINDPROC ProcedureName	Opens a procedure file
FOLD [*]	Folds a source block
FRAMES number	Sets the maximum number of frames
GRAPHICS on/off	Switches graphic bars on/off
INSPECTOROUTPUT [name {subname}]	Prints content of Inspector to Command window

Table 34.5 List of Component Specific Commands (continued)

Command, Syntax	Short Description
INSPECTORUPDATE	Updates content of Inspector
LS [symbol *];[CIS]	Displays the list of symbols
NB [base]	Sets the base of arithmetic operations
OUTPUT fileName	Redirects the coverage component results
PTRARRAY on/off	Switches on /off the pointer as array display
RECORD on/off	Switches on/off the frame recorder
SLINE lineNumber	Shows the desired line number
SAVE range fileName [offset];[A]	Saves a memory block in S-Record format
SETCOLORS ("Name") (Background) (Cursor) (Grid) (Line) (Text)	Changes the colors attributes of the "Name" channel from the Monitor component
SREC fileName [offset]	Loads a memory block in S-Record format
TUPDATE on/off	Switches on/off time update for statistics
UNFOLD [*]	Unfolds a source block
UPDATERATE rate	Sets the data and memory update mode
ZOOM address in/out	Zooms in/out a variable

Command Syntax Terms

address

A number matching a memory address. This number must be in the ANSI format (i.e. \$ or 0x for hexadecimal value, 0 for octal, etc.).

Example: 255, 0377, 0xFF, \$FF

NOTE **address** can also be an expression if **constant address** is not specifically mentioned in the command description. An expression can be: Global variables of application, I/O registers defined in DEFAULT.REG, definitions in the command line, or numerical constants.

Example: DEFINE IO_PORT = 0x210

WB IO_PORT 0xFF

range

A composition of two addresses to define a range of memory addresses. Syntax is shown below:

address...address

or

address, size

where **size** is an ANSI format numerical constant.

Example:

0x2F00...0x2FFF

Refers to the memory range starting at **0x2F00** and ending at **0x2FFF** (256 bytes).

Example:

0x2F00,256

Refers to the memory range starting at **0x2F00**, which is 256 bytes wide. Both previous examples are equivalent.

fileName

A DOS file name and path that identifies a file and its location. The command interpreter does not assume any file name extension. Use backslash (\) or slash (/) as a directory delimiter.

The parser is case insensitive. If no path is specified, it looks for (or edits) the file in the current project directory. When no path is specified, the default directory is the project directory.

Example:

```
d:/demo/myfile.txt
```

Example:

```
layout.hwl
```

Example:

```
d:/work/project.hwc
```

component

The name of a debugger component. A list of all debugger components is given by choosing *Component > Open*. The parser is case insensitive.

Example:

```
Memory
```

Example:

```
SoUrCe
```

Module Names

Correct module names are displayed in the Module component window. Make sure that the module name of a command that you implement is correct:

If the `.abs` is in **HIWARE** format, some debug information is in the object file (`.o`), and module names have a `.o` extension (e.g., `fib.o`).

In **ELF** format, module name extensions are `.c`, `.cpp` or `.dbg` (`.dbg` for program sources in assembler) (e.g., `fib.c`), since all debugging information is contained in the `.abs` file and object files are not used.

Debugger Commands

The commands available when you use the Simulator/Debugger are defined on the following pages.

A

The **A** command assigns an expression to an existing variable. The quoted expression must be used for string and enum expressions.

Usage

```
A variable = value or A variable = "value"
```

Components

Debugger engine.

Example:

```
in>a counter=8
```

The variable **counter** is now equal to **8**.

```
in>A day1 = "monday_8U" (Monday_8U is defined in an Enum)
```

The variable **day1** is now equal to **monday_8U**.

```
in>A value = "3.3"
```

The variable **value** is now equal to **3.3**

ACTIVATE

ACTIVATE activates a component window as if you clicked on its title bar. The window is displayed in the foreground and its title bar is highlighted. If the window shows icons, its title bar is activated and displayed in the foreground.

Usage

```
ACTIVATE component
```

Components

Debugger engine.

Example:

```
in>ACTIVATE Memory
```

Activates the Memory Component and brings the window to the foreground.

ADDXPR

The **ADDXPR** command adds a new expression in the data component.

Usage

```
ADDXPR "expression"
```

Where the parameter expression is an expression to be added and evaluated in the data component.

Components

Data component.

Example:

```
in>ADDXPR "counter + 10"
```

The expression "counter +10" is added in the data component.

ATTRIBUTES

This command is effective for various components as described in the next sections.

In the Command Component

The **ATTRIBUTES** command allows you to set the display and state options of the Command component window. The **CACHESIZE** command sets the cache size in lines for the Command Line window: The cache size value is between 10 and 1000000.

NOTE Usually this command is not specified interactively by the user. However this command can be written in a command file or a layout (" .HWL ") file to save and reload component window layouts. An interactive equivalent operation is typically possible, using Simulator/Debugger menus and operations, drag and drops, etc., as described in the following sections in "Equivalent Operations".

Debugger Engine Commands

Debugger Commands

Usage

```
ATTRIBUTES list
where list=command{ ,command}
command=CACHESIZE value
```

Example:

```
command < ATTRIBUTES 2000
```

In the Procedure Component

The **ATTRIBUTES** command allows you to set the display and state options of the Procedure component window. The **VALUES** and **TYPES** commands display or hide the Values or Types of the parameters.

Usage

```
ATTRIBUTES list
where list=command{ ,command}
command=VALUES (ON|OFF) | TYPES (ON|OFF)
```

Example:

```
Procedure < ATTRIBUTES VALUES ON, TYPES ON
```

In the Assembly Component

The **ATTRIBUTES** command allows you to set the display and state options for the Assembly component window. The **ADR** command displays or hides the address of a disassembled instruction. **ON | OFF** is used to switch the address on or off. **SMEM** (show memory range) and **SPC** (show PC address) scroll the Assembly component to the corresponding address or range code location and select/highlight the corresponding assembler lines or range of code. The **CODE** command displays or hides the machine code of the disassembled instruction. **ON | OFF** is used to switch on or off the machine code. The **ABSADR** command shows or hides the absolute address of a disassembled instruction like 'branch to'. **ON | OFF** is used to switch on or off the absolute address. The **TOPPC** command scrolls the Assembly component in order to display the code location given as an argument on the first line of Assembly component window. The **SYMB** command displays or hides the symbolic names of objects. **ON | OFF** is used to switch the symbolic display on or off.

Usage

```
ATTRIBUTES list
```



```

where list=command{ ,command}
command= ADR (ON|OFF) |
SMEM range |
SPC address |
CODE (ON|OFF) |
ABSADR (ON|OFF) |
TOPPC address |
SYMB (ON|OFF)

```

NOTE Also refer to [SMEM](#) and [SPC](#) command descriptions for more detail about these commands. The **SPC** command is similar to the **TOPPC** command but also highlights the code and does not scroll to the top of the component window.

Equivalent Operations

- ATTRIBUTES ADR ~ Select menu *Assembly > Display Adr*
- ATTRIBUTES SMEM ~ Select a range in Memory component window and drag it to the Assembly component window.
- ATTRIBUTES SPC ~ Drag a register to the Assembly component window.
- ATTRIBUTES CODE ~ Select menu *Assembly > Display Code*
- ATTRIBUTES SYMB ~ Select menu *Assembly > Display Symbolic*

Example

```

Assembly < ATTRIBUTES ADR ON, SYMB ON, CODE ON, SMEM
0x800, 16

```

Addresses, hexadecimal codes, and symbolic names are displayed in the Assembly component window, and assembly instructions at addresses 0x800,16 are highlighted.

In the Register Component

The **ATTRIBUTES** command allows you to set the display and state options of the Register component window.

The **FORMAT** command sets the display format of register values.

The **VSCROLLPOS** command sets the current absolute position of the vertical scroll box (the **vposition** value is in **lines**: each register and bitfield have the same height, which is the height of a **line**). **vposition** is the absolute vertical scroll position. The value **0** represents the first position at the top.

Debugger Engine Commands

Debugger Commands

The **HSCROLLPOS** command sets the position of the horizontal scroll box (the **hposition** value is in **columns**: a **column** is about a tenth of the greatest register or bitfield width). **hposition** is the absolute horizontal scroll position. The value **0** represents the first position on the left.

The parameters **vposition** and **hposition** can be constant expressions or symbols defined with the **DEFINE** command.

The **COMPLEMENT** command sets the display complement format of register values:

- one sets the first complement (each bit is reversed),
- none deselects the first complement.

An error message is displayed if:

- the parameter is a negative value
- the scroll box is not visible

If the given scroll position is bigger than the maximum scroll position, the current absolute position of the scroll box is set to the maximum scroll position.

Equivalent Operations

- ATTRIBUTES FORMAT ~ Select menu *Register > Options*
- ATTRIBUTES VSCROLLPOS ~ Scroll vertically in the Register component window.
- ATTRIBUTES HSCROLLPOS ~ Scroll horizontally in the Register component window.
- ATTRIBUTES COMPLEMENT ~ Select menu *Register > Options*

Usage

```
ATTRIBUTES list
where list=command{,command}
command= FORMAT (hex|bin|dec|udec|oct) | VSCROLLPOS
vposition | HSCROLLPOS hposition | COMPLEMENT(none|one)
Where vposition=expression and hposition=expression
```

Example

```
in>Register < ATTRIBUTES FORMAT BIN
```

Contents of registers are displayed in binary format in the Register component window.

```
in>Register < ATTRIBUTES VSCROLLPOS 3
```

Scrolls three positions down. The third line of registers is displayed on the top of the register component.

```
in>Register < ATTRIBUTES VSCROLLPOS 0
```

Returns to the default display. The first line of registers is displayed on the top of the register component.

```
in>DEFINE vpos = 5
```

```
in>Register < ATTRIBUTES HSCROLLPOS vpos
```

Scrolls five positions right. The second column of registers is displayed on the left of the register component.

```
in>Register < ATTRIBUTES HSCROLLPOS 0
```

Returns to the default display. The first column of registers is displayed on the left of the register component.

```
in>Register < ATTRIBUTES COMPLEMENT One
```

Sets the first complement display option. All registers are displayed in reverse bit.

In the Source Component

The **ATTRIBUTES** command allows you to set the display and state options of the Source component window. The **SMEM** (show memory range) command and **SPC** (show PC address) command loads the corresponding module's source text, scrolls to the corresponding text range location or text address location and highlights the corresponding statements. The **SMOD** (show module) command loads the corresponding module's source text. If the module is not found, a message is displayed in the [Component Windows Object Info Bar](#). The **SPROC** (show procedure) command loads the corresponding module's source text, scrolls to the corresponding procedure and highlights the statement, that is in the procedure chain of this procedure. The **numberAssociatedToProcedure** is the level of the procedure in the procedure chain. The **MARKS** command (**ON** or **OFF**) displays or hides the marks.

NOTE Also refer to [SMEM SPC](#), [SPROC](#) and [SMOD](#) command descriptions for more detail about these commands.

Equivalent Operations

- ATTRIBUTES SPC ~ Drag and drop from Register component to Source component.
- ATTRIBUTES SMEM ~ Drag and drop from Memory component to Source component.

Debugger Engine Commands

Debugger Commands

- ATTRIBUTES SMOD ~ Drag and drop from Module component to Source component.
- ATTRIBUTES SPROC ~ Drag and drop from Procedure component to Source component.
- ATTRIBUTES MARKS ~ Select menu *Source > Marks*.

Usage

```
ATTRIBUTES list
where list=command{,command}
command= SPC address |
SMEM range |
SMOD module (without extension) |
SPROC numberAssociatedToProcedure |
MARKS (ON|OFF)
```

Example

```
in>Source < ATTRIBUTES MARKS ON
Marks are visible in the Source component window.
```

In the Data Component

The **ATTRIBUTES** command allows you to set the display and state options of the Data component window. The **FORMAT** command selects the format for the list of variables. The format is one of the following: binary, octal, hexadecimal, signed decimal, unsigned decimal or symbolic.

Usage

```
ATTRIBUTES list
where list=command{,command})
command=FORMAT(bin|oct|hex|signed|unsigned|symb) | S
COPE (global|local|user) |
MODE (automatic|periodical| locked|frozen) |
SPROC level |
SMOD module |
UPDATERATE rate |
COMPLEMENT(none|one) |
NAMEWIDTH width
```

The **MODE** command selects the display mode of variables.

- In **Automatic** mode (default), variables are updated when the target is stopped. Variables from the currently executed module or procedure are displayed in the data component. Variables are updated when target is stopped.
- In **Locked** and **Frozen** mode, variables from a specific module are displayed in the data component. The same variables are always displayed in the data component.
- In **Locked** mode, values from variables displayed in the data component are updated when the target is stopped.
- In **Frozen** mode, values from variables displayed in the data component are not updated when the target is stopped.
- In **Periodical** mode, variables are updated at regular time intervals when the target is running. The default update rate is 1 second, but it can be modified by steps of up to 100 ms using the associated dialog box or the **UPDATERATE** command.

The **UPDATERATE** command sets the variables update rate (see also [UPDATERATE](#) command).

The **SPROC** (show procedure) and **SMOD** (show module) commands display local or global variables of the corresponding procedure or module.

The **SCOPE** command selects and displays global, local or user defined variables.

The **COMPLEMENT** command sets the display complement format of Data values: one sets the first complement (each bit is reversed), none deselects the first complement.

The **NAMEWIDTH** command sets the length of the variable name displayed in the window.

NOTE Refer to [SPROC](#), [UPDATERATE](#) and [SMOD](#) command descriptions for more detail about these commands.

Equivalent Operations

- ATTRIBUTES FORMAT ~ Select menu *Data > Format*
- ATTRIBUTES MODE ~ Select menu *Data > Mode*
- ATTRIBUTES SCOPE ~ Select menu *Data > Scope*
- ATTRIBUTES SPROC ~ Drag and drop from Procedure component to Data component.
- ATTRIBUTES SMOD ~ Drag and drop from Module component to Data component.

Debugger Engine Commands

Debugger Commands

- ATTRIBUTES UPDATERATE ~ Select menu *Data > Mode > Periodical*
- ATTRIBUTES COMPLEMENT ~ Select menu *Data > Format*
- ATTRIBUTES NAMEWIDTH ~ Select menu *Data > Options > Name Width*

Example

```
Data:1 < ATTRIBUTES MODE FROZEN
```

In **Data:1** (global variables), variables update is frozen mode. Variables are not refreshed when the application is running.

In the Memory Component

- The **ATTRIBUTES** command allows you to set the display and state options of the Memory component window.
- The **WORD** command selects the word size of the memory dump window. The word size **number** is:
 - **1**, for byte format;
 - **2**, for word format (2 bytes); or
 - **4**, for long format (4 bytes).
- The **ADR** command **ON** or **OFF** displays or hides the address in front of the memory dump lines.
- The **ASC** command **ON** or **OFF** displays or hides the ASCII dump at the end of the memory dump lines.
- The **ADDRESS** command scrolls the corresponding memory dump window and displays the corresponding memory address lines (memory **WORD** is not selected).
- **SPC** (show pc), **SMEM** (show memory) and **SMOD** (show module) commands scroll the Memory component accordingly, to display the code location given as argument, and select the corresponding memory area
 - **SPC** selects an address,
 - **SMEM** selects a range of memory and
 - **SMOD** selects the module name for the global variable located in the window.
- The **FORMAT** command selects the format for the list of variables. The format is one of the following:
 - binary,
 - octal,
 - hexadecimal,

- signed decimal,
- unsigned decimal or
- symbolic.
- The **COMPLEMENT** command sets the display complement format of memory values: one sets the first complement (each bit is reversed), none deselects the first complement.
- The **MODE** command selects the display mode of memory words.
 - In **Automatic** mode (default), memory words are updated when the target is stopped. Memory words from the currently executed module or procedure are displayed in the Memory component. Memory words are updated when target is stopped.
 - In **Frozen** mode, value from memory words displayed in the Memory component are not updated when the target is stopped.
 - In **Periodical** mode, memory words are updated at regular time intervals when the target is running. The default update rate is 1 second, but it can be modified by steps of up to 100 ms using the associated dialog box or **UPDATERATE** command.
- The **UPDATERATE** command sets the variables update rate (see also [UPDATERATE](#) command).

NOTE Also refer to [SMEM](#), [SPC](#) and [SMOD](#) command descriptions for more detail about these commands.

Equivalent Operations

- ATTRIBUTES FORMAT ~ Select menu *Memory > Format*
- ATTRIBUTES WORD ~ Select menu *Memory > Word Size*
- ATTRIBUTES ADR ~ Select menu *Memory > Display > Address*
- ATTRIBUTES ASC ~ Select menu *Memory > Display > ASCII*
- ATTRIBUTES ADDRESS ~ Select menu *Memory > Address*
- ATTRIBUTES COMPLEMENT ~ Select menu *Memory > Format*
- ATTRIBUTES SMEM ~ Drag and drop from Data component (variable) to Memory component.
- ATTRIBUTES SMOD ~ Drag and drop from Source component to Memory component.
- ATTRIBUTES MODE ~ Select menu *Memory > Mode*
- ATTRIBUTES UPDATERATE ~ Select menu *Memory > Mode > Periodical*

Debugger Engine Commands

Debugger Commands

Usage

```

ATTRIBUTES list
where list=command{,command}
command=FORMAT(bin|oct|hex|signed|unsigned) |
WORD number |
ADR (ON|OFF) |
ASC (ON|OFF) |
ADDRESS address |
SPC address |
SMEM range |
SMOD module |
MODE (automatic|periodical| frozen) |
UPDATERATE rate |
COMPLEMENT (NONE|ONE)

```

Example:

```

Memory < ATTRIBUTES ASC OFF, ADR OFF

```

ASCII dump and addresses are removed from the Memory component window.

In the Inspector Component

The **ATTRIBUTES** command allows you to set the display and state of the Inspector component window.

Usage

```

ATTRIBUTES list
where list=command{,command}
command= COLUMNWIDTH columnname columnfield columnsize |
EXPAND [name {subname}] deep |
COLLAPSE name {subname} |
SELECT name {subname} |
SPLIT pos |
MAXELEM ( ON | OFF ) [number] |
FORMAT (Hex|Int)

```

The **COLUMNWIDTH** command sets the width of one column entry on the right pane of the Inspector Window. The first parameter (columnname) specifies which column. The following column names currently exist:

- Names - simple name list
- Interrupts - interrupt list
- SymbolTableFunction - function in the Symbol Table
- ObjectPoolObject - Object in Object Pool without additional information
- Events - event list
- Components - component list
- SymbolTableVariable - variable or differentiation in the Symbol Table
- ObjectPoolIOBase - Object in Object Pool with additional information
- SymbolTableModules - non IOBase derived Object in the Object Pool

The column field is the name of the specific field, which is also displayed in the Inspector Window.

The following commands set the width of the function names to 100:

```
inspect < ATTRIBUTES COLUMNWIDTH SymbolTableModules Name
100
```

NOTE Due to the “inspect <“ redirection, only the Inspector handles this command.

The **EXPAND** command computes and displays all subitems of a specified item up to a given depth. An item is specified by specifying the complete path starting at one of the root items like “Symbol Table” or “Object Pool”. Names with spaces must be surrounded by double quotes.

To expand all subitems of `TargetObject` in the Object Pool up to four levels, the following command can be used:

```
inspect < ATTRIBUTES EXPAND "Object Pool" TargetObject 4
```

NOTE Because the name Object Pool contains a space, it must be surrounded by double quotes.

NOTE The symbol Table, Stack or other Items may have recursive information. So it may occur that the information tree grows with the depth. Therefore, specifying large expand values may use a large amount of memory.

Debugger Engine Commands

Debugger Commands

The **COLLAPSE** command folds one item. The item name must be given. The following command folds the TargetObject:

```
inspect < ATTRIBUTES COLLAPSE "Object Pool" TargetObject
```

The **SELECT** command shows the information of the specified item on the right pane. The following command shows all Objects attached to the TargetObject:

```
inspect < ATTRIBUTES SELECT "Object Pool" TargetObject
```

The **SPLIT** command sets the position of the split line between the left and right pane. The value must be between 0 and 100. A value of 0 only shows the right pane, a value of 100 shows the left pane. Any value between 0 and 100 makes a relative split. The following command makes both panes the same size:

```
inspect < ATTRIBUTES SPLIT 50
```

The **MAXELEM** command sets the number of subitems to display. After the following command, the Inspector prompts for 1000 subitems:

```
inspect < ATTRIBUTES MAXELEM ON 1000
```

The **FORMAT** command specifies whether to display integral values like addresses as hexadecimal or decimal. The following command specifies the hexadecimal display:

```
inspect < ATTRIBUTES FORMAT Hex
```

Equivalent Operations

- ATTRIBUTES COLUMNWIDTH ~ Modify column width with the mouse.
 - ATTRIBUTES EXPAND ~ Expand any item with the mouse.
 - ATTRIBUTES COLLAPSE ~ Collapse the specified item with the mouse.
 - ATTRIBUTES SELECT ~ Click on the specified item to select it.
 - ATTRIBUTES SPLIT ~ Move the split line between the panes with the mouse.
 - ATTRIBUTES MAXELEM ~ Select **max. Elements...** from the context menu.
-

AT

The **AT** command temporarily suspends a command file from executing until after a specified delay in milliseconds. The delay is measured from the time the command file is started. In the event that command files are chained (one calling another), the delay is measured from the time the first command file is started.

NOTE This command can only be executed from a command file. The time specified is relative to the start of command file execution.

Usage

`AT time`

where `time=expression` and `expression` is interpreted in milliseconds.

Components

Debugger engine.

Example:

```
AT 10 OPEN Command
```

This command (in command file) opens the **Command Line component** 10 ms after the command file is executed.

Debugger Engine Commands

Debugger Commands

AUTOSIZE

AUTOSIZE enables/disables windows autosizing. When on, the size of component windows are automatically adapted to the Simulator/Debugger main window when it is resized.

Usage

```
AUTOSIZE on|off
```

Components

Debugger engine.

Example:

```
in>AUTOSIZE off
```

Windows autosizing is disabled.

BASE

In the Profiler component, the **BASE** command sets the profiler base to **code** (total code) or **module** (each module code).

Usage

```
BASE code|module
```

Components

Profiler component.

Example:

```
in>BASE code
```

BC

BC deletes a breakpoint at the specified address. When * is specified, all breakpoints are deleted.

You can point to the breakpoint in the Assembly or Source component window, right-click and choose **Delete Breakpoint** in the context menu, or open the ControlPoints Window, select the breakpoint from the list and click **Delete**.

NOTE Correct module names are displayed in the Module component window. Make sure that the module name of your command is correct: if the .abs is in **HIWARE** format, some debug information is in the object file (.o), and module names have a .o extension (e.g., fibo.o). In **ELF** format, module name extensions are .c, .cpp or .dbg (.dbg for program sources in assembler) (e.g., fibo.c), since all debugging information is contained in the .abs file and object files are not used. Adapt the following examples with your .abs application file format.

Usage

```
BC address|*
```

address is the address of the breakpoint to be deleted. This address is specified in ANSI C or standard Assembler format. **address** can also be replaced by an **expression** as shown in the example below.

When * is specified all breakpoints are deleted.

Components

Debugger engine.

Example1:

```
in>BC 0x8000
```

This command deletes the breakpoint set at the address 0x8000. The breakpoint symbol is removed in the source and assembly window. The breakpoint is removed from the breakpoint list.

Example 2:

```
in>BC &FIBO.C:Fibonacci
```

In this example, an **expression** replaces the address. FIBO.C is the module name and Fibonacci is the function where the breakpoint is cleared.

Debugger Engine Commands

Debugger Commands

BCKCOLOR

BCKCOLOR sets the background color.

The background color defined with the **BCKCOLOR** command is valid for all component windows. Avoid using the same color for the font and background, otherwise text in the component windows is not visible. Also avoid using colors that have a specific meaning in the command line window. These colors are:

Red: used to display error messages.

Blue: used to echo commands.

Green: used to display asynchronous events.

NOTE When **WHITE** is given as a parameter, the default background color for all component windows is set, for example, the register component is lightgray.

Usage

```
BCKCOLOR color
```

Where **color** can be one of the following: **BLACK**, **GREY**, **LIGHTGREY**, **WHITE**, **RED**, **YELLOW**, **BLUE**, **CYAN**, **GREEN**, **PURPLE**, **LIGHTRED**, **LIGHTYELLOW**, **LIGHTBLUE**, **LIGHTCYAN**, **LIGHTGREEN**, **LIGHTPURPLE**

Components

Debugger engine.

Example:

```
in>BCKCOLOR LIGHTCYAN
```

The background color of all currently open component windows is set to Lightcyan. To return to the original display, enter **BCKCOLOR WHITE**.

BD

In the Command Line component, the **BD** command displays the list of all breakpoints currently set with addresses and types (temporary, permanent).

Usage

```
BD
```

Components

Debugger engine.

Example:

```
in>BD
Fibonacci 0x805c T
Fibonacci 0x8072 P
Fibonacci 0x8074 T
main 0x8099 T
```

One permanent and two temporary breakpoints are set in the function **Fibonacci**, and one temporary breakpoint is set in the **main** function.

NOTE From the list, it is not possible to know if a breakpoint is disabled or not.

BS

BS sets a temporary (**T**) or a permanent (**P**) breakpoint at the specified address. If no **P** or **T** is specified, the default is a permanent (**P**) breakpoint.

Equivalent Operation

You can point at a statement in the Assembly or Source component window, right-click and choose **Set Breakpoint** in the context menu, or open the Controlpoints Configuration Window and choose **Show Breakpoint**, then select the breakpoint and set its properties.

NOTE Correct module names are displayed in the Module component window. Make sure that the module name of your command is correct:

If the `.abs` is in **HIWARE** format, some debug information is in the object file (`.o`), and module names have a `.o` extension (e.g., `fibonacci.o`). In **ELF** format, module name extensions are `.c`, `.cpp` or `.dbg` (`.dbg` for program sources in assembler) (e.g., `fibonacci.c`), since all debugging information is contained in the `.abs` file and object files are not used. Adapt the following examples with `.abs` application file format.

Debugger Engine Commands

Debugger Commands

Usage

```
BS address| function [{mark}]
[P|T[ state]][;cond="condition"[ state]]
[;cmd="command"[ state]][;cur=current[ inter=interval]]
[;cdSz=codeSize[ srSz=sourceSize]]
```

address is the address where the breakpoint is to be set. This address is specified in ANSI C format. **address** can also be replaced by an **expression** as shown in the example below.

function is the name of the function in which to set the breakpoint.

mark (displayed mark in Source component window) is the mark number where the breakpoint is to be set. When mark is:

- > 0: the position is relative to the beginning of the function.
- = 0: the position is the entry point of the function (default value).
- < 0: the position is relative to the end of the function.

P, specifies the breakpoint as a permanent breakpoint.

T, specifies the breakpoint as a temporary breakpoint. A temporary breakpoint is deleted once it is reached.

State is **E** or **D** where **E** is for enabled (state is set by default to **E** if nothing is specified), and **D** is for disabled.

condition is an **expression**. It matches the **Condition** field in the Controlpoints Configuration window for a conditional breakpoint.

command is any Debugger command (at this level, the commands **G**, **GO** and **STOP** are not allowed). It matches the **Command** field in the Controlpoints Configuration window, for associated commands. For the **Command** function, the states are **E (enabled)** or **C (continue)**.

current is an **expression**. It matches the **Current** field (**Counter**) in the Controlpoints Configuration window, for counting breakpoints.

interval is an **expression**. It matches the **Interval** field (**Counter**) in the Controlpoints Configuration window, for counting breakpoints.

codeSize is an **expression**. It is usually a constant number to specify (for security) the code size of a function where a breakpoint is set. If the size specified does not match the size of the function currently loaded in the .ABS file, the breakpoint is set but disabled.

sourceSize is an **expression**. It is usually a constant number to specify (for security) the source (text) size of a function where a breakpoint is set. If the size specified does not match the size of the function in the source file, the breakpoint is set but disabled.

Components

Debugger engine.

Example:

```
in>BS 0x8000 T
```

This command sets a temporary breakpoint at the address 0x8000.

```
in>BS $8000
```

This command sets a permanent breakpoint at the address 0x8000.

```
BS &FIBO.C:Fibonacci
```

In this example, an **expression** replaces the address. FIBO.C is the module name and Fibonacci is the function where the breakpoint is set.

More Examples:

```
in>BS &main + 22 P E ; cdSz = 66 srSz = 134
```

Sets a breakpoint at the address of the main procedure + 22, where the code size of the main procedure is 66 bytes and its source size is 134 characters.

```
in>BS Fibo.c:main{3}
```

Sets a breakpoint at the third mark of the procedure **main**, where **main** is a function of the FIBO.C module.

```
in>BS &counter + 5; cond = "fib1>fib2";cmd="bckcolor red"
```

Sets a breakpoint at the address of the variable **counter** + 5, where the condition is **fib1 > fib2** and the command is **bckcolor red**.

```
in>BS &Fibo.c:Fibonacci+13
```

Sets a breakpoint at the address of the **Fibonacci** procedure + 13, where **Fibonacci** is a function of the FIBO.C module.

CALL

Executes a command in the specified command file.

NOTE If no path is specified, the destination directory is the current project directory.

Usage

```
CALL FileName [;C][;NL]
```

Debugger Engine Commands

Debugger Commands

Components

Debugger engine.

Example:

```
in>cf \util\config.cmd
```

Loads the config command file.

CD

The **CD** command changes the current working directory to the directory specified in path. When the command is entered with no parameter, the current directory is displayed.

The directory specified in the CD command must be a valid directory, that exists and is accessible from the PC. When specifying a relative path in the CD command, make sure the path is relative to the project directory.

NOTE When no path is specified, the default directory is the project directory. Using the CD command may affect any commands which refer to a file with no path specified.

Usage

```
CD [path]
```

path: The pathname of a directory that becomes the current working directory (case insensitive).

Components

Debugger engine.

Example:

```
in>cd..
C:\Program Files\Freescale\demo
in>cd
C:\Program Files\Freescale\demo
in>cd /Freescale/prog
C:\Program Files\Freescale\prog
```

The new project directory is C:\Program
Files\Freescale\CodeWarrior for Microcontrollers
V6.1\prog

CF

The **CF** command reads the commands in the specified command file, which are then executed by the command interpreter. The command file contains ASCII text commands. Command files can be nested. By default, after executing the commands from a nested command file, the command interpreter resumes execution of remaining commands in the calling file. Any error halts execution of **CF** file commands. When the command is entered with no parameter, the **Open File** dialog box is displayed. The **CALL** command is equivalent to the **CF** command.

NOTE If no path is specified, the destination directory is the current project directory.

Usage

```
CF fileName [;C] [;NL]
```

Where **fileName** is a file (and path) containing Simulator/Debugger commands. **;C** specifies chaining the command file. This option is meaningful in a nested command file only.

When the **;C** option is given in the calling file, the command interpreter quits the calling file and executes the called file. (i.e. in the calling file, commands following the **CF ... ;C** command are never executed).

When the option is omitted, execution of the remaining commands in the calling file is resumed after the commands in the called file have been executed.

;NL: when set, the commands that are in the called file are not logged in the Command Line window (and not to log file, when a file has been opened with an [LF](#) command), even if the **CMDFILE** type is set to **ON** (see also the [LOG](#) command).

Components

Debugger engine.

Examples:

```
in>CF commands.txt
```

Executes the **COMMANDS.TXT** file, which contains debugger commands like those described in this chapter.

Debugger Engine Commands

Debugger Commands

Example Without “;C” Option:

If a `command1.txt` file contains:

```
bckcolor green
cf command2.txt
bckcolor white
```

If a `command2.txt` file contains:

```
bckcolor red
```

Execution:

```
in>cf command1.txt
executing command1.txt
```

```
!bckcolor green
!cf command2.txt
executing command2.txt
```

```
1!bckcolor red
1!
1!
done command2.txt
```

```
!bckcolor white
!
done command1.txt
```

Example With “;C” Option:

If a `command1.txt` file contains:

```
bckcolor green
cf command2.txt ;C
bckcolor white
```

If a **command2.txt** file contains:

```
bckcolor red
```

Execution:

```
in>cf command1.txt
```

```
executing command1.txt
```

```
!bckcolor green
```

```
!cf command2.txt ;C
```

```
executing command2.txt
```

```
1!bckcolor red
```

```
1!
```

```
1!
```

```
done command2.txt
```

```
done command1.txt
```

CLOCK

In the SoftTrace component, the **CLOCK** command sets the clock speed.

Usage

```
CLOCK frequency
```

Where number is a decimal number, which is the CPU frequency in Hertz.

Components

SoftTrace component.

Example:

```
in>CLOCK 4000000
```

Debugger Engine Commands

Debugger Commands

CLOSE

The **CLOSE** command is used to close a component.

Component names are: Assembly, Command, Coverage, Data, Inspect, IO_Led, Led, Memory, Module, Phone, Procedure, Profiler, Recorder, Register, SoftTrace, Source, Stimulation.

Usage

```
CLOSE component | *
```

where * means “all components”.

Components

Debugger engine.

Example:

```
in>CLOSE Memory
```

The Memory component window is closed (unloaded).

COPYMEM

The **COPYMEM** command is used to copy a memory range to a destination range defined by the beginning address. This command works on defined memory only. The source range and destination range are tested to ensure they are not overlaid.

Usage

```
COPYMEM <Source address range> dest-address
```

Components

Memory.

Example:

```
in>copymem 0x3FC2A0..0x3FC2B0 0x3FC300
```

The memory from 0x3FC2A0 to 0x3FC2B0 is copied to the memory at 0x3FC300 to 0x3FC310. This Memory range appears in red in the Memory Component.

CMDFILE

The **CMDFILE** command allows you to define all target specific commands in a command file. For example, startup, preload, reset, and path of this file.

Usage

```
CMDFILE <Command File Kind> ON|OFF ["<Command File Full Name>"]
```

Components

Simulator/target engine.

Example:

```
in>cmdfile postload on "c:\temp\myposloadfile.cmd"
```

The `myposloadfile` command file executes after loading the absolute file.

CR

The **CR** command initiates writing records of commands to an external file. Writing records continues until a close record file ([NOCR](#)) command is executed.

NOTE Drag & drop actions are also translated into commands in the record file.

NOTE If no path is specified, the destination directory is the current project directory.

Usage

```
CR [fileName] [;A]
```

If `fileName` is not specified, a standard **Open File** dialog box is opened.

`;A` specifies to open a file `fileName` in append mode. Records are appended at the end of an existing record file.

If the `;A` option is omitted and `fileName` is an existing file, the file is cleared before records are written to it.

Components

Debugger engine.

Debugger Engine Commands

Debugger Commands

Example:

```
in>cr /Freescale/demo/myrecord.txt ;A
```

The myrecord.txt file is opened in “Append” mode for a recording session.

CYCLE

In the **SoftTrace component**, the **CYCLE** command displays or hides cycles. When cycle is off, milliseconds (ms) are displayed.

Usage

```
CYCLE on|off
```

Components

Softtrace component.

Example:

```
in>CYCLE on
```

DASM

The **DASM** command displays the assembler code lines of an application, starting at the address given in the parameter. If there is no parameter, the assembler code following the last address of the previous display is displayed.

This command can be stopped by pressing the **Esc** key.

Equivalent Operation

Right-click in the Assembly component window, select **Address...** and enter the address to start disassembly in the **Show PC** dialog box.

Usage

```
DASM [address|range] [;OBJ]
```

address: A constant expression representing the **address** where disassembly begins.

range: An address range constant that specifies addresses to be disassembled. When **range** is omitted, a maximum of sixteen instructions are disassembled.

When **address** and **range** are omitted, disassembly begins at the address of the instruction that follows the last instruction that has been disassembled by the most recent **DASM** command. If this is the first **DASM** command of a session, disassembly begins at the current address in the program counter.

;OBJ: Displays assembler code in hexadecimal.

Components

Debugger engine.

Example:

```
in>dasm 0xf04b
00F04B LDHX    #0x0450
00F04E TXS
00F04F CLRH
00F050 CLRX
00F051 STX    0x80
00F053 INC    0x80
00F055 LDX    0x80
00F057 JSR    0xF000
00F05A STX    0x82
00F05C STA    0x81
00F05E LDA    #0x17
00F060 CMP    0x80
00F062 BEQ    *-20      /abs = F050
00F064 BRA    *-19      /abs = F053
00F066 DECX
00F067 DECX
```

NOTE Depending on the target, the above code may vary.

Disassembled instructions are displayed in the Command Line component window. Therefore, it is necessary to open the Command Line component before executing this command to see the dumped code.

Debugger Engine Commands

Debugger Commands

DB

The **DB** command displays the hexadecimal and ASCII values of the bytes in a specified range of memory. The command displays one or more lines, depending on the address or range specified. Each line shows the address of the first byte displayed in the line, followed by the number of specified hexadecimal byte values. The hexadecimal byte values are followed by the corresponding ASCII characters, separated by spaces. Between the eighth and ninth values, a hyphen (-) replaces the space as the separator. Each non-displayable character is represented by a period (.).

This command can be stopped by pressing the **Esc** key.

Usage

```
DB [address|range]
```

When **address** and **range** are omitted, the first longword displayed is taken from the address following the last longword displayed by the most recent **DB**, **DW**, or **DL** command, or from address **0x0000** (for the first **DB**, [DW](#), [DL](#) command of a session).

Components

Debugger engine.

Examples:

```
in>DB 0x8000..0x800F
8000: FE 80 45 FD 80 43 27 10-35 ED 31 EC 31 69 70 83
p_Eý_C'.5í111ipf
```

Memory bytes are displayed in the Command Line component window, with matching ASCII characters. So, it is necessary to open the Command Line component before executing this command to see the dumped code.

```
in>DB &TCR
0012: 5A Z
```

displays the byte that is at the address of the TCR I/O register. I/O registers are defined in a `DEFAULT.REG` file.

DDEPROTOCOL

The **DDEPROTOCOL** command is used to configure the Debugger/Simulator dynamic data exchange (DDE) protocol.

By default the DDE protocol is activated and not displayed in the command line component.

Usage

```
DDEPROTOCOL ON | OFF | SHOW | HIDE | STATUS
```

Where:

- ON enables the DDE communication protocol
- OFF disables the DDE communication protocol
- SHOW displays DDE protocol information in the command line component
- HIDE hides DDE protocol information in the command line component
- STATUS provides information if the DDE protocol is active (on or off) and if display is active (Show or Hide)

Components

Debugger engine.

Example:

```
in>DDEPROTOCOL ON
in>DDEPROTOCOL SHOW
in>DDEPROTOCOL STATUS
DDEPROTOCOL ON - DISPLAYING ON
```

The DDE protocol is activated and displayed, and status is given in the command line component.

NOTE For more information on Debugger/Simulator DDE implementation, refer to the [Debugger DDE Capabilities](#) chapter.

Debugger Engine Commands

Debugger Commands

DECODE_SKIP

In the **HC08 CPU** and **HCS08 CPU** components, the `DECODE_SKIP` command defines usage of `SKIP`/`SKIP2` pseudo instructions.

NOTE The compiler generates these pseudo instructions by default in order to optimize code size and speed.

Usage

```
DECODE_SKIP NO | SKIP | ALL | INFO
```

Where:

- `NO` decodes `BRN` and `CPHX #xxxx` instructions as is
- `SKIP` decodes `BRN` as `SKIP` pseudo instruction (default)
- `ALL` decodes `BRN` as `SKIP` and `CPHX #xxxx` as `SKIP2` pseudo instructions
- `INFO` provides information if `BRN` is decoded as `SKIP` and if `CPHX #xxxx` is decoded as `SKIP2`

Components

HC08 CPU, HCS08 CPU (also affected: Assembly and Trace components)

Example:

```
in>DECODE_SKIP ALL
```

```
in>DECODE_SKIP INFO
```

```
ALL (decode BRN as SKIP and CPHX #xxxx as SKIP2 instructions)
```

Decoding `BRN` as `SKIP` and `CPHX #xxxx` as `SKIP2` is set and information about it is displayed in the command line component.

DEFINE

The **DEFINE** command creates a symbol and associates the value of an expression with it. Arithmetic expressions are evaluated when the command is interpreted. The symbol can be used to represent the expression until the symbol is redefined, or undefined using the **UNDEF** command. A symbol is a maximum of 31 characters long. In a command line, all symbol occurrences (after the command name) are substituted by their values before

processing starts. A symbol cannot represent a command name. Note that a symbol definition precedes (and hence conceals) a program variable with the same name.

Defined symbols remain valid when a new application is loaded. An application variable or I/O register can be overwritten with a **DEFINE** command.

NOTE This command can be used to assign meaningful names to expressions, which can be used in other commands. This increases the readability of command files and avoids re-evaluation of complex expressions.

Usage

```
DEFINE symbol [=] expression
```

Components

Debugger engine.

Example:

```
in>DEFINE addr $1000
in>DEFINE limit = addr + 15
```

First `addr` is defined as a constant equivalent to `$1000`. Then `limit` is defined and affected with the value `($1000 + 15)`

A symbol defined in the loaded application can be redefined on the command line using the **DEFINE** command. The symbol defined in the application is not accessible until an **UNDEF** on that symbol name is detected in the command file.

Debugger Engine Commands

Debugger Commands

Example:

A symbol named `testCase` is defined in the test application.

```
/* Loads application test.abs */
LOAD test.abs
/* Display value of testCase. */
DB testCase
/* Redefine symbol testCase. */
DEFINE testCase = $800
/*Display value stored at address $800.*/
DB testCase
/* Redefine symbol testCase. */
UNDEF testCase
/* Display value of testCase. */
DB testCase
```

NOTE Also refer to examples given for the command [UNDEF](#).

DETAILS

In the **Profiler component**, the **DETAILS** command opens a profiler split view in the Source or Assembly component.

Usage

```
DETAILS assembly|source
```

Components

Profiler components.

Example:

```
in>DETAILS source
```

DL

The **DL** command displays the hexadecimal values of the longwords in a specified range of memory. The command displays one or more lines, depending on the address or range specified. Each line shows the address of the first longword displayed in the line, followed by the number of specified hexadecimal longword values.

When a size is specified in the range, this size represents the number of longwords that display in the command line window.

This command can be stopped by pressing the **Esc** key.

NOTE Open the Command Line component before executing this command to see the dumped code.

Usage

```
DL [address | range]
```

When **range** is omitted, the first longword displayed is taken from the address following the last longword displayed by the most recent **DB**, **DW**, or **DL** command, or from address **0x0000** (for the first **DB**, **DW**, **DL** command of a session).

Components

Debugger engine.

Example:

```
in>DL 0x8000..0x8007
8000: FE8045FD 80432710
```

The content of the memory range starting at 0x8000 and ending at 0x8007 is displayed as longword (four bytes) values.

```
in>DL 0x8000,2
8000: FE8045FD 80432710
```

The content of two longwords starting at 0x8000 is displayed as longword values (four bytes).

Memory longwords are displayed in the Command Line component window.

Debugger Engine Commands

Debugger Commands

DUMP

The DUMP command writes everything visible in the Data component to the command line component.

Usage

```
DUMP
```

Components

Data component.

Example:

```
in> Data:1 < DUMP
```

DW

The **DW** command displays the hexadecimal values of the words in a specified range of memory. The command displays one or more lines, depending on the address or range specified. Each line shows the address of the first word displayed in the line, followed by the number of specified hexadecimal word values.

When a size is specified in the range, this size represents the number of words that display in the command line window.

This command can be stopped by pressing the **Esc** key.

NOTE Open the Command Line component before executing this command to see the dumped code.

Usage

```
DW [address | range]
```

When **address** is an address constant expression, the address of the first word is displayed.

When **address** and **range** are omitted, the first word displayed is taken from the address following the last word displayed by the most recent **DB**, **DW**, or **DL** command, or from address **0x0000** (for the first [DB](#), [DW](#), [DL](#) command of a session).

Components

Debugger engine.

Example:

```
in>DW 0x8000,4  
8000: FE80 45FD 8043 2710
```

The content of four words starting at 0x8000 is displayed as word values (two bytes).

Memory words are displayed in the Command Line component window.

E

The **E** command evaluates an expression and displays the result in the Command Line component window. When the expression is the only parameter entered (no option specified) the value of the expression is displayed in the default number base. The result is displayed as a signed number in decimal format and as unsigned number in all other formats.

Usage

```
E expression[;O|D|X|C|B]
```

where:

;O: displays the value of expression as an octal (base 8) number.

;D: displays the value of expression as a decimal (base 10) number.

;X: displays the value of expression as a hexadecimal (base 16) number.

;C: displays the value of expression as an ASCII character. The remainder resulting from dividing the number by 256 is displayed. All values are displayed in the current font. Control characters (<32) are displayed as decimal.

;B: displays the value of expression as a binary (base 2) number.

Components

Debugger engine.

Debugger Engine Commands

Debugger Commands

Example:

```
in>define a=0x12
in>define b=0x10
in>e a+b
in>=34
```

The addition operation of the two previously defined variables **a** and **b** is evaluated and the result is displayed in the Command Line window. The output can be redirected to a file by using the **LF** command (refer to [LF](#) and [LOG](#) command descriptions).

ELSE

The **ELSE** keyword is associated with the [LF](#) command.

Usage

```
ELSE
```

Components

Debugger engine.

Example:

```
if CUR_TARGET == 1000          /* Condition */
    set sim
else set bdi                    /* Other Condition */
```

ELSEIF

The **ELSEIF** keyword is associated with the [IF](#) command.

Usage

```
ELSEIF condition
where condition is same as defined in C language.
```

Components

Debugger engine.

Example:

```
if CUR_TARGET == 1000          /* Simulator */
    set sim
elseif CUR_TARGET == 1001 /* BDI */
    set bdi
```

ENDFOCUS

The **ENDFOCUS** command resets the current focus. It is associated with the **FOCUS** command. Following commands are broadcast to all currently open components. This command is only valid in a command file.

Usage

```
ENDFOCUS
```

Components

Debugger engine.

Example:

```
FOCUS Assembly
ATTRIBUTES code on
ENDFOCUS
FOCUS Source
ATTRIBUTES marks on
ENDFOCUS
```

The **ATTRIBUTES** command is first redirected to the Assembly component by the **FOCUS** Assembly command. The code is displayed next to assembly instructions. Then the Assembly component is released by the **ENDFOCUS** command and the second **ATTRIBUTES** command is redirected to the Source component by the **FOCUS** Source command. Marks are displayed in the Source window.

Debugger Engine Commands

Debugger Commands

ENDFOR

The **ENDFOR** keyword is associated with the [FOR](#) command.

Usage

```
ENDFOR
```

Components

Debugger engine.

Example:

```
for i = 1..5
    define multi5 = 5 * i
endfor
```

After the **ENDFOR** instruction, i is equal to 5.

ENDIF

The **ENDIF** keyword is associated with the [IF](#) command.

Usage

```
ENDIF
```

Components

Debugger engine.

Example:

```
if (CUR_CPU == 12)
    DW &counter
else
    DB &counter
endif
```

ENDWHILE

The **ENDWHILE** keyword is associated with the [WHILE](#) command.

Usage

```
ENDWHILE
```

Components

Debugger engine.

Example:

```
while i < 5
  define multi5 = 5 * i
  define i = i + 1
endwhile
```

After the **ENDWHILE** instruction, *i* is equal to 5

EXECUTE

In the Stimulation component, the **EXECUTE** command executes a file containing stimulation commands. Refer to the [I/O Stimulation](#) document.

Usage

```
EXECUTE fileName
```

Components

Stimulation component.

Example:

```
in>EXECUTE stimu.txt
```

Debugger Engine Commands

Debugger Commands

EXIT

In the Command line component, the **EXIT** command closes the Debugger application.

Usage

```
EXIT
```

Components

Debugger engine.

Example:

```
in>EXIT
```

The Debugger application is closed.

FILL

In the Memory component, the **FILL** command fills a corresponding range of Memory component with the defined value. The value must be a single byte pattern (higher bytes ignored).

Usage

```
FILL range value
```

The syntax for range is: `LowAddress...HighAddress`

Components

Memory component.

Equivalent Operation

The **Fill Memory** dialog box is available from the Memory context menu and by selecting *Fill* or *Memory > Fill* menu entry.

Example:

```
in>FILL 0x8000..0x8008 0xFF
```

The memory range 0x8000...0x8008 is filled with the value 0xFF.

FILTER

In the Memory component, with the **FILTER** command, you select what you want to display, for example **modules**: modules only, **functions**: modules and functions, or **lines**: modules and functions and code lines. You can also specify a range to be logged in your file. **Range** must be between 0 and 100.

Usage

```
FILTER Options [<range>]
Options = modules|functions|lines
```

Components

Coverage component.

Example:

```
in>coverage < FILTER functions 25..75
```

FIND

In the Source component, the **FIND** command is used to search a specified pattern in the source file currently loaded. If the pattern has been found, it is highlighted. The search is forward (default), backward (**;B**), match case sensitive (**;MC**) or match whole word sensitive (**;WW**). The operation starts from the currently highlighted statement or from the beginning of the file (if nothing is highlighted). If the item is found, the Source window is scrolled to the position of the item and the item is highlighted in gray.

Equivalent Operation

You can select *Source > Find* or open the Source context menu and select *Find* to open the **Find** dialog box.

Usage

```
FIND "string" [;B] [;MC] [;WW]
```

Where **string** is the "**pattern**" to match. It must be enclosed in double quotes. See the example below.

;B the search is backwards, default is forwards.

;MC match case sensitive is set.

Debugger Engine Commands

Debugger Commands

;WW match whole word is set.

Components

Source component.

Example:

```
in>FIND "this" ;B ;WW
```

The “**this**” string (considered as a whole word) is searched in the Source component window. The search is performed backward.

FINDPROC

If a valid procedure name is given as parameter, the source file where the procedure is defined is opened in the Source Component. The procedure’s definition is displayed and the procedure’s title is highlighted.

Equivalent Operation

You can select *Source > Find Procedure* or open the Source context menu and select *Find Procedure* to open the **Find Procedure** dialog box.

Usage

```
FINDPROC procedureName
```

Components

Source component.

Example:

```
in>findproc Fibonacci
```

The **Fibonacci** procedure is displayed and the title is highlighted.

FOCUS

The **FOCUS** command sets the given component (**component**) as the destination for all subsequent commands up to the next [ENDFOCUS](#) command. Hence, the focus command releases the user from repeatedly specifying the same command redirection, especially in the case where command files are edited manually. This command is only valid in a command file.

NOTE It is not possible to visually notice that a component is “FOCUSed”. However, you can use the [ACTIVATE](#) command to activate a component window.

Usage

```
FOCUS component
```

Components

Debugger engine.

Example:

```
FOCUS Assembly
ATTRIBUTES code on
ENDFOCUS
FOCUS Source
ATTRIBUTES marks on
ENDFOCUS
```

The **ATTRIBUTES** command is first redirected to the Assembly component by the **FOCUS Assembly** command. The code is displayed next to assembly instructions. Then the Assembly component is released by the **ENDFOCUS** command and the second **ATTRIBUTES** command is redirected to the Source component by the **FOCUS Source** command. Marks are displayed in the Source window.

Debugger Engine Commands

Debugger Commands

FOLD

In the Source component, the **FOLD** command hides the source text at the program block level. Folded program text is displayed as if the program block was empty. When the folded block is unfolded, the hidden program text reappears. All text is folded once or (*) completely, until there are no more folded parts.

Usage

```
FOLD [*]
```

Where * means fold completely, otherwise fold only one level.

Components

Source component.

Example:

```
in>FOLD *
```

FONT

FONT sets the font type, size and color.

Equivalent Operation

The **Font** dialog box is available by selecting the *Component > Fonts* menu entry.

Usage

```
FONT 'FontName' [size][color]
```

Components

Debugger engine.

Example:

```
FONT 'Arial' 8 BLUE
```

The font type is Arial, 8 points and blue.

FOR

The **FOR** loop allows you to execute all commands up to the trailing [ENDFOR](#) a predefined number of times. The bounds of the range and the optional steps are evaluated at the beginning. A **variable** (either a symbol or a program variable) may be optionally specified, which is assigned to all values of the range that are met during execution of the for loop. If a variable is used, it must be defined before executing the **FOR** command, with a [DEFINE](#) command.

Assignment happens immediately before comparing the iteration value with the upper bound. The variable is only a copy of the internal iteration value, therefore modifications on the variable don't have an impact on the number of iterations.

This command can be stopped by pressing the **Esc** key.

Usage

```
FOR[variable =]range [“,” step]
```

Where **variable** is the name of a defined variable.

range: This is an address range constant that specifies addresses to be disassembled.

step: constant number matching the step increment of the loop.

Components

Debugger engine.

Example:

```
DEFINE loop = 0  
FOR loop = 1..6,1  
T  
ENDFOR
```

The T Trace command is performed six times.

Debugger Engine Commands

Debugger Commands

FPRINTF

FPRINTF is the standard ANSI C command: Writes formatted output string to a file.

Usage

```
fprintf (<filename>, <&format>, <expression>,
        <expression>, ...)
```

Components

Debugger engine.

Example:

```
fprintf (test.txt, "%s %2d", "The value of the counter
is:", counter)
```

The content of the file `test.txt` is: The value of the counter is: 25

FRAMES

In the **SoftTrace component**, the **FRAMES** command sets the maximum number of frame records.

Usage

```
FRAMES number
```

Where **number** is a decimal number, which is the maximum number of recorded frames. This number must not exceed 1000000.

Components

SoftTrace component.

Example:

```
FRAMES 10000
```

G

The **G** command starts code execution in the emulated system at the current address in the program counter or at the specified address. You can therefore specify the entry point of your program, skipping execution of the previous code.

Usage

```
G [address]
```

When no **address** is entered, the address in the program counter is not altered and execution begins at the address in the program counter.

Alias

```
GO
```

Components

Debugger engine.

Example:

```
G 0x8000
```

Program execution is started at 0x8000. **RUNNING** is displayed in the status bar. The application runs until a breakpoint is reached or you stop the execution.

GO

The **GO** command starts code execution in the emulated system at the current address in the program counter or at the specified address. You can therefore specify the entry point of your program, skipping execution of previous code.

Usage

```
GO [address]
```

When no **address** is entered, the address in the program counter is not altered and execution begins at the address in the program counter.

Alias

```
G
```

Debugger Engine Commands

Debugger Commands

Components

Debugger engine.

Example:

```
in>GO 0x8000
```

Program execution is started at address 0x8000. **RUNNING** is displayed in the status bar. The application runs until a breakpoint is reached or you stop execution.

GOTO

The **GOTO** command diverts execution of the command file to the command line that follows the Label. The Label must be defined in the current command file. The **GOTO** command fails, if the Label is not found. A label can only be followed on the same line by a comment.

Usage

```
GOTO Label
```

Components

Debugger engine.

Example:

```
GOTO MyLabel
```

```
...  
...
```

```
MyLabel: // comments
```

When the instruction `GOTO MyLabel` is reached, the program pointer jumps to `MyLabel` and follows program execution from this position.

GOTOIF

The **GOTOIF** command diverts execution of the command file to the command line that follows the label if the condition is true. Otherwise, the command is ignored. The **GOTOIF** command fails, if the condition is true and the label is not found.

Usage

```
GOTOIF condition Label
```

where condition is same as defined in “C” language.

Components

Debugger engine.

Example:

```
DEFINE jump = 0
...
DEFINE jump = jump + 1
...
GOTOIF jump == 10 MyLabel
T
...
MyLabel: // comments
```

The program pointer jumps to MyLabel only if jump equals 10. Otherwise, the next instruction (T Trace command) is executed.

GRAPHICS

In the Profiler component, **GRAPHICS** switches the percentages display in the graph bar **on/off**.

Usage

```
GRAPHICS on|off
```

Components

Profiler component.

Debugger Engine Commands

Debugger Commands

Example:

```
in>GRAPHICS off
```

HELP

In the Command line component, the **HELP** command displays all available commands.

Subcommands from the **ATTRIBUTES** command are not listed.

Component specific commands, which are not open, are not listed.

Usage

```
HELP
```

Components

Debugger engine.

Example:

```
in>HELP
HI-WAVE Engine:
  VER
  LF
  NOLF
  CR
  NOCR
  . . . .
```

IF

The conditional commands ([IF](#), [ELSEIF](#), [ELSE](#) and [ENDIF](#)) allow you to execute different sections depending on the result of the corresponding condition. The conditional command may be nested. Conditions of the **IF** and **ELSEIF** commands, respectively, guard all commands up to the next **ELSEIF**, **ELSE** or **ENDIF** command on the same nesting level. The **ELSE** command guards all commands up to the next **ENDIF** command on the same nesting level. Any occurrence of a subcommand not in sequence of “**IF**, zero or more **ELSEIF**, zero or one **ELSE**, **ENDIF**” is an error.

Usage

```
IF condition
```

Where **condition** is same as defined in “C” language.

Components

Debugger engine.

Example:

```
DEFINE jump = 0
...
DEFINE jump = jump + 1
...
IF jump == 10
    T
    DEFINE jump = 0
ELSEIF jump == 100
    DEFINE jump = 1
ELSE
    DEFINE jump = 2
ENDIF
```

The `jump == 10` condition is evaluated and depending on the test result, the T Trace instruction is executed, or the `ELSEIF jump == 100` test is evaluated.

INSPECTOROUTPUT

The Inspector dumps the content of the specified item and all computed subitems to the command window. Uncomputed subitems are not printed. To compute all information, the **ATTRIBUTES EXPAND** command is used.

Usage

```
INSPECTOROUTPUT [name {subname}]
```

The **name** specifies any of the root items. The **subname** specifies a recursive path to subitems.

If a name contains a space, it must be surrounded by double quotes (“”).

Debugger Engine Commands

Debugger Commands

Components

Inspector component.

Example:

```
in>loadio swap
in>Inspect<ATTRIBUTES EXPAND 3
in>INSPECTOROUTPUT "Object Pool" Swap

Swap
* Name      Value  Address  Init...
- IO_Reg_1  0x0   0x1000  0x0 ...
- IO_Reg_2  0x0   0x1001  0x0 ...
```

INSPECTORUPDATE

The Inspector displays various information. Some types of information are automatically updated. To make sure that displayed values correspond to the current situation, the **INSPECTORUPDATE** command updates all information.

Usage

```
INSPECTORUPDATE
```

Components

Inspector component.

Example:

```
in>INSPECTORUPDATE
```

LF

The **LF** command initiates logging of commands and responses to an external file or device. While logging remains in effect, any line that is appended to the command window is also written to the log file.

Logging continues until a close log file (**NOLE**) command is executed. When the **LF** command is entered with no filename, the Open File dialog box is displayed to specify a filename.

Use the logging option (**LOG**) command to specify information to be logged.

If a path is specified in the file name, this path must be a valid path. When a relative path is specified, ensure that the path is relative to the project directory.

Usage

```
LF [fileName] [;A]
```

fileName is a DOS filename that identifies the file or device where the log is written. The command interpreter does not assume a filename extension.

;A opens the file in append mode. Logged lines are appended at the end of an existing log file.

If the **;A** option is omitted and **fileName** is an existing file, the file is cleared before logging begins.

Components

Debugger engine.

Example

```
in>lf /mcuez/demo/logfile.txt ;A
```

The logfile.txt file is opened as a Log File in “append” mode.

NOTE If no path is specified, the destination directory is the current project directory.

Debugger Engine Commands

Debugger Commands

LOAD

The **LOAD** command loads a framework application (.abs file) for a debugging session. When no application name is specified, the **LoadObjectFile** dialog box is opened.

If no target is installed, the following error message appears:

Error: no target is installed

If no target is connected, the following error message appears:

Error: no target is connected

Usage

```
LOAD[applicationName] [CODEONLY|SYMBOLSONLY]
[NOPROGRESSBAR] [NOBPT] [NOXPR] [NOPRELOADCMD]
[NOPOSTLOADCMD] [VERIFYFIRST|VERIFYALL|VERIFYONLY]
[AUTOERASEANDFLASH] [NORUNAFTERLOAD|RUNANDSTOPAFTERLOAD
= functionName|RUNAFTERLOAD] [DELAY] [ADD_SYMBOLS]
```

Where:

- **applicationName** is the name of the application to load
- **CODEONLY** and **SYMBOLSONLY** loads only the code or symbols
- **NOPROGRESSBAR** loads the application without progress bar
- **NOBPT** loads the application without loading breakpoints file (with BPT extension)
- **NOXPR** loads the application without playing Expression file (with XPR extension)
- **NOPRELOADCMD** loads the application without playing PRELOAD file
- **NOPOSTLOADCMD** loads the application without playing POSTLOAD file
- **DELAY** loads the application and waits one second
- **VERIFYFIRST** matches the "First bytes only" code verification option.
- **VERIFYALL** matches the "All bytes" code verification option.
- **VERIFYONLY** matches the "Read back only" code verification option.
- **RUNAFTERLOAD** runs application after loading
- **RUNANDSTOPAFTERLOAD** runs application after loading and set temporary breakpoint at the specified function
- **functionName** is the name of the function to set temporary breakpoint at
- **NORUNAFTERLOAD** doesn't run application after loading (default)

- **ADD_SYMBOLS** appends the symbol information to the existing symbol table instead of replacing it

NOTE By default, the `LOAD` command is “code+symbols” with no verification.

NOTE If the `ADD_SYMBOLS` parameter is passed, `PRELOAD` and `POSTLOAD` files play for the first loaded application only.

Components

Debugger engine.

Example:

```
LOAD FIBO.ABS
```

The `FIBO.ABS` application is loaded.

NOTE If no path is specified, the destination directory is the current project directory.

LOADCODE

This command loads code into the target system. This command can be used if no debugging is needed. If no target is installed, the following error message is displayed:

“Error: no target is installed”

If no target is connected, the following error message is displayed:

“Error: no target is connected”

Usage

```
LOADCODE [applicationName]
```

Components

Debugger engine.

Example:

```
LOADCODE FIBO.ABS
```

Code of the `FIBO.ABS` application is loaded.

NOTE If no path is specified, the destination directory is the current project directory.

Debugger Engine Commands

Debugger Commands

LOADSYMBOLS

This command is similar to the **LOAD** command but only loads debugging information into the debugger. This can be used if the code is already loaded into the target system or programmed into a non-volatile memory device.

If no target is installed, the following error message is displayed:

“Error: no target is installed”

If no target is connected, the following error message is displayed:

“Error: no target is connected”

Usage

```
LOADSYMBOLS [applicationName]
```

Components

Debugger engine.

Example:

```
LOADSYMBOLS FIBO.ABS
```

Debugging information of the FIBO.ABS application is loaded. If no path is specified, the destination directory is the current project directory.

LOG

The **LOG** command enables or disables logging of information in the Command Line component window (and to logfile, when it has been opened with an **LF** command). If **LOG** is not used, all types are **ON** by default i.e. all information is logged in the Command Line component and log file.

NOTE **RESPONSES:** Responses are results of commands. For example, for the DB command, the displayed memory dump is the response of the command. Protocol messages are not responses.

ERRORS: Errors are displayed in red in Command Line component. Protocol messages are not errors.

NOTICES: Notices are displayed in green in the Command Line.

Usage

```
LOG type [=] state {[,] type [=] state}
```

Where **type** is one of the following types:

CMDLINE: Commands entered on the command line.

CMDFILE: Commands read from a file.

RESPONSES: Command output response.

ERRORS: Error messages.

NOTICES: Asynchronous event notices, such as breakpoints.

Where **state** is **on** or **off**.

state is the new state of **type**:

- When **ON**, enables logging of the type.
- When **OFF**, disables logging of the **type**.

Components

Debugger engine.

Example:

```
LOG ERRORS = OFF, CMDLINE = on
```

Error messages are not recorded in the Log File. Commands entered in the Command Line component window are recorded.

More About Logging of IF, FOR, WHILE and REPEAT

When commands executed from a command file are logged, all executed commands that are in a **IF** block are logged. That is, a command file executed with the **CF** or **CALL** command without the **NL** option and with **CMDFILE** flag of the **LOG** command set to **TRUE**. All commands in a block that are not executed because the corresponding condition is false are also logged but preceded with a “-”.

Example 1:

When executing the following command file:

```
define truth = 1
IF truth
    bckcolor blue
    at 2000 bckcolor white
else
```

Debugger Engine Commands

Debugger Commands

```

    bckcolor yellow
    at 1000 bckcolor white
ENDIF

```

The following log file is generated:

```

!define truth = 1
!IF truth
!  bckcolor blue
!  at 2000 bckcolor white
!else
!-  bckcolor yellow
!-  at 1000 bckcolor white
!ENDIF

```

When commands executed from a command file are logged, all executed commands that are in the **FOR** loop are logged the number of times they have been executed. That is, a command file executed with the **CF** or **CALL** command without the **NL** option and with the **CMDFILE** flag of the **LOG** command set to **TRUE**.

Example 2:

When executing the following file:

```

define i = 1
FOR i = 1..3
    ls
ENDFOR

```

The following log file is generated:

```

!define i = 1
!FOR i = 1..3
!  ls
i          0x1 (1)
!ENDFOR
!  ls
i          0x2 (2)
!ENDFOR
!  ls

```



```
i                0x3 (3)
!ENDFOR
```

When commands executed from a command file are logged, all executed commands that are in the **WHILE** loop are logged the number of times they have been executed. That is, a command file executed with the **CF** or **CALL** command without the **NL** option and with the **CMDFILE** flag of the **LOG** command set to **TRUE**.

Example 3:

When executing the following file:

```
define i = 1
WHILE i < 3
    define i = i + 1
ls
ENDWHILE
```

The following log file is generated:

```
!define i = 1
!WHILE i < 3
!    define i = i + 1
! ls
i                0x2 (2)
!ENDWHILE
!    define i = i + 1
! ls
i                0x3 (3)
!ENDWHILE
```

When commands executed from a command file are logged, all executed commands that are in the **REPEAT** loop are logged the number of times they have been executed. That is, a command file executed with the **CF** or **CALL** command without the **NL** option and with the **CMDFILE** flag of the **LOG** command set to **TRUE**.

Debugger Engine Commands

Debugger Commands

Example 4:

When executing the following file:

```
define i = 1
REPEAT
    define i = i + 1
ls
UNTIL i == 4
```

The following log file is generated:

```
repeat
until condition
!define i = 1
!REPEAT
!   define i = i + 1
! ls
i           0x2 (2)
!UNTIL i == 4
!   define i = i + 1
! ls
i           0x3 (3)
!UNTIL i == 4
!   define i = i + 1
! ls
i           0x4 (4)
!UNTIL i == 4
```

LS

In the Command Line window, the **LS** command lists the values of symbols defined in the symbol table and by the user. There is no limit to the number of symbols that can be listed. The size of memory determines the symbol table size. Use the [DEFINE](#) command to define symbols, and the [UNDEF](#) command to delete symbols.

The symbols that are listed with the LS command are split in two parts: Applications Symbols and User Symbols.

Usage

```
LS [symbol | *] [;C|S]
```

Where **symbol** is a restricted regular expression that specifies the symbol whose values are to be listed.

* specifies to list all symbols.

;C specifies to list symbols in canonical format, which consists of a DEFINE command for each symbol.

;S specifies to list symbol table statistics following the list of symbols.

Components

Debugger engine.

Example:

```
in>ls
User Symbols:
j                0x2 (2)
Application Symbols:
counter         0x80 (128)
fibonacciCount 0x81 (129)
j              0x83 (131)
n              0x84 (132)
fib1          0x85 (133)
fib2          0x87 (135)
fibonacci     0x89 (137)
Fibonacci     0xF000 (61440)
Entry         0xF041 (61505)
```

Debugger Engine Commands

Debugger Commands

When LS is performed on a single symbol (e.g., **in>ls counter**) that is an application variable as well as a user symbol, the application variable is displayed.

Example with **j** being an application symbol as well as a user symbol:

```
in>ls j
Application Symbol:
j                0x83 (131)
```

MEM

The **MEM** command displays a representation of the current system memory map and lower and upper boundaries of the internal module that contains the MCU registers.

Usage

```
MEM
```

Components

Debugger engine.

Example:

```
in>mem
Type      Addresses  Comment
-----
IO        0.. 3F  PRU or TOP  TOP board resource or the PRU
NONE     40.. 4F  NONE
RAM       50.. 64F  RAM
NONE     650.. 7FF  NONE
EEPROM   800.. A7F  EEPROM
NONE    A80..3DFF  NONE
ROM      3E00..FDFF  ROM
IO      FE00..FE1F  PRU or TOP  TOP board resource or the PRU
NONE    FE20..FFDB  NONE
ROM     FFDC..FFFE  ROM
COP     FFFF..FFFF  special ram for cop
RT MEM   0.. 3FF  (enabled)
-----
```

MS

The **MS** command sets a specified block of memory to a specified list of byte values. When the **range** is wider than the **list** of byte values, the **list** of byte values is repeated as many times as necessary to fill the memory block.

When the **range** is not an integer multiple of the length of the **list**, the last copy of the **list** is truncated appropriately. This command is identical to the write bytes ([WB](#)) command.

Usage

```
MS range list
```

range: is an address range constant that defines the block of memory to be set to the values of the bytes in the list.

list: is a list of byte values to be stored in the block of memory.

Components

- Debugger engine.

Example:

```
in>MS 0x1000..0x100F 0xFF
```

The memory range between addresses 0x1000 and 0x100F is filled with the 0xFF value.

NB

Description

The NB command changes or displays the default number base for the constant values in expressions. The initial default number base is 10 (decimal) and can be changed to 16 (hexadecimal), 8 (octal), 2 (binary) or reset to 10 with this command. The base is always specified as a decimal constant.

Independent of the default base number, the ANSI C standard notation for constant is supported inside an expression. That means that independent of the current number base you can specify hexadecimal or octal constants using the standard ANSI C notation shown in [Table 34.6](#).

Debugger Engine Commands

Debugger Commands

Usage

NB [base]

Where **base** is the new number base (2, 8, 10 or 16).

Components

Debugger engine.

Table 34.6 ANSI C Constant Notation

Notation	Meaning
0x----	Hexadecimal constant
0----	Octal constant

Table Example:

```
0x2F00, /* Hexadecimal Constant */
043,    /* Octal Constant */
255     /* Decimal Constant */
```

In the same way, the **Assembler** notation for constant is also supported. That means that independent of the current number base you can specify hexadecimal, octal or binary constants using the **Assembler** prefixes shown in [Table 34.7](#).

Table 34.7 Assembler Notation for Constant

Notation	Meaning
\$----	Hexadecimal constant
@----	Octal constant
%----	Binary constant

Table Example:

```
$2F00, /* Hexadecimal Constant */
@43,   /* Octal Constant */
%10011 /* Binary Constant */
```

When the default number base is 16, constants starting with a letter A, B, C, D, E or F must be prefixed either by 0x or by \$, as shown in [Table 34.8](#). Otherwise, the command line interpreter cannot detect if you are specifying a number or a symbol.

Table 34.8 Base is 16: Constants Starting with Letter A, B, C, D, E or F

Notation	Meaning
5AFD	Hexadecimal constant \$5AFD
AFD	Hexadecimal constant \$AFD

Table Example:

```
in>NB 16
The number base is hexadecimal.
```

NOCR

The **NOCR** command closes the current record file. The record file is opened with the [CR](#) command.

Usage

```
NOCR
```

Components

Debugger engine.

Example:

```
in>NOCR
The current record file is closed.
```

NOLF

The **NOLF** command closes the current Log File. The log file is opened with the [LF](#) command.

Usage

```
NOLF
```

Debugger Engine Commands

Debugger Commands

Components

Debugger engine.

Example:

```
in>NOLF
```

The current Log File is closed.

OPEN

The **OPEN** command is used to open a window component.

Usage

```
OPEN "component" [x y width height] [;I | ;MAX]
```

where:

- **component** is the component name with an optional path
- **x** is the X-axis of the upper left corner of the window component
- **y** is the Y-axis of the upper left corner of the window component
- **width** is the width of the window component
- **height** the height of the window component

When **I** is specified, the component window displays icons; when **MAX** is specified, the component window is maximized.

Component names are: Assembly, Command, Coverage, Data, Inspect, IO_Led, Led, Memory, Module, Phone, Procedure, Profiler, Recorder, Register, SoftTrace, Source, Stimulation.

Components

Debugger engine.

Example:

```
in>OPEN Terminal 0 78 60 22
```

The Terminal component and window is opened at specified positions and with specified width and height.

OUTPUT

With **OUTPUT**, you can redirect the Coverage component results to an output file indicated by the path and file name.

Usage

```
OUTPUT FileName
```

Where FileName is file name (path + name).

Components

Coverage component.

Example:

```
in>coverage < OUTPUT c:\Program  
Files\Freescale\myfile.txt
```

The Coverage output results are redirected to the file `myfile.txt` from the directory `C:\Program Files\Freescale`.

P

The **P** command executes a CPU instruction, either at a specified address or at the current instruction, (pointed to by the program counter). This command traces through subroutine calls, software interrupts, and operations involving the following instructions (two are target specific):

- Branch to SubRoutine (**BSR**)
- Long Branch to Subroutine (**LBSR**)
- Jump to Subroutine (**JSR**)
- Software Interrupt (**SWI**)
- Repeat Multiply and Accumulate (**RMAC**)

For example: if the current instruction is a **BSR** instruction, the subroutine is executed, and execution stops at the first instruction after the **BSR** instruction. For instructions that are not in the above list, the **P** and **T** commands are equivalent.

When the instruction specified in the **P** command has been executed, the software displays the content of the CPU registers, the instruction bytes at the new value of the program counter and a mnemonic disassembly of that instruction.

Debugger Engine Commands

Debugger Commands

Usage

P [address]

address: is an address constant expression, the address at which execution begins.

If **address** is omitted, execution begins with the instruction pointed to by the current value of the program counter.

Components

Debugger engine.

Example:

```
in>p
```

```
A=0x0 HX=0x450 SR=0x70 PC=0xF04E SP=0xFF
```

```
00F04E 94 TXS
```

```
STEPPED
```

Contents of registers are displayed and the current instruction is disassembled.

PAUSETEST

Displays a modal message box, shown in [Figure 34.1](#), for testing purposes.

Figure 34.1 Test Pause Message Box

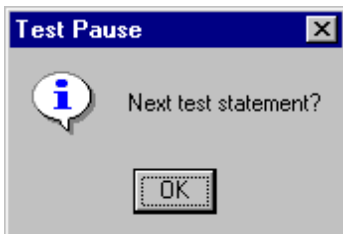

Usage

PAUSETEST

Components

Debugger engine.

Example:

```
in> pausetest
```

PRINTF

The **PRINTF** is the standard ANSI C command: Prints formatted output to the standard output stream.

Usage

```
PRINTF (" [Text ]%format specification" , value)
```

Components

Debugger engine.

Example

```
in>PRINTF("The value of the counter is: %d", counter)
```

The output is: The value of the counter is: 2

PTRARRAY

The **PTRARRAY** command allows the user to specify a pointer to display as an array.

Usage

```
PTRARRAY on|off [nb]
```

Where:

- **on** displays pointers as arrays.
- **off** displays pointers as usual (*pointer).
- **nb** is the number of elements to display in the array when unfolding a pointer displayed as array.

Components

Data component.

Example:

```
in>Ptrarray on 5
```

Display content of pointers as array of five items.

Debugger Engine Commands

Debugger Commands

RD

The **RD** command displays the content of specified registers. The display of a register includes both the name and hexadecimal representation. If the specified register is not a CPU register, then it looks for this register in a register file as an I/O register. This file is called: **MCUIxxx.REG** (where **xxx** is a number related to the MCU).

NOTE This command is processor/derivative specific and does not display banked registers if the processor does not support banking.

Usage

```
RD { <list> | CPU | * }
```

where **list** is a list of registers to be displayed. Registers to be displayed are separated by a space. When **RD CPU** is specified, all CPU registers are displayed. If no CPU is loaded, **No CPU loaded** is displayed as an error message.

When ***** is specified, the **RD** command lists the content of the register file that is currently loaded. If no register file is loaded, following error message is displayed: **No register file loaded**.

When there is no parameter, the previous **RD** command is processed again. If there is no previous **RD** command, all CPU registers are displayed.

If **list** is omitted, the list and any other parameters of the previous **RD** command are used.

For the first **RD** command of a session, all CPU registers are displayed.

Components

Debugger engine.

Example 1:

```
in>rd a hx
A=0x14
HX=0x2
```

Example 2:

```
in>rd cpu
A=0x0 HX=0x450 SR=0x70 PC=0xF04E SP=0xFF
```

RECORD

In the **SoftTrace component**, the **RECORD** command switches frame recording **on / off** while the target is running.

Usage

```
RECORD on|off
```

Components

SoftTrace component.

Example:

```
in>RECORD on
```

REPEAT

The **REPEAT** command allows you to execute a sequence of commands until a specified condition is true. The **REPEAT** command may be nested.

Press the **Esc** key to stop this command.

Usage

```
REPEAT
```

Components

Debugger engine.

Example:

```
DEFINE var = 0
...
REPEAT
    DEFINE var = var + 1
    ...
UNTIL var == 2
```

The **REPEAT-UNTIL** loop is identical to the ANSI C loop. The operation **DEFINE var = var + 1** is done twice, then **var == 2** and the loop ends.

Debugger Engine Commands

Debugger Commands

RESET

In the **Profiler and Coverage component**, the **RESET** command resets all recorded frames (statistics).

In the **SoftTrace component**, the **RESET** command resets statistics and recorded frames.

NOTE Make sure that the **RESET** command is redirected to the correct component. Targets also have their own **RESET** command and if **RESET** is not redirected, the target is reset.

Usage

```
RESET
```

Components

Profiler and Coverage.

Example:

```
in>Profiler < RESET
```

RESTART

Resets execution to the first line of the current application and executes the application from this point.

Usage

```
RESTART
```

Components

Engine component.

Example

```
in>RESTART
```

After the **RESTART** command, the cycle counter is initialized to zero.

RETURN

The **RETURN** command terminates the current command processing level (returns from a [CALL](#) command). If executed within a command file, control is returned to the caller of the command file (i.e. the first instance that did not chain execution).

Usage

```
RETURN
```

Components

Debugger engine.

Example:

```
In file d:\demo\cmd1.txt:
...
CALL d:\demo\cmd2.txt
T
...
In file d:\demo\cmd2.txt
...
...
RETURN // returns to the caller
```

The command file `cmd1.txt` calls a second command file `cmd2.txt`. It is so necessary to insert the **RETURN** instruction to return to the caller file. Then the **T** Trace instruction is executed.

RS

The **RS** command assigns new values to specified registers. The **RS** mnemonic is followed by register name and new value(s).

An equal sign (=) may be used to separate the register name from the value to be assigned to the register; otherwise they must be separated by a space. The contents of any number of registers may be set using a single **RS** command. If the specified register is not a CPU register, then the register is searched in a register file as an I/O register. This file is called: `MCUIxxxx.REG` (where `xxxx` is a number related to the MCU).

Debugger Engine Commands

Debugger Commands

Usage

```
RS register[=]value{, register[=]value}
```

register: Specifies the name of a register to be changed. String register is any of the CPU register names, or name of a register in the register file.

value: is an integer constant expression (in ANSI format representation).

Components

Debugger engine.

Example:

```
in>rs a=0xff hx=0x7fff
```

S

The **S** command stops execution of the emulation processor. Use the Go **G** command to start the emulator.

NOTE The S command ends as soon as the PC is changed.

Usage

```
S
```

Alias

```
STOP
```

Components

Debugger engine.

Example:

```
in>s
```

```
STOPPING
```

```
HALTED
```

Current application debugging is stopped/halted.

SAVE

The **SAVE** command saves a specified block of memory to a specified file in Freescale S-record format. The memory block can be reloaded later using the load S-record ([SREC](#)) command.

NOTE If no path is specified, the destination directory is the current project directory.

Usage

```
SAVE range fileName [offset] [;A]
```

offset: an optional offset to add or subtract from addresses when writing S-records. The default offset is **0**.

;A: appends the saved S-records to the end of an existing file. If this option is omitted, and the file specified by fileName exists, the file is cleared before saving the S-records.

Components

Debugger engine.

Example:

```
in>SAVE 0x1000..0x2000 DUMP.SX ;A
```

The memory range 0x1000...0x2000 is appended to the DUMP .SX file.

SAVEBP

The **SAVEBP** command saves all breakpoints of the currently loaded .ABS file into the matching breakpoints file. Also, the matching file has the name of the loaded .ABS file but its extension is .BPT. (For example, the Fib0 .ABS file has a breakpoint file called FIB0 .BPT. This file is generated in the same directory as the .ABS file, when the user quits the Simulator/Debugger or loads another .ABS file.)

If on is set, SAVEBP stores all breakpoints defined in the current application in the matching .BPT file.

If off is set, SAVEBP does not store all breakpoints defined in the current application in the matching .BPT file.

This command is only used in .BPT files and is related to the checkbox **Save & Restore on load** in the Controlpoints Configuration Window. It is used to store currently defined

Debugger Engine Commands

Debugger Commands

breakpoints (**SAVEBP** on) when the user quits the Simulator/Debugger or loads another .ABS file.

NOTE For more information about this syntax, refer to [BS](#) command and to the [Control Points](#) chapter.

Usage

SAVEBP on|off

Components

Debugger engine.

Example:

Content of the FIBO.BPT file

```
savebp on
```

```
BS &fibonacci:Fibonacci+19 P E; cond = "fibonacci > 10" E; cdSz = 47 srSz = 0
```

```
BS &fibonacci:Fibonacci+31 P E; cdSz = 47 srSz = 0
```

```
BS &fibonacci:main+12 P E; cdSz = 42 srSz = 0
```

```
BS &fibonacci:main+21 P E; cond = "fibonacciCount==5" E; cmd = "Assembly < spc 0x800" E; cdSz = 42 srSz = 0
```

SET

Sets a new current target for the debugger by loading the targetName component.

Usage

```
SET targetName
```

where targetName is name without extension of the target to set.

Components

Debugger engine.

Example:

```
in>SET Sim
```

The debugger's current target is Simulator.

SETCOLORS

The **SETCOLORS** command is used to change the colors for a specific channel from the Monitor component.

Usage

```
SETCOLORS ( "Name" ) ( Background ) ( Cursor ) ( Grid )  
( Line ) ( Text )
```

Name is the name of the channel to modify.

Background is the new color for the channel background (the format is: 0x00bbgrr).

Cursor is the new color for the channel cursor (the format is: 0x00bbgrr).

Grid is the new color for the channel grid (the format is: 0x00bbgrr).

Line is the new color for the channel lines (the format is: 0x00bbgrr).

Text is the new color for the channel text (the format is: 0x00bbgrr).

Components

Monitor component.

Example:

```
in>SETCOLORS "Leds.Port_Register bit 0" 0x00123456  
0x00234567 0x00345678 0x00456789 0x00567891
```

This changes the color attributes from the channel Leds.Port_Register bit 0 to the new values.

SLAY

The **SLAY** command is used to save the layout of all window components in the main application window to a specified file.

NOTE Layout files usually have a .HWL extension. However, you can specify any file extension.

NOTE If no path is specified, the destination directory is the current project directory.

Debugger Engine Commands

Debugger Commands

Usage

`SLAY fileName`

Components

Debugger engine.

Example:

```
in>slay /hiwave/demo/mylayout.hwl
```

The current debugger layout is saved to the `mylayout.hwl` file in the `/hiwave/demo` directory.

SLINE

With the **SLINE** command, a line of the source file is made visible. If the line is not currently visible, the source scrolls so that it appears on the first line. If the line is currently in a folded part, it is unfolded so that it becomes visible.

NOTE The given line number must be between 1 and number of lines in source file, or else an error message is displayed.

Usage

`SLINE line number`

Components

Source component

Example:

```
in>sline 15
```

SMEM

In the **Source component**, the **SMEM** command loads the corresponding module's source text, scrolls to the corresponding text location (the code address) and highlights the statements that correspond to this code address range.

In the **Assembly component**, the **SMEM** command scrolls the Assembly component, shows the location (the assembler address) and select/highlights the memory lines of the address range given as the parameter.

In the **Memory component**, the **SMEM** command scrolls the memory dump component, shows the locations (the memory address) of the address range given as the parameter.

Usage

```
SMEM range
```

Components

Source, Assembly and Memory components.

Example:

```
in>Memory < SMEM 0x8000,8
```

The Memory component window is scrolled and specified memory addresses are highlighted.

SMOD

In the **Source component**, the **SMOD** command loads/displays the corresponding module's source text. If the module is not found, a message is displayed in Command Line window.

In the **Data component**, the **SMOD** command loads the corresponding module's global variables.

In the **Memory component**, the **SMOD** command scrolls the memory dump component and highlights the first global variable of the module.

NOTE Correct module names are displayed in the Module component window. Make sure that the module name of your command is correct. If the **.abs** is in **HIWARE** format, some debug information is in the object file (**.o**), and module names have a **.o** extension (e.g., **fib.o**). In **ELF** format, module name extensions are **.c**, **.cpp** or **.dbg** (**.dbg** or program sources in

Debugger Engine Commands

Debugger Commands

assembler) (e.g., `fibonacci.c`), since all debugging information is contained in the `.abs` file and object files are not used. Adapt the following examples with your `.abs` application file format.

Usage

`SMOD module`

Where **module** is the name of a module taking part of the application. Do not include a path in the module name. The module extension (i.e., `.DBG` for assembly sources or `.C` for C sources) must be specified.

The module name is searched in the directories associated with the **GENPATH** environment variable. An error message is displayed:

- If the module specified does not take part of the current application loaded.
- If no application is loaded.

Components

Data, Memory and source components.

Example:

```
in>Data:1 < SMOD fibonacci.c
```

Global variables found in the `fibonacci.c` module are displayed in the Data:1 component window.

SPC

In the **Source component**, the **SPC** command loads the corresponding module's source text, scrolls to the corresponding text location (the code address) and highlights the statement that corresponds to this code address.

In the **Assembler component**, the **SPC** command scrolls the Assembly component, shows the location (the assembler address) and select/highlights the assembler instruction of the address given as parameter.

In the **Memory component**, the **SPC** command scrolls the memory dump component, shows the location (the memory address) of the address given as parameter.

Usage

`SPC address`

Components

Assembler, Memory and Source component.

Example:

```
in>Assembly < SPC 0x8000
```

The Assembly component window is scrolled to the address **0x8000** and the associated instruction is highlighted.

SPROC

In the **Data component**, the **SPROC** command shows local variables of the corresponding procedure stack level.

In the **Source component**, the **SPROC** command loads the corresponding module's source text, scrolls to the corresponding procedure and highlights the statement of this procedure that is in the procedure chain.

level = 0 is the current procedure level. **level = 1** is the caller stack level and so on.

NOTE This command is relevant when "C-source" debugging.

NOTE When a procedure of a level greater than 0 is given as parameter to the **SPROC** command, the statement corresponding to the call of the lower procedure is selected.

Usage

`SPROC level`

Components

Data and Source components.

Example:

```
in>Source < SPROC 1
```

This command displays the source code associated with the caller function in the Source component window.

Debugger Engine Commands

Debugger Commands

SREC

The **SREC** command initiates the loading of Freescale S-Records from a specified file.

NOTE If no path is specified, the destination directory is the current project directory.

Usage

```
SREC fileName [offset]
```

offset: is a signed value added to the load addresses in the file when loading the file contents.

Components

Debugger engine.

Example:

```
in>SREC DUMP.SX
```

The DUMP.SX file is loaded into memory.

STEPINTO

The **STEPINTO** command single-steps through instructions in the program, and enters each function call that is encountered.

NOTE This command works while the application is paused in break mode (program is waiting for user input after completing a debugging command).

Usage

```
STEPINTO
```

Components

Debugger engine.

Example:

```
in>STEPINTO
STEP INTO
TRACED
```

TRACED in the status line indicates that the application is stopped by an assembly step function.

STEPOUT

The **STEPOUT** command executes the remaining lines of a function in which the current execution point lies. The next statement displayed is the statement following the procedure call. All of the code is executed between the current and final execution points. Using this command, you can quickly finish executing the current function after determining that a bug is not present in the function.

NOTE This command works while the application is paused in break mode (program is waiting for user input after completing a debugging command).

Usage

```
STEPOUT
```

Components

Debugger engine.

Example:

```
in>STEPOUT
STEP OUT
STARTED
RUNNING
STOPPED
```

STOPPED in the status line indicates that the application is stopped by a step out function.

Debugger Engine Commands

Debugger Commands

STEPOVER

The **STEPOVER** command executes the procedure as a unit, and then steps to the next statement in the current procedure. Therefore, the next statement displayed is the next statement in the current procedure regardless of whether the current statement is a call to another procedure.

NOTE This command works while the application is paused in break mode (program is waiting for user input after completing a debugging command).

Usage

STEPOVER

Components

Debugger engine.

Example:

```
in>STEPOVER
STEP OVER
STARTED
RUNNING
STOPPED
```

STEPPED OVER (or STOPPED) in the status line indicates that the application is stopped by a step over function.

STOP

The **STOP** command stops execution of the emulation processor. Use the Go **G** command to start the emulator.

NOTE The **STOP** command ends as soon as the PC is changed.

Usage

STOP

Alias

S

Components

Debugger engine.

Example:

```
in>STOP
STOPPING
HALTED
Current application debugging is stopped.
```

T

The **T** command executes one or more instructions at a specified address, or at the current address (the address in the program counter). The **T** command traces into subroutine calls and software interrupts. For example, if the current instruction is a Branch to Subroutine instruction (**BSR**), the **BSR** is traced, and execution stops at the first instruction of the subroutine. After executing the last (or only) instruction, the **T** command displays the contents of the CPU registers, the instruction bytes at the new address in the program counter and a mnemonic disassembly of the current instruction.

This command can be stopped by typing the **Esc** key.

Debugger Engine Commands

Debugger Commands

Usage

T [address] [, count]

address: is an address constant expression, the address where execution begins. If **address** is omitted, the instruction pointed to by the current value of the program counter is the first instruction traced.

count: is an integer constant expression, in the decimal integral interval [1, 65535], that specifies the number of instructions to be traced. If **count** is omitted, one instruction is traced.

Components

Debugger engine.

Example:

```
in>T 0xF030
```

```
TRACED
```

```
A=0x0 HX=0x7F02 SR=0x62 PC=0xF032 SP=0x44D
```

```
00F032 B787          STA    0x87
```

Contents of registers are displayed and current instruction is disassembled.

TESTBOX

Displays a modal message box shown in [Figure 34.2](#) with a given string.

Figure 34.2 Test Box Message Box



Usage

```
TESTBOX "<String>"
```

Components

Debugger engine.

Example:

```
in>TESTBOX "Step 1: init all vars"
```

TUPDATE

In **Profiler and Coverage components**, the **TUPDATE** command switches the time update feature **on/off**.

Usage

```
TUPDATE on|off
```

Components

Profiler and Coverage components.

Example:

```
in>TUPDATE on
```

UNDEF

The **UNDEF** command removes a symbol definition from the symbol table. This command does not undefine the symbols defined in the loaded application.

Program variables whose names were redefined using the [UNDEF](#) command are visible again. Undefining an undefined symbol is not considered an error.

Usage

```
UNDEF symbol | *
```

If * is specified, all symbols defined previously using the command **DEFINE** are undefined.

Components

Debugger engine.

Debugger Engine Commands

Debugger Commands

Example:

```
DEFINE test = 1
...
UNDEF test
```

When the test variable is no longer needed in a command program, it can be undefined and removed from the list of symbols. After UNDEF test, the test variable can no longer be used without (re)defining it.

NOTE See also examples of the [DEFINE](#) command.

Examples:

The value of an existing symbol can be changed by applying the DEFINE command again. In this case, the previous value is replaced and lost. It is not put on a stack. Then when UNDEF is applied to the symbol, it no longer exists, even if the value of the symbol has been replaced several times:

```
in>DEFINE apple 0
in>LS
apple          0x0 (0)    // apple is equal to 0
in>DEFINE apple = apple + 1
in>LS
apple          0x1 (1)    // apple is equal to 1
in>DEFINE apple = apple + 1
in>LS
apple          0x2 (2)    // apple is equal to 2
in>UNDEF apple
in>LS
// apple no longer exists
```

In the next example, we assume that the FIBO.ABS sample is loaded. At the beginning, no user symbol is defined:

```
in>UNDEF *
in>LS
User Symbols:    // there is no user symbol
Application Symbols: // symbols of the loaded
```

```

application
fibonacciCount    0x800 (2048)
counter           0x802 (2050)
__startupData    0x84D (2125)
Fibonacci        0x867 (2151)
main             0x896 (2198)
Init            0x810 (2064)
__Startup       0x83D (2109)
in>DEFINE counter = 1
in>LS
User Symbols: // there is one user symbol: counter
counter       0x1 (1)
Application Symbols: // symbols of the loaded application
fibonacciCount    0x800 (2048)
counter           0x802 (2050)
__startupData    0x84D (2125)
Fibonacci        0x867 (2151)
main             0x896 (2198)
Init            0x810 (2064)
__Startup       0x83D (2109)
in>undef counter
in>LS
User Symbols: // there is no user symbol
Application Symbols: // symbols of the loaded application
fibonacciCount    0x800 (2048)
counter           0x802 (2050)
__startupData    0x84D (2125)
Fibonacci        0x867 (2151)
main             0x896 (2198)
Init            0x810 (2064)
__Startup       0x83D (2109)

```

Debugger Engine Commands

Debugger Commands

UNFOLD

In the Source component, the **UNFOLD** command is used to display the contents of folded source text blocks, for example, source text that has been collapsed at program block level. All text is unfolded once or (*) completely, until no more folded parts are found.

Usage

```
UNFOLD [*]
```

Where * means unfolding completely, otherwise unfolding only one level.

Components

Source component.

Example:

```
in>UNFOLD *
```

UNTIL

The **UNTIL** keyword is associated with the [REPEAT](#) command.

Usage

```
UNTIL condition
```

Where **condition** is defined as in “C” language definition.

Components

Debugger engine.

Example:

```
repeat
    open assembly
    wait 20
    define i = i + 1
until i==3
At the end of the loop, i = 3.
```

UPDATERATE

In the **Data component** and **Memory component**, the **UPDATERATE** command is used to set the data refresh update rate. This command only has an effect if the Data or Memory component to which it applies is set in Periodical Mode.

Usage

```
UPDATERATE rate
```

where **rate** is a constant number matching a quantity of time in tenths of a second, between 1 and 600 tenth of second (0.1 to 60 seconds).

Components

- Data and Memory component.

Example:

```
in>Memory < updatarate 30
```

This commands sets the Memory component updatarate to 3 seconds.

VER

The **VER** command displays the version number of the Debugger engine and components currently loaded in the Command line window.

Usage

```
VER
```

Components

Debugger engine.

Example:

```
in>ver  
HI-WAVE           6.0.27  
HI-WAVE Engine   6.0.49  
Source           6.0.20  
Assembly         6.0.14
```

Debugger Engine Commands

Debugger Commands

Procedure	6.0.10
Register	6.0.14
Memory	6.0.19
Data	6.0.27
Data	6.0.27
Simulator Target	6.0.17
Command Line	6.0.16

In the Command Line component window, Debugger engine and components versions are displayed.

WAIT

The **WAIT** command pauses command file execution for a time in tenths of second or pauses until the target is halted when the option “;s” is set.

When no parameter is specified, it pauses for 50 tenths of a second (5 seconds).

When only `time` is specified, execution of the command file is halted for the specified time.

When only `;s` is specified, execution of the command file is halted until the target is halted. If the target is already halted, command file execution is not halted.

When `time` and `;s` are specified:

If the target is running, command file execution is halted for the specified time only if the target is not halted. If the target is halted during the specified period of time (while command file execution is pending), the time delay is ignored and the command file is run.

If the target is already halted, command file execution is not halted (time delay is ignored).

NOTE The Wait instruction ends as soon as the PC is changed.

Usage

```
WAIT [time] [;s]
```

Components

Debugger engine.

Example:

```
WAIT 100  
T  
...
```

Pauses for 10 seconds before executing the T Trace instruction.

WB

The **WB** command sets a specified block of memory to a specified list of byte values. When the range is wider than the list of byte values, the list of byte values is repeated as many times as necessary to fill the memory block. When the range is not an integer, a multiple of the length of the list and the last copy of the list is truncated accordingly. This command is identical to the memory set ([MS](#)) command.

Usage

```
WB range list
```

range: is an address range constant that defines the block of memory to be set to the values of the bytes in the list.

list: is a list of byte values to be stored in the block of memory.

Alias

MS

Components

Debugger engine.

Example

```
in>WB 0x0205..0x0220 0xFF
```

This command fills up the memory range 0x0205..0x0220 with the 0xFF byte value.

Debugger Engine Commands

Debugger Commands

WHILE

The **WHILE** command allows you to execute a sequence of commands as long as a certain condition is true. The **WHILE** command may be nested.

This command can be stopped by pressing the **Esc** key.

Usage

```
WHILE condition
```

Where **condition** is defined as in “C” language definition.

Components

Debugger engine.

Example:

```
DEFINE jump = 0
...
WHILE jump < 20
    DEFINE jump = jump + 1
ENDWHILE
T
...
```

While `jump < 100`, the `jump` variable is incremented by the instruction `DEFINE jump = jump + 1`. Then the loop ends and the `T` Trace instruction is executed.

WL

The **WL** command sets a specified block of memory to a specified list of longword values. When the range is wider than the list of longword values, the list of longword values is repeated as many times as necessary to fill the memory block. When the range is not an integer or a multiple of the length of the list, the last copy of the list is truncated accordingly.

When a size is specified in the range, this size represents the number of longwords to modify.

Usage

`WL range list`

range: is an address range constant that defines the block of memory to be set to the longword values in the list.

list: is a list of longword values to be stored in the block of memory.

Components

Debugger engine.

Example:

```
in>WL 0x2000 0x0FFFFFF0F
```

This command fills up memory starting at address 0x2000 with the 0x0FFFFFF0F longword value, and modifies the addresses 0x2000 to 0x2003.

```
in>WL 0x2000, 2 0x0FFFFFF0F
```

This command fills up the memory area 0x2000 to 0x2007 with the longword value 0x0FFFFFF0F.

WW

The **WW** command sets a specified block of memory to a specified list of word values. When the range is wider than the list of word values, the list of word values is repeated as many times as necessary to fill the memory block. When the range is not an integer or a multiple of length of the list, the last copy of the list is truncated accordingly.

Usage

`WW range list`

range: is an address range constant that defines the block of memory to be set to the word values in the list.

list: is a list of word values to be stored in the block of memory.

Components

Debugger engine.

Example:

```
in>WW 0x2000..0x200F 0xAF00
```

This command fills up the memory range 0x2000..0x200F with the 0xAF00 word value.

Debugger Engine Commands

Debugger Commands

ZOOM

In the Data component, the **ZOOM** command is used to display the member fields of structures by ‘diving’ into the structure. In contrast to the [UNFOLD](#) command, where member fields are not expanded in place. The display of the member fields replaces the previous view. The **ZOOM out** command is used to return to the nesting level indicated by the given identifier.

NOTE Addresses are not needed to zoom out. Simply type “**ZOOM out**”.

NOTE This command is relevant when “C-source” debugging.

Usage

```
ZOOM address in|out
```

Where **address** is the address of the structure or pointer variable to zoom in or zoom out, respectively.

Components

Data component.

Example:

```
in>ZOOM 0x1FE0 in
```

The variable structure located at address **0x1FE0** is zoomed in.

```
in>zoom &_startupData
```

zooms in the **_startupData** structure (**&_startupData** is the address of the **_startupData** structure).

Book VIII - Environment Variables

Book VIII Contents

Each section of the Debugger manual includes information to help you become more familiar with the Debugger, to use all its functions and help you understand how to use the environment. This book, the Debugger Environment Variables, defines the HC08 and HC(S)08 environment variables, both those environment variables used by the debugger engine and those specific to individual debugger connections.

This book is divided into the following chapters:

- [Debugger Engine Environment Variables](#)
- [Connection-Specific Environment Variables](#)



Book VIII Contents

Debugger Engine Environment Variables

This chapter describes the environment variables that the Debugger uses. Other tools, such as the Linker, also use some of these environment variables. For more information about other tools, see their respective manuals.

Topics include:

- [Debugger Environment](#)
- [Local Configuration File \(usually project.ini\)](#)
- [ABSPATH: Absolute Path](#)
- [DEFAULTDIR: Default Current Directory](#)
- [ENVIRONMENT=: Environment File Specification](#)
- [GENPATH: #include "File" Path](#)
- [LIBRARYPATH: 'include <File>' Path](#)
- [OBJPATH: Object File Path](#)
- [TMP: Temporary directory](#)
- [USELIBPATH: Using LIBPATH Environment Variable](#)
- [Search Order for Source Files](#)
- [Debugger Files](#)

Debugger Environment

Various parameters of the Debugger may be set using environment variables. The syntax is always the same:

```
Parameter = KeyName "=" ParamDef.
```

NOTE Do not use blanks in the definition of an environment variable.

For example:

```
GENPATH=C:\INSTALL\LIB;D:\PROJECTS\TESTS;/usr/local/lib;/home/me/my_project
```

The Debugger parameters may be defined in several ways:

- Using system environment variables supported by your operating system.
- Putting the definitions in a file called `DEFAULT.ENV` in the default directory.

NOTE The maximum length of environment variable entries in the `DEFAULT.ENV/.hidefaults` is 4096 characters.

- Putting definitions in a file given by the value of the system environment variable `ENVIRONMENT`.

NOTE The default directory mentioned above can be set by using the system environment variable [DEFAULTDIR: Default Current Directory](#).

When looking for an environment variable, all programs first search the system environment, then the `DEFAULT.ENV` file and finally the global environment file given by `ENVIRONMENT`. If no definition can be found, a default value is assumed.

NOTE Ensure that no spaces exist at the end of environment variables.

The Current Directory

The most important environment for all tools is the current directory. The current directory is the base search directory where the tool begins to search for files (for example, the `DEFAULT.ENV/.hidefaults` file)

Normally, the current directory of a tool is determined by the operating system or program that launches another one (for example, WinEdit).

For MS Windows-based operating systems, the current directory definition is more complex.

-
- If the tool is launched using a File Manager/Explorer, the current directory is the location of the executable launched.
 - If the tool is launched using an Icon on the Desktop, the current directory is the one specified and associated with the Icon.
 - If the tool is launched by dragging a file on the icon of the executable under Windows 2000, the desktop is the current directory.
 - If the tool is launched by another tool with its own current directory specified (for example, WinEdit), the current directory is the one specified by the launching tool (for example, current directory definition in WinEdit).
 - For the Debugger tools, the current directory is the directory containing the local project file. Changing the current project file also changes the current directory, if the other project file is in a different directory. Note that browsing for a C file does not change the current directory.

To overwrite this behavior, the environment variable [DEFAULTDIR: Default Current Directory](#) may be used.

Global Initialization File (MCUTOOLS.INI - PC Only)

All tools may store global data in MCUTOOLS . INI. The tool first searches for this file in the directory of the tool itself (path of executable). If there is no MCUTOOLS.INI file in this directory, the tool looks for the file in the MS Windows installation directory (for example, C : \WINDOWS).

Example:

C : \WINDOWS\MCTYPEOLS . INI

D : \INSTALL\PROG\MCTYPEOLS . INI

If a tool is started in the D : \INSTALL\PROG\DIRECTORY, the project file in the same directory as the tool is used (D : \INSTALL\PROG\MCTYPEOLS . INI).

If the tool is started outside the D : \INSTALL\PROG directory, the project file in the Windows directory is used (C : \WINDOWS\MCTYPEOLS . INI).

NOTE For more information about MCUTOOLS . INI entries, see the compiler manual.

Local Configuration File (usually `project.ini`)

The Debugger does not change the `default.env` file. Its content is read only. All configuration properties are stored in the configuration file. The same configuration file can be used by different applications.

The shell uses the configuration file with the name `project.ini` in the current directory only. That is why this name is also suggested to be used with the Debugger. Only when the shell uses the same file as the compiler, the editor configuration written and maintained by the shell can be used by the Debugger. Apart from this, the Debugger can use any file name for the project file. The configuration file has the same format as windows `.ini` files. The Debugger stores its own entries with the same section name as in the global `mcutools.ini` file.

The current directory is always the directory containing the configuration file. If a configuration file in a different directory is loaded, then the current directory also changes. When the current directory changes, the `default.env` file is reloaded. Always when a configuration file is loaded or stored, options in the environment variable `COMOPTIONS` are reloaded and added to the project options. Beware of this behavior when a different `default.env` file exists in different directories, which contain incompatible options in `COMOPTIONS`.

When a project is loaded using the first `default.env`, its `COMOPTIONS` are added to the configuration file. If this configuration is stored in a different directory, where a `default.env` file exists with incompatible options, the Debugger adds options and marks the inconsistency. Then a message box appears to inform the user that the `default.env` options were not added. In such a situation the user can either remove the option from the configuration file with the option settings dialog box or remove the option from `default.env` with the shell or a text editor, depending on which options are needed in the future.

At startup there are three ways to load a configuration:

- use the command line option **prod**
- the `project.ini` file in the current directory
- or **Open Project** entry from the file menu.

If the option **prod** is used, then the current directory is the directory in which the project file is located. If **prod** is used with a directory, the `project.ini` file in this directory is loaded.

Default Layout Configuration (PROJECT.INI)

The default layout activated when starting the Debugger is defined in the PROJECT.INI file located in the project directory, as shown in [Listing 35.1](#). All default layout-related parameters are stored in section [DEFAULTS].

Listing 35.1 Example Content of PROJECT.INI:

```
[HI-WAVE]
Window0=Source      0   0  60  30
Window1=Assembly   60   0  40  30
Window2=Procedure  0  30  50  15
Window3=Terminal   0  45  50  15
Window4=Register   50  30  50  30
Window5=Memory     50  60  50  30
Window6=Data       0  60  50  15
Window7=Data       0  75  50  15
Target=Sim
```

Target: Specifies the target used when starting the Debugger (loads the file <target> with a .tgt extension), for example, Target=Sim for HC(S)08 Freescale Full Chip Simulator, or Target=Motosil, Target=Bdi.

Window<n>: Specifies coordinates of the windows that must be open when the Debugger is started. The syntax for a window is:

```
Window<n>=<component> <XPos> <YPos> <width> <height>
```

where **n** is the index of the window. This index increments for each window and determines the sequence in which windows open. In the case of overlapping windows, this index determines which windows appear on top of other windows. Values for the index must be in the range **0–99**.

Component specifies the component type to open, for example, **Source**, **Assembly**.

XPos specifies the X coordinate of the top left corner of the component (in percentage relative to the width of the main application client window).

YPos specifies the Y coordinate of the top left corner of the component (in percentage relative to the height of the main application client window).

width specifies the width of the component (in percentage relative to the width of the main application client window).

height specifies the height of the component (in percentage relative to the height of the main application client window).

Debugger Engine Environment Variables

Local Configuration File (usually `project.ini`)

Example:

```
Window5=Memory 50 60 50 30
```

Window number 5 is a Memory component, its starting position is at: 50% from main window width, 60% from main window height. Its width is 50% from main window width and its height 30% from main window height.

Other Parameters

- It is possible to load a previously saved layout from a file by inserting the following line in your `PROJECT.INI` file:

Layout=<LayoutName>

Where **LayoutName** is the name of the file describing the layout to be loaded, for example, **Layout=lay1.hwl**

NOTE The layout path can be specified if the layout is not in the project directory.

NOTE If **Layout** is defined in `PROJECT.INI`, the **Layout** parameter overwrites any **Window<n>** definition, describing the default windows layout.

- It is possible to load a previously saved project from a file by inserting the following line in your `PROJECT.INI` file:

Project=<ProjectName>

where **ProjectName** is the name of the file describing the project to be loaded, for example, **Project=Proj1.hwc**

NOTE The project path can be specified if the project is not in the project directory. This option can be used for compatibility with the old `.hwp` format (`Project=oldProject.hwp`) and opens as a new project file.

See [File Menu](#) section for more details about Projects.

NOTE If **Layout** and **Project** are defined in `PROJECT.INI`, the **Project** parameter overwrites the **Layout** parameter, also containing layout information.

```
MainFrame=<nbr.>, <nbr.>, <nbr.>, <nbr.>, <nbr.>, <nbr.>,
<nbr.>, <nbr.>, <nbr.>, <nbr.>
```

This variable is used to save and load the Debugger main window states: positions, size, maximized, minimized, display icons when opened, etc. This entry is used for internal purposes only.

- The toolbar, status bar, heading line, title bar and small border can be specified in the default section:
 - The toolbar can be shown or hidden with the following syntax:
`Toolbar = (0 | 1)`
 If 1 is specified, the toolbar is shown, otherwise the toolbar is hidden.
 - The status bar can be shown or hidden with the following syntax:
`Statusbar = (0 | 1)`
 If 1 is specified, the status bar is shown, otherwise the toolbar is hidden.
 - Title bars can be shown or hidden with the following syntax:
`Hidetitle = (0 | 1)`
 If 1 is specified, the title bars are hidden, otherwise they are shown.
 - The heading lines can be shown or hidden with the following syntax:
`Hideheadlines = (0 | 1)`
 If 1 is specified, the heading lines are hidden otherwise they are shown.
 - The border can be reduced with the following syntax:
`Smallborder = (0 | 1)`
 If 1 is specified, borders are thin otherwise they are normal.
- The environment variable BPTFILE authorizes the creation of breakpoint files; they may be enabled or disabled. All breakpoints of the currently loaded .abs file are saved in a breakpoints file. BPTFILE may be ON (default) or OFF. When ON, breakpoint files are created. When OFF, breakpoint files are not created.
`BPTFILE =(On | Off)`

NOTE Target specific environment variables can also be defined in the PROJECT . INI file. Refer to the specific target manual for details.

Ini File Activation

When a project file (PROJECT . INI) is activated, the following occurs (from first action to last):

- The old Project file is closed.
- Target Component is unloaded
- The environment variable (Path) is added from the Project file.

Debugger Engine Environment Variables

Local Configuration File (usually *project.ini*)

Select HI-WAVE section to retrieve value from:

- if an entry `Windows0` or `Target` can be retrieved from section `[HI-WAVE]` then:
use `[HI-WAVE]`
- else if an entry `Windows0` or `Target` can be retrieved from section `[DEFAULTS]` then:
use `[DEFAULTS]`
- else:
use `[HI-WAVE]`

The environment variables are loaded from the `default.env` file:

- If an entry `Layout=lll` exists, the layout file `lll.hwl` is loaded and executed.
- The target is set (if entry `Target=ttt` exists load target `ttt`).
- If an entry `Project=ppp` exists, the command file `ppp` is executed.
- The configuration file (`*.hwc`) is loaded (entry `configuration=* .hwc`).

Environment Variable Paths

Most environment variables contain path lists indicating where to search for files. A path list is a list of directory names separated by semicolons following the syntax below:

```
PathList = DirSpec {";" DirSpec}.
```

```
DirSpec = ["*"] DirectoryName.
```

Example:

```
GENPATH=C:\INSTALL\LIB;D:\PROJECTS\TESTS;/usr/local/hiwave/lib;/home/me/my_project
```

If a directory name is preceded by an asterisk ("`*`"), the programs recursively search the directory tree for a file, not just the given directory. Directories are searched in the order they appear in the path list.

Example:

```
GENPATH=. \; *S;O
```

NOTE Some DOS environment variables (like `GENPATH`, `LIBPATH`, etc.) are used.

We strongly recommend working with WinEdit and setting the environment by means of a `DEFAULT.ENV` file in your project directory. This project directory can be set in WinEdit's *Project Configure* menu command. This way, you can have different projects in different directories, each with its own environment.

NOTE When using WinEdit, do **not** set the system environment variable `DefaultDir`. If you do and this variable does not contain the project directory given in WinEdit's project configuration, files might not be put where you expect them.

Line Continuation

It is possible to specify an environment variable in an environment file (`default.env/.hidefaults`) over multiple lines by using the line continuation character `\`:

Example:

```
OPTIONS=\  
-W2 \  
-Wpd
```

This is the same as:

```
OPTIONS=-W2 -Wpd
```

Be careful when using the line continuation character with paths. For example:

```
GENPATH= . \  
TEXTFILE= . \txt
```

Results in:

```
GENPATH= . TEXTFILE= . \txt
```

To avoid such problems, use a semicolon ';' at the end of a path, if there is a `\` at the end:

```
GENPATH= . \ ;  
TEXTFILE= . \txt
```

Environment Variables

The remainder of this section is devoted to describing each of the environment variables available for the Debugger. The options are listed in alphabetical order and each is divided into several sections described in [Table 35.1](#).

Table 35.1 Environment Variable Details

Topic	Description
Tools	Lists of other tools that are using this variable
Synonym	Fore some environment variables a synonym also exists. The synonyms may be used for older releases of the Debugger and will be removed in the future. A synonym has lower precedence than the environment variable.
Syntax	Specifies the syntax of the option in EBNF format.
Arguments	Describes and lists optional and required arguments for the variable.
Default	Shows the default setting for the variable or none.
Description	Provides a detailed description of the option and how to use it.
Example	Gives an example of usage and effects of the variable where possible. The examples show an entry in the default.env file for PC.
See also	Names related sections.

ABSPATH: Absolute Path

Tools

SmartLinker, Debugger

Synonym

None

Syntax

```
ABSPATH=" {<path>}.
```

Arguments

<path>: Paths separated by semicolons, without spaces.

Description

When this environment variable is defined, the SmartLinker stores the absolute files it produces in the first directory specified. If ABSPATH is not set, the generated absolute files are stored in the directory in which the parameter file was found.

Example:

```
ABSPATH=\sources\bin;..\..\headers;\usr\local\bin
```

DEFAULTDIR: Default Current Directory**Tools**

Compiler, Assembler, Linker, Decoder, Librarian, Maker, Burner, Debugger.

Synonym

None.

Syntax

```
"DEFAULTDIR=" <directory>.
```

Arguments

<directory>: Directory specified as default current directory.

Default

None.

Description

With this environment variable the default directory for all tools may be specified. All tools indicated above take the specified directory as their current directory instead of the one defined by the operating system or launching tool (for example, editor).

NOTE This is an environment variable at the system level (global environment variable). It CANNOT be specified in a default environment file (DEFAULT.ENV/.hidefaults).

Debugger Engine Environment Variables

Environment Variables

Example:

```
DEFAULTDIR=C:\INSTALL\PROJECT
```

See also:

[The Current Directory](#)

[Global Initialization File \(MCUTOOLS.INI - PC Only\)](#)

ENVIRONMENT=: Environment File Specification

Tools

Compiler, Linker, Decoder, Librarian, Maker, Burner, Debugger.

Synonym

HIENVIRONMENT

Syntax

```
"ENVIRONMENT=" <file>.
```

Arguments

<file>: file name with path specification, without spaces

Default

None.

Description

This variable has to be specified at the system level. Normally the application looks in the [The Current Directory](#) for an environment file named `default.env`. Using `ENVIRONMENT` (for example, set in the `autoexec.bat` for DOS), a different file name may be specified.

NOTE This is an environment variable at the system level (global environment variable). It CANNOT be specified in a default environment file (`DEFAULT.ENV/.hidefaults`).

Example:

```
ENVIRONMENT=\Freescale\prog\global.env
```

GENPATH: #include “File” Path

Tools

Compiler, Linker, Decoder, Burner, Debugger.

Synonym

HIPATH

Syntax

```
"GENPATH=" {<path>}
```

Arguments

<path>: Paths separated by semicolons, without spaces.

Default

Current directory

Description

If a header file is included with double quotes, the Debugger searches in the current directory, then in the directories given by GENPATH and finally in the directories given by [LIBRARYPATH: ‘include <File>’ Path](#).

NOTE If a directory specification in this environment variable starts with an asterisk (“*”), the whole directory tree is searched recursively. All subdirectories and their subdirectories are searched. Within one level in the tree, search order is random.

Example:

```
GENPATH=\sources\include;..\..\headers;\usr\local\lib
```

See also:

Environment variable LIBPATH

LIBRARYPATH: 'include <File>' Path

Tools

Compiler, ELF tools (Burner, Linker, Decoder)

Synonym

LIBPATH

Syntax

```
"LIBRARYPATH=" {<path>}.
```

Arguments

<path>: Paths separated by semicolons, without spaces.

Default

Current directory

Description

If a header file is included with double quotes, the Compiler searches in the current directory, then in the directories given by [GENPATH: #include "File" Path](#) and finally in directories given by [LIBRARYPATH: 'include <File>' Path](#).

NOTE If a directory specification in the environment variables starts with an asterisk ("*"), the whole directory tree is searched recursively. All subdirectories and their subdirectories are searched. Within one level in the tree, search order is random.

Example:

```
LIBRARYPATH=\sources\include;..\..\headers;\usr\local\lib
```

See also:

Environment variable [GENPATH: #include "File" Path](#)

Environment variable [USELIBPATH: Using LIBPATH Environment Variable](#)

OBJPATH: Object File Path

Tools

Compiler, Linker, Decoder, Burner, Debugger.

Synonym

None.

Syntax

```
"OBJPATH=" <path>.
```

Default

Current directory

Arguments

<path>: Path without spaces.

Description

If a tool looks for an object file (for example, the Linker), then it first checks for an object file specified by this environment variable, then in [GENPATH: #include "File" Path](#) and finally in HIPATH.

Example:

```
OBJPATH=\sources\obj
```

TMP: Temporary directory

Tools

Compiler, Assembler, Linker, Librarian, Debugger.

Synonym

None.

Syntax

```
"TMP=" <directory>.
```

Debugger Engine Environment Variables

Environment Variables

Arguments

<directory>: Directory to be used for temporary files.

Default

None.

Description

If a temporary file has to be created, normally the ANSI function `tmpnam()` is used. This library function stores the temporary files created in the directory specified by this environment variable. If the variable is empty or does not exist, the current directory is used. Check this variable if you get an error message “Cannot create temporary file”.

NOTE This is an environment variable at the system level (global environment variable). It cannot be specified in a default environment file (`DEFAULT . ENV/ .hidefaults`).

Example:

```
TMP=C:\TEMP
```

See also:

[The Current Directory](#)

USELIBPATH: Using LIBPATH Environment Variable

Tools

Compiler, Linker, Debugger.

Synonym

None.

Syntax

```
"USELIBPATH=" ( "OFF" | "ON" | "NO" | "YES" )
```

Arguments

ON, YES: The environment variable [LIBRARYPATH: 'include <File>' Path](#) is used to look for system header files <*.h>.

NO, OFF: The environment variable [LIBRARYPATH: 'include <File>' Path](#) is not used.

Default

ON

Description

This environment variable allows a flexible usage of the [LIBRARYPATH: 'include <File>' Path](#) environment variable, because [LIBRARYPATH: 'include <File>' Path](#) may be used by other software (for example, version management PVCS).

Example:

```
USELIBPATH=ON
```

See also:

Environment variable [LIBRARYPATH: 'include <File>' Path](#)

Search Order for Source Files

This section describes the search order (from first to last) used by the debugger.

In the Debugger for C Source Files (*.c, *.cpp)

1. Path coded in the absolute file (.abs)
2. Project file directory (where the .pj1 or .ini file is located)
3. Paths defined in the GENPATH environment variable (from left to right)
4. Abs File directory

In the Debugger for Assembly Source Files (*.dbg)

1. Path coded in the absolute file (.abs)
2. Project file directory (where .pj1 or .ini file is located)
3. Paths defined in the GENPATH environment variable (from left to right)
4. Abs File directory

In the Debugger for Object Files (HILOADER)

1. Path coded in the absolute file (.abs)
2. Abs File directory
3. Project file directory (where .pjt or .ini file is located)
4. Path defined in the OBJPATH environment variable
5. Paths defined in the GENPATH environment variable (from left to right)

Debugger Files

The Debugger comes with several program, application, configuration files and examples. These files and file extensions are listed in the following table.

Table 35.2 Debugger File Extensions

File Extension	Description
*.ABS	Absolute framework application file e.g., fibo.abs
*.ASM	Assembler specific file e.g., macrodem.asm
*.BBL	Burner Batch Language file e.g, fibo.bbl
*.BPT	Debugger Breakpoint file e.g., fibo.bpt
*.C *.CPP	C and C++ source files
*.CHM	Compiled HTML help file
*.CMD	Command File Script, for example, Reset.cmd
*.CNF	Specific CPU configuration file
*.CNT	Help Contents File, for example, cxa.cnt
*.CPU	Central Processor Unit Awareness file
*.DBG	Debug listing files, for example, Fibo.dbg
DEFAULT.ENV	Debugger Default Environment file.

Table 35.2 Debugger File Extensions (continued)

File Extension	Description
*.DLL	A .DLL file that contains one or more functions compiled, linked, and stored separately from the processes that use them. The operating system maps the DLLs into the process's address space when the process is starting up or while it is running. The process then executes functions in the DLL. The DLL of the Debugger is provided for supported library and extended functions.
*.H	Header file
HIWAVE.EXE	The Debugger for Windows executable program.
*.HWL	Debugger Layout file, for example, default.hwl
*.HWC	Debugger Configuration file (project.hwc)
*.EXE	Other Windows executable program, for example, LINKER.EXE
*.FPP	Flash Programming Parameters files (CPU specific) for example, mcu0e36.fpp
*.HLP	Application Help file, for example, Hiwave.hlp
*.IO	I/O simulation file, for example, sample11.io
*.ISU	Uninstall Application File
*.PJT	Debugger configuration Settings File, for example, Project.pjt
*.INI	Debugger configuration Settings File, for example, Project.ini
*.LST	Assembler Listing File, for example, fibo.lst
*.MCP	Freescale CodeWarrior IDE project file
*.MAK	Make file, for example, demo.mak
*.MAP	Mapping file, for example, macrodem.map
*.MEM	Memory Configuration file, for example, 000p4v01.mem
*.MON	Firmware loading file for loading a specified target, for example, Firm0508.mon
*.O	Object file code, for example, Fibo.o
*.PDF	Portable Document Format file.
*.PRM	Linker parameter file, for example, fibo.prm

Debugger Engine Environment Variables

Debugger Files

Table 35.2 Debugger File Extensions (continued)

File Extension	Description
Project.Ini	Debugger Project Initialization File
*.REC	Recorder File
*.REG	Register Entries files, for example, mcu081e.reg
*.SIM	CPU Awareness file, for example, st7.sim
*.SX	S-Record file, for example, fibo.sx
*.TXT	General Text Information file.
*:TGT	Target File for the Debugger, for example, xtend-g3.tgt
*.WND	Debugger Window Component File, for example, recorder.wnd
*.XPR	Debugger User Expression file, for example, Fibo.xpr

Connection-Specific Environment Variables

Some of the environment variables that can be used in the debugging process are imported with the connection software and are specific to that connection.

Connection-Specific Environment Variables

There are currently no connection environment variables that can be manually edited.



Connection-Specific Environment Variables

Connection-Specific Environment Variables

Book IX - Debugger Legacy

Book IX Contents

Each section of the Debugger manual includes information to help you become more familiar with the Debugger, to use all its functions and help you understand how to use the environment.

This book is divided into the following chapters:

Book 9: Debugger Legacy

- [Legacy PEDebug Target Interface](#)
- [Legacy Target Interfaces Removed](#)
- [HC\(S\)08 Full-Chip Simulator Components No Longer Supported](#)



Book IX Contents

Legacy PEDebug Target Interface

The PEDebug Target Interface has become “Legacy” and has been replaced by specific Debugger Connections. The **Target Interface** term has been replaced by the term **Connection**.

New P&E Connections for HC(S)08

For the HC08 CPU, the following P&E connections have been created to replace the former Target Interfaces:

- Full Chip Simulation Connection
- Mon08 Interface Connection
- ICS Mon08 Interface Connection
- P&E Multilink/Cyclone Pro Connection
- ICS P&E Multilink/Cyclone Pro Connection

For the HCS08 CPU, the P&E following connections have been created:

- Full Chip Simulation Connection
- P&E Multilink/Cyclone Pro Connection

Refer to specific manual chapter to get further details about each connection.

“Revert to Full Chip Simulator” Feature Removed

These new connections NO LONGER revert to the default FCS when the hardware cannot be contacted. It is now necessary to open the Set Connection dialog box and to choose the FCS if that is the connection you want. The FCS is now a Connection with the same priority as any other connection.

Legacy PEDebug Target Interface

Connection Selection or Change Always Available within IDE

Connection Selection or Change Always Available within IDE

The CW08v5.x IDE featured a new menu option in the Project menu. The Change MCU/Connection option opens the Device and Connection dialog box, where you can change the currently selected project connection.

Automatic Upgrade Path for Projects Previously Created

The debugger automatically upgrades the previous connection to the current latest connection set in a previous project. Find further details in the Technical Note **TN 241**.

Legacy Target Interfaces Removed

The following hardware Target Interfaces have been discontinued:

For HC08 CPU:

- Hitex Emulator Target Interface
- MON08 Target Interface (originally HIWARE MON08 Target Interface)
- Trace32 Target Interface (Lauterbach Emulator)
- MMDS support
- MMEVS support

For HCS08 CPU:

- BDM_HCS08 Target Interface



Legacy Target Interfaces Removed

HC(S)08 Full-Chip Simulator Components No Longer Supported

List of HC(S)08 FCS Components No Longer Supported

The following components can be opened in the debugger layout within the Open Window Component dialog box, or with the OPEN command in the Command window. However, these components are only operational with the Legacy “Freescale HC(S)08 Instruction Set Simulator”, (formerly **Sim.tgt** target interface). Therefore, HC08 and HCS08 Full Chip Simulators do not support the following debugger components, which remain selectable and available for backward compatibility:

- Adc_dac
- Io_led
- Io_ports
- IT_keyboard
- Lcd
- Led
- MicroC
- Monitor
- Phone
- Push_buttons
- Segments_display
- Softtrace
- Stimulation
- Taillight
- Template



HC(S)08 Full-Chip Simulator Components No Longer Supported

List of HC(S)08 FCS Components No Longer Supported

- Testterm
- Timer
- Wagon
- Winlift

Index

A

- A command 742
- A icon 506
- About Box 52
- About menu entry 51
- About Option 399
- About option 500, 572, 682
- .abs file 61
- ABSPATH 850
- ACTIVATE command 742
- ADCLR command 259
- Add New Instrument menu entry 142, 143
- ADDI Command 259
- Address B edit box 522, 523
- Address edit box 530
- Address menu entry 65, 67, 94, 96
- ADDXPR command 743
- Align menu entry 144
- All menu entry 83
- All Text Folded At Loading menu entry 124
- Analog 146
- AND Mask 148
- Application
 - Assembly Step 205
 - Embedded 25
 - Loading 202, 708
 - Starting 202
 - Step In 203
 - Step Out 204
 - Step Over 204
 - Stopping 203
 - Target 25
- Arming trace 426
- Arrange Icons menu entry 51
- ASCII menu entry 96
- Assembly Components 64, 202, 203
- Assembly context menu entries 67
- Assembly Menu entries 65
- Assembly Step menu entry 42
- Assembly Step Out menu entry 43
- Assembly Step Over menu entry 43
- AT command 755

- Attributes 147
- ATTRIBUTES command 743
- Auto configure 581
- Auto menu entry 113
- Auto on Access 582
- Auto on Load 582
- Auto select according to MCUID 707
- Automatic menu entry 84, 96
- Automatic mode 82
- Automatically analyze FIFO content 532
- AUTOSIZE command 756

B

- B icon 506
- Background color 146
- Background color menu entry 48, 145
- Bar 146
- Barcolor 148
- Bardirection 148
- BASE command 756
- Base menu entry 107
- BC command 757
- BCKCOLOR command 758
- BD command 758
- Bin menu entry 84, 95, 113, 207
- Binary 209
- Binary format 207
- Bit Reverse menu entry 84, 95, 113
- Bitmap Instrument 148
- Bitnumber to Display 150, 151
- Blocks 702
- Bottom menu entry 144
- Bounces 152
- Bounces on Edge 152
- Bounding Box 146
- Breakpoint 64, 115, 505
 - Checking condition 161
 - Command 169
 - Conditional 167, 184
 - Counting 166, 184
 - Definition 157
 - Deleting 168

-
- Hardware 517
 - Marking 115
 - Multiple selection 161
 - Permanent 157
 - Position 164
 - Temporary 157, 165
 - with Register Condition 168
 - Breakpoint with Register Condition 167
 - BS command 759
 - Bus State Analyzer (BSA)
 - Arming 426
 - Cables 404
 - Defining events 421
 - Selecting record mode 424
 - Viewing data 426
 - Bus trace 481, 493, 501, 504, 674, 682
 - Bus Trace menu entry 578
 - Byte menu entry 94
- C**
- C Option 31
 - Cache size menu entry 625
 - Call Chain 104
 - CALL command 761
 - CANCLR Command 290
 - CANIN command 290
 - CANOUT command 291
 - Capture 526
 - Capture read/write values at Address B 526
 - Capture read/write values at Address B after access at Address A 526
 - Cascade menu entry 51
 - CD command 762
 - CF command 763
 - Clear 536
 - Clear menu entry 131
 - CLOCK command 765
 - Clock Frequency menu entry 578
 - Clock speed
 - Time tag 425
 - Clone Attributes menu entry 144
 - CLOSE command 766
 - Close I/Os menu entry 578
 - .cmd files 71
 - Cmd Option 31
 - CMDFILE command 767
 - Code coverage 519
 - Code profiling 519
 - CodeWarrior IDE and RS08 Open Source BDM
 - Connection 561
 - CodeWarrior IDE Integration 215
 - Collecting data 426
 - Color if Bit 150, 151
 - Command 154
 - Command File executing 71
 - Command File menu entry 45
 - Command File Window 45
 - Command Files menu entry 578, 580
 - Command Files window 580
 - Command Line 29
 - Command Syntax 731, 732
 - Commands
 - FOR 799
 - GOTO 790
 - GOTOIF 791
 - GRAPHICS 791
 - HELP 792
 - IF 792, 799
 - INSPECTOROUTPUT 793
 - INSPECTORUPDATE 794
 - LF 795
 - LOAD 796
 - LOADCODE 797
 - LOADSYMBOLS 798
 - LOG 798
 - LS 803
 - MEM 804
 - MS 805
 - NB 805
 - NOCR 807
 - NOLF 807
 - OPEN 808
 - OUTPUT 809
 - P 809
 - PAUSETEST 810
 - PRINTF 811
 - PTRARRAY 811
 - RD 812
-

-
- RECORD 813
 - REPEAT 799, 813
 - RESET 814
 - RESTART 814
 - RETURN 815
 - RS 815
 - S 816
 - SAVE 817
 - SAVEBP 817
 - SET 818
 - WHILE 799
 - Communication 673, 681
 - USB 408
 - COMPLEMENT
 - DATA Component 749
 - Memory Component 751
 - Register Component 746
 - Complex breakpoint 505
 - Component
 - Assembly 64, 202, 203
 - Associated Menus 52
 - Command Line 69
 - Connection 62
 - Coverage 73
 - CPU 61
 - DA-C 76
 - Data 79, 202, 203, 205
 - Framework 26
 - Inspector 133
 - IO_Led 595
 - LED 597
 - Main Menu 52
 - Memory 90, 212
 - Module 102
 - Phone 598
 - Pop Up Menu 53
 - Procedure 104
 - Profiler 106
 - Recorder 109
 - Register 111, 202, 209
 - SoftTrace 130
 - Source 115, 202, 203
 - Stimulation 624
 - Terminal 214
 - VisualizationTool 141
 - Window 61
 - Component Files 53
 - Component menu 47, 48
 - Components 403
 - COMPOPTIONS variable 844
 - Configuration menu entry 35
 - Configure menu entry 578
 - Connection (HC08FCS) List Menu 254
 - Connection Components 62
 - Connection menu 43, 44
 - Control Point
 - Definition 157
 - Dialogs 157
 - Control Points menu entry 43
 - Controlpoints Configuration window 508, 509, 513
 - Copy menu entry 120, 143
 - COPYMEM command 766
 - CopyMem menu entry 94
 - Copyright information, finding 51
 - Coverage 519, 538
 - Coverage components 73
 - Coverage menu entries 74
 - CPU
 - Components 61
 - Count 152
 - Cycles 33, 112
 - Cycles (64 bits) 578
 - CR command 767
 - Cross-debugging 25
 - Ctrl+A Shortcut 142
 - Ctrl+E Shortcut 142
 - Ctrl+L Shortcut 143
 - Ctrl+P Shortcut 142
 - Ctrl+S Shortcut 143
 - Ctrl+V Shortcut 142
 - CTRL-P Shortcut 145
 - Current Directory 842, 851
 - Customize menu entry 38
 - Customizing the toolbar 38
 - Cut menu entry 143
 - CYCLE command 768
 - CYCLES Command 264, 307
-

D

DA-C

- Configure file types 221
- Configuring 219
- Configuring tools 226
- Database directory 221
- Debugger Interface 230
- Debugger name 234
- IDE 219
- Library path 222
- Link Component 76
- Ndapi.dll 234
- New project 220
- Preprocessor
 - Header Directories 223
 - Preinclude file 223
- Project root directory 220
- Referential project root directory 221
- Requirements 219
- Source 222
- Synchronized debugging 233
- Troubleshooting 234
- True-Time Simulator and Real-Time
 - Debugger project file 232
- User help file 221
- Working directories, configuring 220

DASM command 768

Data

- Component 79, 202, 203, 205
- Value 537
- Viewing trace 426
- Window 509

Data menu entries 82

DB command 770

DBG 533

DBG FIFO Data 537

DBGCA 512, 513, 518

DBGCB 512, 513, 518

DBGFH 532, 537

DBGFL 532, 537

DBGT 519

DDE HI-WAVE server 217

DDEPROTOCOL command 771

Debugger

- DDE Capability (deprecated) 217
- MON08 Limitations 379
- Starting 28
- Tips 379

Debugger Commands

- A 742
- ACTIVATE 742
- ADDXPR 743
- AT 755
- ATTRIBUTES 743
- AUTOSIZE 756
- BASE 756
- BC 757
- BCKCOLOR 758
- BD 758
- BS 759
- CALL 761
- CD 762
- CF 763
- CLOCK 765
- CLOSE 766
- CMDFILE 767
- COPYMEM 766
- CR 767
- CYCLE 768
- DASM 768
- DB 770
- DDEPROTOCOL 771
- DEFINE 772
- DETAILS 774
- DL 775
- DUMP 776
- DW 776
- E 777
- ELSE 778
- ELSEIF 778
- ENDFOCUS 779
- ENDFOR 780
- ENDIF 780
- ENDWHILE 781
- EXECUTE 781
- EXIT 782
- FILL 782
- FILTER 783

FIND 783
 FINDPROC 784
 FOCUS 785
 FOLD 786
 FONT 786
 FOR 787
 FPRINTF 788
 FRAMES 788
 G 789
 GO 789
 GOTO 790
 GOTOIF 791
 GRAPHICS 791
 HELP 792
 IF 792
 INSPECTOROUTPUT 793
 INSPECTORUPDATE 794
 LF 795
 LOAD 796
 LOADCODE 797
 LOADSYMBOLS 798
 LOG 798
 LS 803
 MEM 804
 MS 805
 NB 805
 NOCR 807
 NOLF 807
 OPEN 808
 OUTPUT 809
 P 809
 PAUSETEST 810
 PRINTF 811
 PTRARRAY 811
 RD 812
 RECORD 813
 REPEAT 813
 RESET 814
 RESTART 814
 RETURN 815
 RS 815
 S 816
 SAVE 817
 SAVEBP 817
 SET 818
 SETCOLORS 819
 SLAY 819
 SLINE 820
 SMEM 821
 SMOD 821
 SPC 822
 SPROC 823
 SREC 824
 STEPINTO 824
 STEPOUT 825
 STEPOVER 826
 STOP 827
 T 827
 TESTBOX 828
 TUPDATE 829
 UNDEF 829
 UNFOLD 832
 UNTIL 832
 UPDATERATE 833
 VER 833
 WAIT 834
 WB 835
 WHILE 836
 WL 836
 WW 837
 ZOOM 838
 Debugger Start Option
 -C 31
 -Cmd 31
 -ENVpath 31
 -Instance=%currentTargetName 30
 -Nodefaults 31
 -Prod 30
 -T 30
 -Target 30
 -W 30
 Debugger Trigger Register 519
 Debugger window
 Object info bar 53
 Debugging 25
 Debugging Memory Map 673, 681
 Dec menu entry 84, 95, 113, 207
 Decimal format 207

Decimalmode 151
 Default IP address 412
 DEFAULT.ENV 842, 851, 852, 856
 default.mem file 580
 DEFAULTDIR 851
 DefaultDir 200
 DEFINE command 772
 Delete Breakpoint menu entry 67, 119
 Delete Markpoint menu entry 67, 120
 Delete Trigger 529
 Delete Trigger Address option 507
 Demo Version Limitations
 VisualizationTool 155
 Demo version limitations
 Full chip simulation 607
 DETAILS command 774
 Details menu entry 74, 107
 Disable Breakpoint menu entry 67, 119
 Disable Trace menu entry 131
 Disabled mode 520
 Disarm module automatically when debugger
 stops 532
 Display 0/1 149, 151
 Display Absolute Address menu entry 65
 Display Address dialog box 97
 Display Address menu entry 65
 Display Code menu entry 65
 Display Headline menu entry 145
 Display menu entry 94, 625
 Display Scrollbars menu entry 145
 Display submenu entries 96
 Display Symbolic menu entry 65
 Display Version 151
 Displayfont 153
 DL command 775
 Do not halt when fifo is full 528
 Drag Out 607
 Dragging 54
 Driving True-Time Simulator and Real-Time
 Debugger through DDE 217
 Drop Into 607
 Dump 536
 DUMP command 776
 Dump menu entry 131

DW command 776
 Dynamic trigger type 514

E

e Character trigger display 512
 E command 777
 EBNF command syntax 731
 Edit mode menu entry 142, 143, 145
 Editing
 Memory 212
 Register 210
 Variable 208
 Editing trigger addresses 529
 Editor 80
 EEPROM Modules 703
 ELSE command 778
 ELSEIF command 778
 Embedded application simulation 25
 Emulation module (EM)
 Defined 404
 Enable Breakpoint menu entry 67, 119
 Enable Trace menu entry 131
 ENDFOCUS command 779
 ENDFOR command 780
 ENDIF command 780
 ENDWHILE command 781
 Environment
 ABSPATH 850
 DEFAULTDIR 851
 ENVIRONMENT 842
 File 842
 GENPATH 853, 855
 HIENVIRONMENT 852
 HIPATH 853, 855
 LIBPATH 854, 856
 LIBRARYPATH 854
 OBJPATH 855
 TMP 855
 USELIBPATH 856
 Variable 850
 -ENVpath Option 31
 EQUAL Mask 148
 Erase Flash 492
 Events

-
- Defining 421
 - Record modes 424
 - EXECUTE command 781
 - Execute menu entry 625
 - EXIT command 782
 - Exit menu entry 35
 - Expert mode 512, 518
 - Expert triggers 518
 - Explorer 843
 - Expression Command File 81
 - Expression Editor 80
- F**
- FCS
 - ADC Module Option 258
 - ADC User Commands 259
 - Clock Generation Module Commands 261
 - Clock Generation Module Option 260
 - External Interrupt Module 268
 - High Resolution PWM (HRP) module 262
 - High Resolution PWM Commands 263
 - HRP Commands 263
 - Input/Output (I/O) Ports Module 265
 - Input/Output Ports Commands 266
 - IRQ Commands 268
 - Keyboard Interrupt Commands 270
 - Keyboard Interrupt Module 269
 - MSCAN Controller Module 276
 - Multi-Master Inter-Integrated Circuit (MMIIC) Module 272
 - Multi-Master Inter-Integrated Circuit Module Commands 274
 - Run Till Cycle Command 255
 - USB Commands 328
 - FCS Configuration Procedure 253
 - FCS Connection Menu
 - ADC Module Option 258
 - Clock Generation Module Option 260
 - Device Option 255
 - External Interrupt Module 268
 - High Resolution PWM Module 262
 - Input/Output (I/O) Ports Module 265
 - Keyboard Interrupt Module 269
 - Modules (Peripherals) Options 257
 - Multi-Master Inter-Integrated Circuit Module Option 272
 - Programmable Timer Interrupt Module 291
 - Select Device Option 255
 - Serial Communications Interface Module 292
 - Serial Peripheral Interface Module Option 300
 - Slave LIN Interface Controller Module 296
 - Timer Interface Module Option 304
 - Universal Serial Bus (USB) Module 309
 - View Register Files Option 256
 - FCS Peripherals (Modules) Options 257
 - FCSDemo CAN Program 277
 - FCSMSCAN Commands 290
 - FCSSCI Commands 294
 - FCSSLIC Commands 298
 - FCSSPI Commands 302
 - FCSTimer Interface Module Commands 307
 - Field Description 153, 154
 - FIFO 532, 533, 536
 - FIFO Analyze remark 533
 - FIFO Depth 537
 - File
 - Environment 842
 - Manager 843
 - File Menu 35
 - Filename 148
 - Files
 - default.mem 580
 - init.cmd 201
 - mcutools.ini 199
 - postload.cmd 47
 - preload.cmd 47
 - project.ini 706, 707
 - reset.cmd 47
 - Setcpu command 580
 - FILL command 782
 - Fill Memory dialog box 97
 - Fill menu entry 94
 - FILTER command 783
 - FIND command 783
 - Find dialog box 122
 - Find menu entry 120
-

-
- Find Procedure dialog box 123
 - Find Procedure menu entry 121
 - FINDPROC command 784
 - Flash 674, 682
 - Commands 710
 - Disabling 705
 - Enabling 705
 - Loading 708
 - Module 703
 - Operations 705
 - Option 481
 - Protecting 705
 - Select 703
 - Unprotecting 705
 - Unselect 703
 - FLASH command 710
 - Flash module
 - Selecting 705
 - FLASH SELECT 703, 706
 - FLASH UNSELECT 703, 706
 - Flexis connections 22
 - Flexis devices 22
 - FLEXIm 26
 - Float menu entry 113
 - FOCUS command 785
 - Fold All Text menu entry 124
 - FOLD command 786
 - Fold menu entry 124
 - Folding 118
 - Mark 118
 - Folding Menu 123
 - Folding menu entries 124
 - Foldings menu entry 121
 - FONT command 786
 - Fonts menu entry 48
 - FOR command 787, 799
 - Format menu entries 207
 - Format menu entry 82, 94
 - Format mode 153
 - Format Selected Mode menu entries 84
 - Format submenu entries 83, 95
 - Format, changing 207, 209
 - FPP directory 706
 - .FPP file loading 706
 - FPRINTF command 788
 - Frame 533
 - Frames 130
 - FRAMES command 788
 - Frozen menu entry 85, 96
 - Frozen mode 82
 - FSICEBASE
 - Assigning an IP address 412
 - Bus Analyzer Configuration dialog box 422
 - Bus State Analyzer (BSA) 421
 - Communication dialog box 408
 - Communication through Ethernet Port 407
 - Communication through USB Port 408
 - Components 403
 - Emulation system reset 419
 - Establishing communication 407
 - IP address 412
 - Logic cables and connectors 419
 - Memory Map dialog box 416
 - Overview 401
 - Setting up hardware 405
 - Specifying clock speed 417
 - Specifying communication information 410
 - Specifying Memory Map 414
 - System components 403
 - System requirements 402
 - System set up 405, 409
 - Target Signals dialog box 418
 - FSICEBASE Emulator 401
 - Full Chip Simulation
 - ColdFire 577
 - HC08 253
 - HCS08 431
 - RS08 547
 - Full Chip Simulation (FCS) Connection 253
 - Full Chip Simulation Module Commands 255
- ## G
- G command 789
 - GDI 532
 - GDI connection 524
 - GENPATH 853, 855
 - Global menu entry 82
 - Global variable
-

-
- Display 206
 - display 82
 - Values and types 79
 - GO command 789
 - Go to Frame 536
 - Go to Frame menu entry 131
 - Go to Line dialog box 122
 - Go to Line menu entry 120, 122
 - GOTO command 790
 - GOTOCYCLE Command 264, 307
 - GOTOIF command 791
 - Graphic bar 73, 106
 - Graphical 534
 - Graphical display 534
 - Graphical menu entry 131
 - GRAPHICS command 791
 - Graphics menu entry 74, 107
 - Grid Color menu entry 145
 - Grid Mode menu entry 145
 - Grid Size menu entry 145
- H**
- Halt menu entry 42
 - Halt when fifo is full 528
 - Hardware
 - Components 403
 - Setup 405
 - Hardware breakpoints 517
 - Hardware design simulation 25
 - HC08 Full Chip Simulation 253
 - HC08FCS Menu
 - ADC Module Extended Menu Options 257
 - HCS08 derivatives with DBG module 503
 - HCS08 FCS
 - ADC module 436
 - ADC module commands 437
 - Clock Generation module 438
 - Clock Generation module commands 439
 - Configuration Procedure 431
 - Connection Menu 432
 - Connection Menu module commands 433
 - Device Option Extended Menu 433
 - External Interrupt (IRQ) module 447
 - Input/Output (I/O) Ports module 444
 - Input/Output Ports user commands 445
 - Inter-Integrated Circuit module 440
 - Inter-Integrated Circuit module
 - commands 442
 - IRQ commands 449
 - Keyboard Interrupt commands 451
 - Keyboard Interrupt module 450
 - Modulo Timer Interrupt module 452
 - Peripheral Modules commands 435
 - SCI commands 455
 - Serial Communications Interface
 - module 453
 - Serial Peripheral Interface module 457
 - Set Connection Dialog Box 431
 - SPI commands 458
 - Timer Interface module 461
 - Timer Module commands 463
 - HCS08 Full Chip Simulation 431
 - HCS08 Multilink/Cyclone Pro
 - Additional Connection menu options 471
 - Advanced Programming/Debug option 471
 - Bus Trace option 475
 - Connection Assistant dialog box 468
 - Connection procedure 467
 - Device option 470
 - Device Option extended menu 470
 - Expert Programmer window 473
 - Set Connection dialog box 467
 - Start Expert Mode Programmer option 473
 - Trigger Module Settings option 474
 - View Register Files option 473
 - HCS08 MultilinkCyclonePro
 - Connection menu 470
 - HCS08 Open Source BDM 477
 - Bus Trace 481
 - Connection Menu options 480
 - First Steps from within existing project 479
 - First Steps Using the Stationery Wizard 478
 - Flash 481
 - HCS08 Open Source BDM Setup dialog
 - box 482
 - Information required to unsecure the
 - device 484
 - MCU Configuration dialog box 480
-

-
- Reset to Normal Mode 481
 - Select derivative 481
 - Select Derivative dialog box 483
 - Set Connection dialog box 479
 - Setup 480
 - Show Status 481
 - Show Status dialog box 485
 - Technical considerations 477
 - Trigger Module settings 481
 - Unsecure 481
 - Wizard Connection selection 478
 - HCS08 P&E Multilink/Cyclone Pro
 - Connection 467
 - HCS08 Serial Monitor 503, 524
 - CodeWarrior IDE and serial monitor connection 487
 - Connection menu options 492
 - Derivative Selection dialog box 490, 495
 - First Steps from within existing project 489
 - First Steps using Stationery Wizard 488
 - Microcontrollers New Project Wizard window 488
 - Monitor Communication Tab 493
 - Monitor Setup Window
 - Monitor Communication Tab 493
 - Vector Table Mirroring Tab 491
 - Monitor Setup window 490
 - Set Connection dialog box 489
 - Technical considerations 487
 - Vector Table Mirroring Tab 494
 - HCS08 Serial Monitor connection 487
 - Height 146
 - HELP command 792
 - Help menu 51
 - Help Topics menu entry 51
 - Hex 210
 - Hex menu entry 84, 95, 113, 207
 - Hexadecimal 207, 209
 - Hexadecimal format 207
 - Hide Headline menu entry 38
 - Hide Tile menu entry 38
 - .hidefaults 842, 851, 852, 856
 - HIENVIRONMENT 852
 - High Display Value 147, 148, 150, 154
 - HIPATH 853, 855
 - Horiz. Text Alignment 153
 - Horizontal Size menu entry 144
 - How To information 199
 - .HWC file 35
 - .hwl 846
 - .hwp 846
- ## I
- ICS MON08
 - Added Connection Menu Options 358
 - Advanced Options Dialog Box 358
 - Advanced Programming/Debug Options 358
 - Cable Connection Communications Type 353
 - Connection Manager Window
 - Advanced Settings Tab 352
 - Connect to Target Tab 350
 - Connection Manager Window STATUS Area 355
 - Connection Menu Advanced Programming/Debug Options 358
 - Connection Menu Start Expert Mode Programmer Option 359
 - Connection Menu View Register Files Option 360
 - Connection Procedure 350
 - Cycle Power Button 354
 - Expert Mode Programmer Window 360
 - Interface Connection 349
 - Interface Selection Dialog Box 351
 - Power Up and Power Down Buttons 353
 - Set Connection Dialog Box 350
 - Start Expert Mode Programmer Option 359
 - Target MCU Security Bytes 355
 - Tpd and Tpu Timing Textboxes 352
 - View Register Files Option 360
 - ICS Multilink/Cyclone Pro
 - Additional Connection Menu Options 390
 - Advanced Options Dialog Box 390
 - Advanced Programming/Debug Option 390
 - Advanced Settings Tab 384
-

-
- Connection Manager Window - Advanced Settings Tab 384
 - Connection Manager Window Connect to Target Tab 382
 - Connection Manager Window STATUS Area 387
 - Connection Menu Added Menu Options 390
 - Connection Procedure 382
 - Cycle Power Up/Down Button 387
 - Device Class Description 393
 - Expert Mode Programmer Window 392
 - MON08 Cable Connection Communications Type 385
 - Power Up/Down Buttons 386
 - Remove a Manually Configured Interface 383
 - Set Connection Dialog Box 382
 - Start Expert Mode Programmer Option 391
 - Target MCU Security Bytes 387
 - Tpd and Tpu Timing Textboxes 385
 - View Register Files Option 392
 - ICS P&E Multilink/Cyclone Pro Connections 381
 - ICS08RKW Register Block Window 256, 345, 360, 378, 392, 434, 473
 - IDF 217
 - IF command 792, 799
 - IICCLR command 276
 - IICDI Command 274
 - IICDO Command 276
 - inDART-HC08 About option 399
MCU Configuration option 398
User's Manual 398
 - inDART-HCS08 503
 - Indicator color 147, 150
 - Indicatorlength 147
 - .INI 35
 - init.cmd 201
 - INPUT command 267, 271
 - INPUTS Command 267, 269, 308
 - INPUTS command 271
 - Inspector Component 133
 - INSPECTOROUTPUTcommand 793
 - INSPECTORUPDATE command 794
-Instance=%currentTargetName Option 30
 - Instruction at Address A and value on data bus match 525
 - Instruction at Address A and value on data bus mismatch 525
 - Instruction at Address A is executed 523
 - Instruction at Address A or Address B is executed 524
 - Instruction execution inside Address A - Address B range 524
 - Instruction execution outside Address A - Address B range 524
 - Instruction frames 130
 - INSTRUCTION markpoint type 513
 - Instruction trigger type 514
 - Instructions at Address A then at Address B were executed 524
 - Instructions display 533
 - Instructions menu entry 131
 - Instrument 7-Segment Display 150
DILSwitch 149
Knob 149
LED 150
Switch 151
Text 152
 - Instrument Attributes 146
 - Interruption 605
 - IP address Default 412
 - Items 535
 - Items menu entry 131
- K**
- Kind of Port 146
 - Kind of Switch 152
 - Knob Color 150
- L**
- Layout 846
 - Layout - Load/Store menu entry 51
 - Layout management 27
-

-
- LED instrument attributes 150
 - Left menu entry 144
 - LF command 795
 - LIBPATH 856
 - LIBRARYPATH 854
 - Line Continuation 849
 - Load a connection 44
 - Load Application menu entry 35
 - LOAD command 796
 - Load I/Os menu entry 578
 - Load Layout menu entry 143
 - Load menu entry 44, 578
 - LOADCODE command 797
 - Loading an Application 202
 - Loading error 708
 - Loading problems 708
 - LOADSYMBOLS command 798
 - Local menu entry 82
 - Local variable
 - Display 82
 - Displaying 205
 - Values and types 79
 - Locked menu entry 85
 - Locked mode 82
 - LOG command 798
 - Low Display Value 147, 148, 150, 154
 - LS command 803
 - Lword menu entry 94
- M**
- Main Window toolbar 33
 - MainFrame 846
 - Manual Configuration 583
 - Mark color 147
 - Marking breakpoints 115
 - Markpoint types 513
 - Markpoints 508
 - Definition 157
 - Deleting 67
 - Showing 67
 - Markpoints tab 509, 513
 - Markpoints, setting 67
 - Marks 147
 - Marks menu entry 121
 - Match value 522, 525
 - MCU Communication 398
 - MCU Configuration option 572
 - MCU configuration option 500
 - MCUID 706
 - MCUTOOLS.INI 843
 - MCUTOOLS.INI file 199
 - MEM command 804
 - Memory
 - Dump 90
 - Word 90
 - Memory access
 - at Address A 521
 - at Address A and value on data bus match 522
 - at Address A and value on data bus mismatch 523
 - at Address A or B 521
 - at Address A then at Address B 521
 - inside Address A - Address B range 521
 - Memory Component 90, 212
 - Memory Configuration Modes 582
 - Memory map
 - Modifying 416
 - Viewing 415
 - Memory menu entries 94
 - Memory window 509
 - Memory Write Access trigger type 530
 - Menu
 - Component 47
 - Connection 43
 - Help 51
 - Run 41
 - View 38
 - Window 50
 - Misaligned access 581
 - Mismatch value 523, 525
 - Mode menu entry 82, 94
 - Mode submenu entries 84, 96
 - Modify Trigger 529
 - Module Component 102
 - Modules
 - Source 103
 - MON08
-

-
- 16-Pin Header Signals tab
 - Status Area 340
 - Advanced Options Dialog Box 343
 - Cable Connection Communications
 - Type 336
 - Connection Manager Window
 - 16-Bit Header Signals Tab 339
 - Advanced Settings tab 335
 - Connect Target Tab 333
 - Connection Menu Options, Additional 342
 - Connection View Register Files
 - Menu Option 345
 - Device Class Description 346
 - Expert Mode Programmer Window 344
 - Interface Connection 333
 - Interface debugger connection 333
 - Interface Selection Dialog Box 334
 - Limitations 379
 - Power Cycle Control 338
 - Power Up/Power Down Controls 337
 - Removing Interface connection 335
 - Tips 379
 - Tpd and Tpu Timing 335
 - Monitor communication 492
 - MONITOR-HCS08
 - Bus Trace 493
 - Erase Flash 492
 - Monitor communications 492
 - Select Derivative 493
 - Trigger Module Settings 492
 - Vector Mirroring Setup 492
 - MS command 805
 - Multilink/Cyclone Pro
 - Advanced Options Dialog Box 376
 - Advanced Settings Tab 368
 - Connection Manager Dialog Box 367
 - Connection Manager Window
 - Advanced Settings Tab 368
 - Connect to Target Tab 366
 - Connection Manager Window Interface
 - Details Area 371
 - Connection Manager Window STATUS Area 372
 - Connection Menu Added Options 375
 - Connection Menu Advanced Programming/ Debug Option 376
 - Connection Menu View Register Files Option 378
 - Connection Procedure 365
 - Cycle Power Button 370
 - Debugging Limitations 379
 - Device Class Description 380
 - Device Power Selection List 366
 - Expert mode Programmer Window 377
 - HC08 Device Extended Menus 375
 - Interface Selection Dialog Box 367
 - MON08 Cable Connection Communications
 - Type 369
 - Power Up and Power Down Buttons 369
 - Remove a Manually Configured Interface 367
 - Set Connections Dialog Box 365
 - Start Expert Mode Programmer Option 377
 - Target MCU Security Bytes 371
 - Tpd and Tpu Timing Textboxes 368
 - Multilink/Cyclone Pro Connection Menu 374
 - MultilinkCyclonePro Connection Menu
 - Device Option 374
- N**
- Nb Bounces 152
 - NB command 805
 - New menu entry 35
 - Next menu entry 132
 - NOCR command 807
 - Nodefaults Option 31
 - NOLF command 807
 - NV_PARAMETER_FILE 706
 - NVMC Commands 710
 - NVMC Dialog
 - End 704
 - Name 704
 - Start 704
 - State 704
 - NVMC dialog box 703
 - NVMC Graphical User Interface 702
-

O

Object Info Bar 53
 OBJPATH 855
 Oct menu entry 84, 95, 113, 207
 Octal 207
 Octal format 207
 OPEN command 808
 Open Component menu entry 48
 Open Configuration menu entry 35
 Open File menu entry 625
 Open Memory Block 583
 Open Source File menu entry 120
 Options
 Autosize menu entry 51
 Component Menu menu entry 51
 Pointer As Array 82
 Setup 480
 Options group 200
 Options menu entry 82
 OSEK Kernel Awareness 190
 OSEK ORTI 191
 OSEK RTK Inspector 193
 OSPARAM.PRM 186
 Outlinecolor 151
 OUTPUT command 809
 Output File menu entry 74, 107

P

P command 809
 P&E Debug 503
 P&E Multilink Cyclone Pro for ColdFire
 Bus Trace 674
 CodeWarrior IDE and P&E Multilink
 Cyclone Pro connection 669
 Communication 673
 Connection menu options 673
 Debugging Memory Map 673
 First Steps from within existing project 671
 First Steps using Stationery Wizard 670
 Flash 674
 MCU Configuration 673
 MCU Configuration dialog box 676
 Set Connection dialog box 671

Set Derivative dialog box 672
 Setup 673
 Target Connection dialog box 672, 675
 Technical considerations 669
 Trigger Module Settings 674
 Wizard connection selection 670
 Paste menu entry 142, 144
 PATH 848
 Pause button 110
 PAUSETEST command 810
 PEDebug 503
 Percentage of executed code 73
 Percentage values 106
 PERIODICAL 625
 Periodical menu entry 84, 96
 Periodical mode 82
 Phone component 598
 .PJT file 35
 Play 109
 Pointer as Array 82
 Pointer as Array option 86
 Port to Display 146
 Postload command file 47
 postload.cmd file 47
 Preload command file 47
 preload.cmd file 47
 Previous menu entry 132
 PRINTF command 811
 Procedure 104
 Procedure Chain 104
 Procedure Component 104
 -Prod Option 30
 Profiler Component 106
 Profiler menu entries 107
 Profiling 519, 538
 Program flow rebuild gap 533
 Program loading
 in Flash 708
 Project 846
 PROJECT.INI 43, 845
 project.ini 845
 project.ini file 706, 707, 844
 Properties menu entry 142, 143

Protect DBG FIFO content from unexpected reads 532
 PTRARRAY command 811
 Pulse Width 152
 PVCS 857

R

R command 256, 345, 360, 378, 392, 434, 473, 558
 R/W Access 529
 RAM 379
 RD command 812
 Read 529
 Read access 510
 Read Access trigger type 514
 Read/Write access 510
 Read/Write Access trigger type 514
 READACCESS markpoint type 513
 READWRITEACCESS markpoint type 513
 Real Time Kernel Awareness 185
 Real Time Kernels 185
 Real-time
 Embedded application 25
 .rec files 110
 Record 109
 RECORD command 813
 Record continuously
 and DO NOT halt on trigger hit 527
 and halt on trigger hit 527
 Record menu entry 110
 Record Time menu entry 110
 Recorder Component 109
 Recorder menu entries 110
 Recording modes 424
 Refresh Mode menu entry 145
 Register Component 111, 202, 209
 Register content 111
 Register menu entries 113
 Register values 167, 168, 177
 Registration information 52
 Relative Mode 154
 Remove menu entry 143
 Remove MON08 Interface connection 335
 REPEAT command 799, 813

Replay menu entry 110
 Requirements 402
 RESET command 814
 Reset command file 47
 Reset Connection 44
 Reset Mem menu entry 578
 Reset menu entry 44, 74, 107, 578
 Reset RAM menu entry 578
 Reset Statistic menu entry 578
 Reset to Normal Mode option 481
 reset.cmd file 47
 RESTART command 814
 Restart menu entry 42
 RETURN command 815
 Right menu entry 144
 ROM 379
 RS command 815
 RS08 FCS
 Configuration procedure 547
 Connection menu 548
 Full Chip Simulation module commands 549
 Menu Device extended menus 548
 Peripheral modules commands 552
 Set Connection dialog box 547
 RS08 Full Chip Simulation 547, 577
 RS08 Multilink/Cyclone Pro
 Additional Connection menu options 556
 Advanced Programming/Debug option 556
 Connection Assistant dialog box 554
 Connection procedure 553
 Device option 555
 Device option extended menu 555
 PROGRS08 Programmer window 557
 Set Connection dialog box 553
 Start Expert Mode Programmer option 557
 View Register Files option 558
 RS08 MultilinkCyclonePro
 Connection menu 555
 RS08 Open Source
 Setup 564
 RS08 Open Source BDM 561
 Connection menu options 564
 First Steps from within existing project 563

-
- First Steps Using Stationery Wizard 562
 - MCU Configuration dialog box 564
 - Reset to normal mode 565
 - Select derivative 564
 - Select derivative dialog box 566
 - Set Connection dialog box 563
 - Setup dialog box 565
 - Show Status 565
 - Show Status dialog box 566
 - Technical considerations 561
 - Wizard Connection Selection 562
 - RS08 P&E Multilink/Cyclone Pro
 - Connection 553
 - Run menu 41, 42, 43
 - Run To Cursor menu entry 67, 120
- S**
- S command 816
 - Save and Restore on load option 509, 513
 - SAVE command 817
 - Save Configuration menu entry 35
 - Save Layout menu entry 143
 - Save Memory Block 583
 - Save Project As menu entry 35
 - SAVEBP command 817
 - SCCLR Command 294
 - SCDI Command 294
 - SCDO Command 295
 - Scope menu entry 82
 - Scope submenu entries 82
 - Search 131
 - Search order 857
 - Assembly source files 857
 - C source files 857
 - Object files source files 858
 - Search Trace menu entry 131
 - Search Trace Setup menu entry 132
 - Select
 - Derivative 481
 - Memory map 416
 - Select All menu entry 142
 - Select Core menu entry 578
 - Select Derivative 673, 681
 - Select derivative 493
 - Selected menu entry 83
 - Send to Back menu entry 144
 - Send to Front menu entry 144
 - Serial Monitor 524
 - Set Breakpoint menu entry 67, 119
 - SET command 818
 - Set Connection Dialog Box
 - Full Chip Simulation Option 253
 - Set Connection menu entry 48
 - Set DBGCA 512
 - Set DBGCB 512
 - Set Derivative menu entry 578
 - Set Markpoint menu entry 120
 - Set Program Counter menu entry 120
 - Set Trigger A 517
 - Set Trigger Address 506, 510
 - Set Trigger Address A 512
 - Set Trigger Address B 512
 - Set Trigger B 517
 - SETCOLORS command 819
 - Setcpu command file 580
 - Setup 405, 673, 681
 - Setup menu entry 143
 - Setup Option 480
 - Show Breakpoints menu entry 67, 120
 - Show Location 530, 534
 - Show Location menu entry 67, 120
 - Show Markpoint menu entry 67
 - Show Markpoints 508
 - Show Markpoints menu entry 67, 120
 - Show Status option 481
 - SHTDWN Command 265
 - Simulation 25
 - Simulator Menu 578
 - Single Step menu entry 42
 - Size menu entry 144
 - Size of Port 146
 - SLAY command 819
 - SLCCLR Command 298
 - SLCDI Command 299
 - SLCOUT Command 300
 - SLINE command 820
 - Sloping 151
 - Small Borders menu entry 38
-

-
- SMEM command 821
 - SMOD command 821
 - SofTec ColdFire
 - About 682
 - Bus Trace 682
 - CodeWarrior IDE and SofTec ColdFire connection 677
 - Communication 681
 - Communication Settings dialog box 684
 - Connection menu options 681
 - Debugging Memory Map 681
 - First Steps from within existing project 679
 - First Steps using Stationery Wizard 678
 - Flash 682
 - Select Derivative 681
 - Set Connection dialog box 679
 - Set Derivative dialog box 680, 685
 - Setup 681
 - SofTec ColdFire Setup dialog box 682
 - Target Connection dialog box 680, 683
 - Technical considerations 677
 - Trigger Module Settings 681
 - Wizard connection selection 678
 - SofTec HC08
 - CodeWarrior and SofTec HC08 Connection 395
 - Communication Settings Dialog Box 399
 - First Steps Using the Stationery Wizard 241
 - From Within an Existing Project 397
 - inDart-HC08 Connection Menu Options 398
 - MCU Configuration Dialog Box 398
 - Set Connection Dialog Box 397
 - Technical Considerations 240, 395
 - Using the Stationery Wizard 396
 - Wizard Connection Selection 396
 - Softec HC08
 - Connection 395
 - SofTec HCS08
 - About 500
 - Bus Trace 501
 - CodeWarrior IDE and SofTec HCS08 connection 497
 - Communication Settings dialog box 501
 - Connection menu options 500
 - First Steps from within existing project 499
 - First Steps using Stationery Wizard 498
 - MCU Configuration 500
 - MCU Configuration dialog box 500, 501
 - Set Connection dialog box 499
 - Technical considerations 497
 - Trigger Module Settings 501
 - Wizard connection selection 498
 - Softec HCS08
 - Connection 497
 - SofTec RS08
 - About 572
 - CodeWarrior IDE and SofTec RS08 Connection 567
 - Communication Settings dialog box 572
 - Connection menu options 571
 - First Steps from within existing project 570
 - First Steps Using Stationery Wizard 568
 - MCU Configuration 572
 - MCU Configuration dialog box 571, 572
 - Set Connection dialog box 570
 - Technical considerations 567
 - Wizard connection selection 568
 - Softec RS08
 - Connection 567
 - SoftTrace Component 130
 - Source associated context menu entries 119
 - Source code
 - Folding 118
 - Unfolding 118
 - Source Component 115, 202, 203
 - Source modules 103
 - SPC command 822
 - SPCLR Command 302
 - SPDI Command 302
 - SPDO Command 303
 - SPFREQ Command 304
 - Splitting View 73
 - SPROC command 823
 - SREC command 824
 - Start recording 110
 - Start recording after trigger hit and DO NOT halt when fifo is full 528
-

-
- Start recording after trigger hit and halt when fifo is full 527
 - Start/Continue menu entry 42
 - Starting an Application 202
 - Startup 844
 - Startup command file 46
 - Static text attributes 153
 - Statistics
 - Resetting 107
 - Status bar 33
 - DBG support 515
 - Menu entry 38
 - Status register bits 111
 - Step In 203
 - Assembly Instruction 205
 - Source Instruction 204
 - Step Out 203
 - Function Call 204
 - Step Out menu entry 42
 - Step Over 203, 204
 - Step Over menu entry 42
 - STEPINTO command 824
 - STEPOUT command 825
 - STEPOVER command 826
 - Stimulation Menu 625
 - STOP command 827
 - Stopping an Application 203
 - Switch Color 149, 152
 - Symbolic menu entry 84, 207
 - System
 - Components 403
 - Requirements 402
- T**
- T command 827
 - T Option 30
 - Target application 25
 - Target cable 404
 - Target head adapter
 - as additional component 404
 - Target Option 30
 - Tasks
 - Viewing state of 185
 - Term 421
 - Terminal Component 214
 - TESTBOX command 828
 - Text Mode 153
 - Textcolor 153
 - Textual 534
 - Textual display 534
 - Textual menu entry 131
 - Tile menu entry 51
 - Time tag 425
 - Timer Update menu entry 74, 107
 - TMP 855
 - Toolbar
 - Customizing 38
 - Main window 33
 - Toolbar menu entry 38
 - ToolTips Activation 116
 - ToolTips format 116
 - ToolTips menu entry 121
 - ToolTips mode 116
 - Top menu entry 144
 - Top Position is 152
 - Tpd and Tpu Timing Listboxes 335
 - Trace
 - Arming 426
 - Time tag 425
 - Viewing data 426
 - Trace Associated Context menu entries 132
 - Trace component 532
 - Trace Modes 475
 - Trace window 532
 - Traced 533
 - Trigger A 505, 508
 - Trigger address
 - Undefined 529
 - Trigger address editing 529
 - Trigger B 505, 508, 522
 - Trigger Module Settings 504
 - Trigger Module settings 481, 492, 501, 674, 681
 - Trigger stored as markpoints 508
 - Trigger types 514
 - Memory Write Access 530
 - Triggers
 - Expert 518
 - True-Time Simulator and Real-Time Debugger
-

- Configuration 199
- Default Layout Configuration 845
- Demo Version Limitations 26
- Drag and Drop 55
- Engine 25
- Layout 846
- Project 846
- project.ini 845
- Running from a command line 29
- Smart User Interface 54
- Tool tip 33
- User Interface 54
- Using on Windows 2000 199
- TUPDATE command 829
- Type list menu 529
- Type of Unit 152

U

- UDec menu entry 84, 95, 113, 207
- UNDEF command 829
- Undefined trigger address 529
- Unfold All Text menu entry 124
- UNFOLD command 832
- Unfold menu entry 124
- Unfolding 118
 - Mark 118
- Unsecure option 481
- Unsigned Decimal 207
- Unsigned Decimal format 207
- UNTIL command 832
- UPDATERATE command 833
- USBCLR Command 328
- USBOUT Command 330
- USBRESET Command 331
- USELIBPATH 856
- User menu entry 82
- User's Manual 398

V

- Variable
 - Address 208
 - Displaying Format 79
 - Displaying Global Variables 206
 - Displaying Local Variables 205

- Editing Value 208
 - Local and Global 79
 - Mode 82
 - Scope 79
 - Showing Location 209
 - Type 79
 - Value 207
- Variable modification 208
- Vector mirroring setup 492
- VER command 833
- Version number, finding 51
- Vertical Size menu entry 144
- Vertical Text Alignment 153
- View menu 38
- View Register Files 256
- Viewing Code 213
- Viewing data 426
- VisualizationTool
 - 7-Segment Display 150
 - Analog 147
 - Bar Instrument 147
 - Bitmap 148
 - Demo 155
 - Demo limitation 155
 - Demo Version Limitations 155
 - DILSwitch 149
 - Instrument 146
 - Knob 149
 - LED 150
 - Properties 145
 - Switch 151
 - Text 152
- VisualizationTool Component 141
- VisualizationTool Context menu entries 143
- VisualizationTool menu entries 142
- VisualizationTool Properties menu entries 145

W

- W Option 30
- WAIT command 834
- Watchpoint
 - Checking condition 173
 - Command 178
 - Conditional 177, 184

- Counting 176, 184
- Definition 157
- Deleting 178, 184
- Read 174, 182
- Read, Write 158
- Read/Write 175, 183
- Write 175
- Watchpoints 505, 510
- WB command 835
- WHILE command 799, 836
- Width 146
- Window components 61
- Window menu 50, 51
- Window Menu entries 51
- Windows 842
 - Command File 45
- WinEdit 842, 843
- WL command 836
- .WND files 61
- .wnd files 53
- Word menu entry 94
- Word size menu entry 94
- Word Size submenu entries 94
- WorkDir 200
- WorkingDirectory 200
- Write 529
- Write access 510
- Write Access trigger type 514
- WRITEACCESS markpoint type 513
- WW command 837

X

- X-Position 146
- .xpr file 81
- XTAL Command 261

Y

- Y-Position 146

Z

- ZOOM command 838
- Zoom menu entry 82

