



# Motion Control and Robotics

Last Updated: Oct 13, 2023

NXP offers solutions for compact multi-axis motion control all the way up to high-performance robotics applications. Our processing portfolio brings a range of compute capabilities to meet the demands of synchronized and orchestrated movements, including our dual-core i.MX RT crossover MCUs with an integrated Gb time-sensitive networking (TSN) switch for real-time communication and our multicore Layerscape LS processors with multiple integrated connectivity features for low latency and low jitter capabilities. The Layerscape devices also support several operating systems, including Xenomai Linux, a real-time open source OS that provides determinism and real-time control.

## Motion Control and Robotics Block Diagram

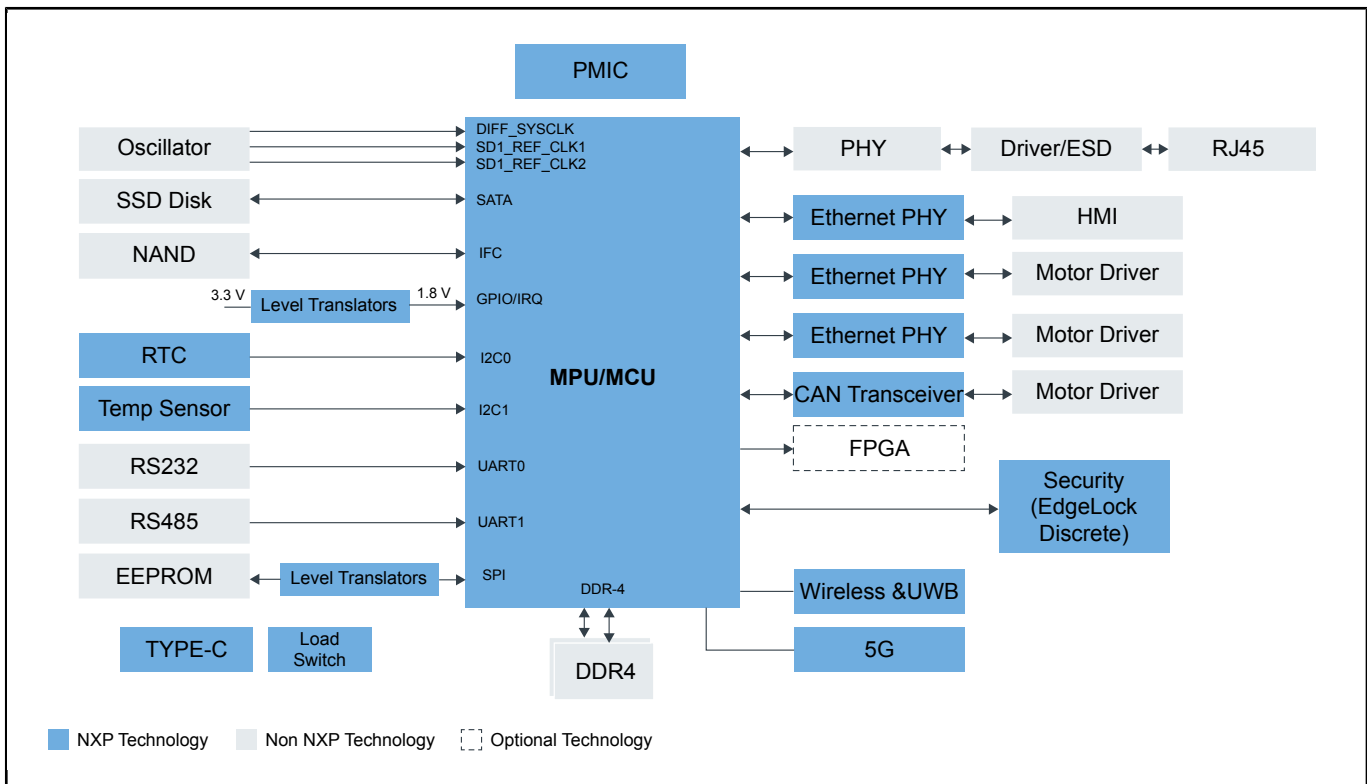

### Recommended Products for Motion Control and Robotics

MPU

\* [LS1046A](#): Layerscape® 1046A and 1026A Processors

	<ul style="list-style-type: none"> <li>• <a href="#">LS1043A</a>: Layerscape® 1043A and 1023A Processors</li> <li>• <a href="#">LS1028A</a>: Layerscape® 1028A Applications Processor</li> <li>• <a href="#">i.MX RT Crossover MCUs</a>: i.MX RT Crossover MCUs</li> </ul>
Voltage Level Translator	<ul style="list-style-type: none"> <li>• <a href="#">Voltage Level Translators</a>: Voltage Level Translators</li> </ul>
Temperature Sensor	<ul style="list-style-type: none"> <li>• <a href="#">P3T1035xUK</a>: I3C, I<sup>2</sup>C-Bus, ±0.5 °C Accuracy, Digital Temperature Sensor</li> <li>• <a href="#">P3T2030xUK</a>: I3C, I<sup>2</sup>C-Bus, 2.0 °C Accuracy, Digital Temperature Sensor</li> <li>• <a href="#">PCT2075</a>: I<sup>2</sup>C-Bus Fm+, 1 Degree C Accuracy, Digital Temperature Sensor and Thermal Watchdog</li> </ul>
RTC	<ul style="list-style-type: none"> <li>• <a href="#">PCF85053A</a>: Bootable CPU RTC with Two I<sup>2</sup>C Buses, 128 Byte SRAM and Alarm Function</li> <li>• <a href="#">Real-Time Clocks</a>: Real-Time Clocks</li> </ul>
CAN Transceiver	<ul style="list-style-type: none"> <li>• <a href="#">CAN with Flexible Data Rate</a>: High Speed CAN with Flexible Data Rate (CAN FD)</li> <li>• <a href="#">CAN Signal Improvement</a>: CAN Signal Improvement Capability (SIC)</li> <li>• <a href="#">Secure CAN Transceivers</a>: Secure TJA115x CAN Transceiver Family</li> </ul>
Security (EdgeLock Discrete)	<ul style="list-style-type: none"> <li>• <a href="#">SE050</a>: EdgeLock® SE050: Plug and Trust Secure Element Family – Enhanced IoT security with high flexibility</li> </ul>
PMIC	<ul style="list-style-type: none"> <li>• <a href="#">MC34VR500</a>: Multi-Output DC/DC Regulator</li> <li>• <a href="#">PCA9410_9410A</a>: 3.0 MHz, 500 MA, DC-to-DC Boost Converter</li> <li>• <a href="#">PF81-PF82</a>: 12-Channel Power Management Integrated Circuit (PMIC) for High-Performance Processing Applications</li> </ul>
Ethernet PHY	<ul style="list-style-type: none"> <li>• <a href="#">Automotive Ethernet PHYs</a>: Automotive Ethernet PHY Transceivers</li> </ul>
Wireless and UWB	<ul style="list-style-type: none"> <li>• <a href="#">88MW32X 802.11n Wi-Fi® Microcontroller SoC</a></li> <li>• <a href="#">IW416</a>: 2.4/5 GHz Dual-Band 1x1 Wi-Fi® 4 (802.11n) + Bluetooth® 5.2 Solution</li> <li>• <a href="#">88W8987</a>: 2.4/5 GHz Dual-Band 1x1 Wi-Fi® 5 (802.11ac) + Bluetooth® 5.2 Solution</li> <li>• <a href="#">QN9090-30</a>: QN9090/30: Bluetooth Low-Energy MCU with Arm®Cortex®-M4 CPU, Energy Efficiency, Analog and Digital Peripherals and NFC Tag Option</li> <li>• <a href="#">KW39-38-37</a>: KW39/38/37: 32-Bit Bluetooth 5.0 Long-Range MCUs with CAN FD and LIN Bus Options, Arm® Cortex®-M0+ Core</li> <li>• <a href="#">Ultra-Wideband (UWB)</a>: Ultra wideband (UWB)</li> </ul>
5G	<ul style="list-style-type: none"> <li>• <a href="#">5G Access Edge Technologies</a>: 5G Access Edge Technologies</li> </ul>
Load Switch	<ul style="list-style-type: none"> <li>• <a href="#">NX5P3090UK</a>: USB PD and Type-C Current-Limited Power Switch</li> </ul>
USB Type-C	<ul style="list-style-type: none"> <li>• <a href="#">PTN5150</a>: CC Logic for USB Type-C Applications</li> <li>• <a href="#">NX20P0477</a>: USB Type-C CC Smart Protection</li> </ul>

View our complete solution for [Motion Control and Robotics](#).

**Note:** The information on this document is subject to change without notice.

**[www.nxp.com](http://www.nxp.com)**

NXP and the NXP logo are trademarks of NXP B.V. All other product or service names are the property of their respective owners. The related technology may be protected by any or all of patents, copyrights, designs and trade secrets. All rights reserved. © 2024 NXP B.V.