

WCT1001A/WCT1003A V4.0 Run-Time Debugging User's Guide

1 Read Me First

The FreeMASTER GUI tool is provided for the WCT1001A/WCT1003A Automotive A13 wireless charging solution. The GUI based on the FreeMASTER tool can be used to fine tune the parameters in running state. For the operations of setting up the FreeMASTER connection, see the *WCT1001A/WCT1003A Automotive A13 V4.0 Wireless Charging Application User's Guide* (WCT100XAV40WCAUG).

Contents

1	Read Me First	1
2	Run-Time Tuning and Debugging	2
3	Configuration Structure Reference	17
4	Revision History	54



2 Run-Time Tuning and Debugging

2.1 NVM parameters

This chapter describes the configuration and tuning of the WCT library. The main configuration structure of the library is initially stored in the Flash memory from where it is copied to NvmParams structure in RAM. The initialization data for the Flash-memory structure are stored in the `EEdata_FlashDefaults.asm` file.

The WCT GUI based on the FreeMASTER tool can be used to fine tune the parameters at run-time. The same GUI may also be used to generate the assembler initialization data for the Flash-based configuration. Alternatively, the WCT GUI may also be used to trigger the application to backup the actual RAM content of the data structure to Flash.

Section 3 “Configuration Structure Reference” provides detailed information about each configuration parameter. The same reference information is also available directly in the GUI tool where the parameters can be changed at run-time.

2.1.1 Run-Time access to NVM parameters

As outlined in the previous sections, the WCT GUI based on FreeMASTER tool can be used to read and modify the parameters in run-time. Modification of the parameters is performed immediately, so any change in the behavior of the Wireless Charging system can be evaluated instantly.

The GUI also enables to restore all configuration parameters to their default values or synchronize the configuration in GUI with board values by pressing a single button.

The parameters are split to several tabs in the GUI view:

- System parameters
- Coil Parameters
- Calibration

To make the fine-tuned configuration values permanent and default for the next application build, the whole structure can be exported into assembler syntax of initialization data block. The generated data can be put to `EEdata_FlashDefaults.asm` file directly and used as a new default configuration set.

In addition to actual configuration values, the GUI also calculates proper checksum values in order to make the data block valid for use by the Wireless Charging library.

The exported initialization data block is available on the *NVM Raw* tab in the GUI.

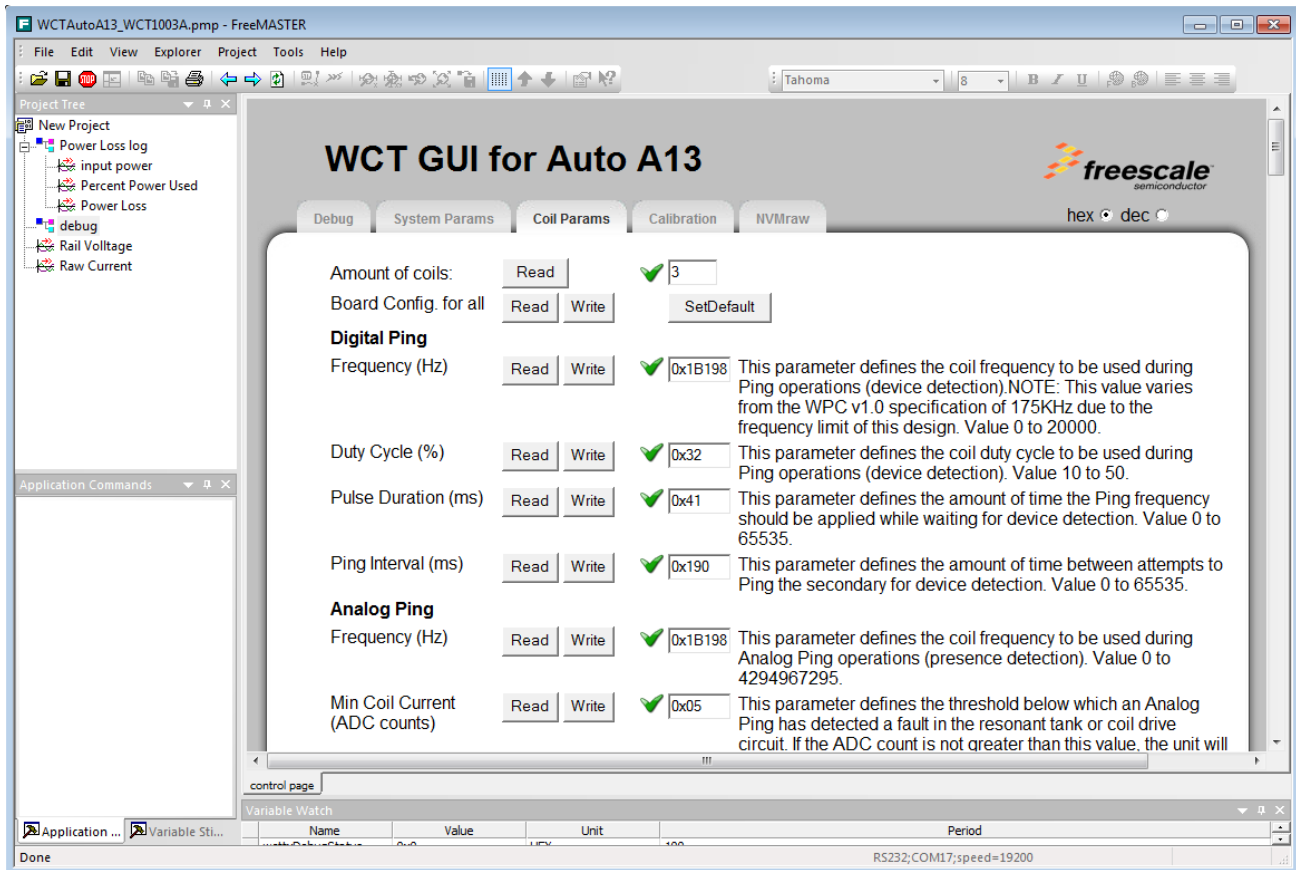

Figure 1 WCT GUI (1)

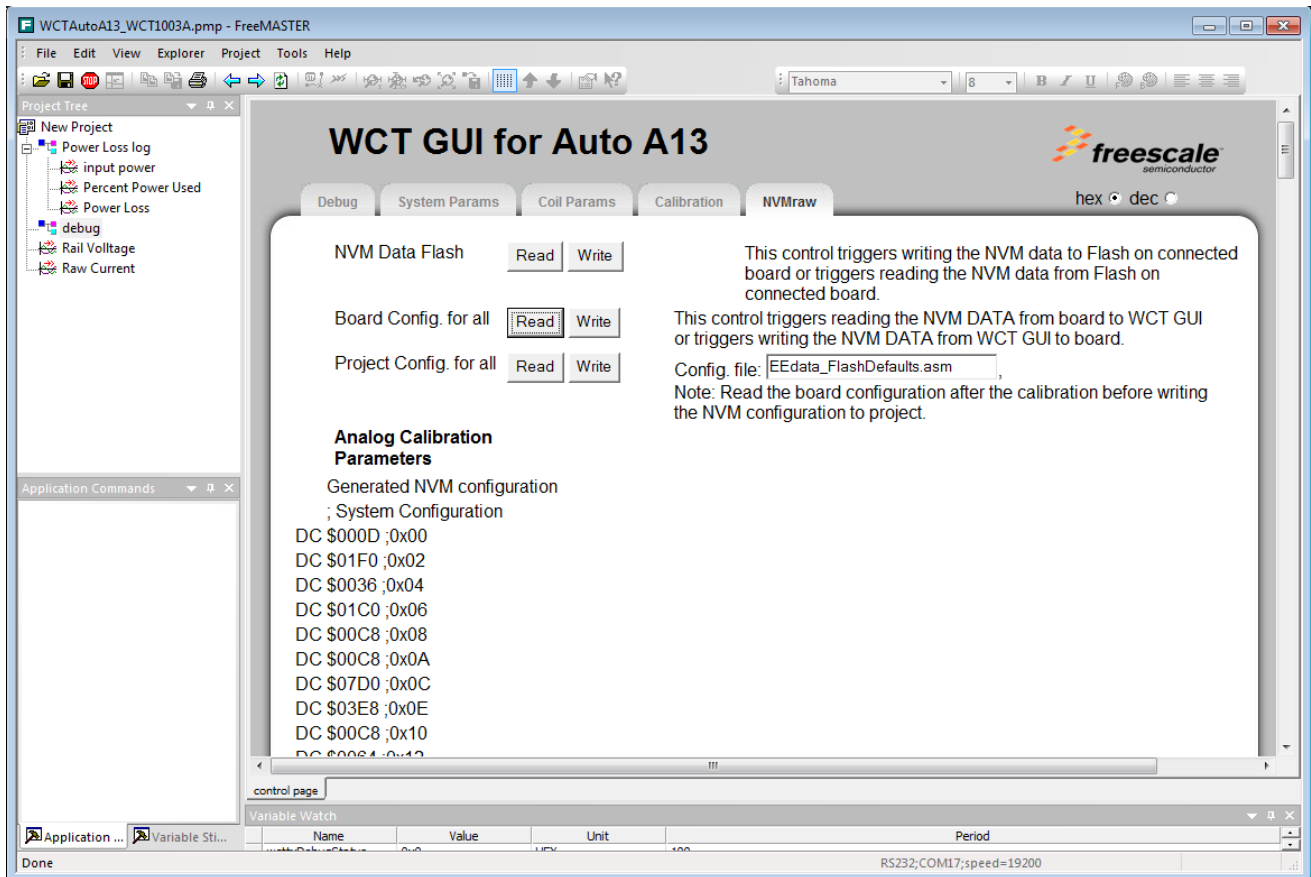

Figure 2 WCT GUI (2)

2.2 Tuning and debugging

The library is used together with the FreeMASTER visualization tool to calibrate input values and to observe behavior of the Wireless Charging transmitter. The FreeMASTER tool connects to the target board by using the UART, JTAG, or CAN communication interface.

2.2.1 Data visualization

The FreeMASTER tool enables visualization of any variables or registers in the application running on the target system. This feature is particularly useful with Wireless Charging application to observe voltage and currents in real time by using a graphical representation.

The FreeMASTER project file which comes in the Library package contains pre-configured Scope views with the most frequently used run-time parameters. The graphs and views can be easily extended by more parameters or user-defined data.

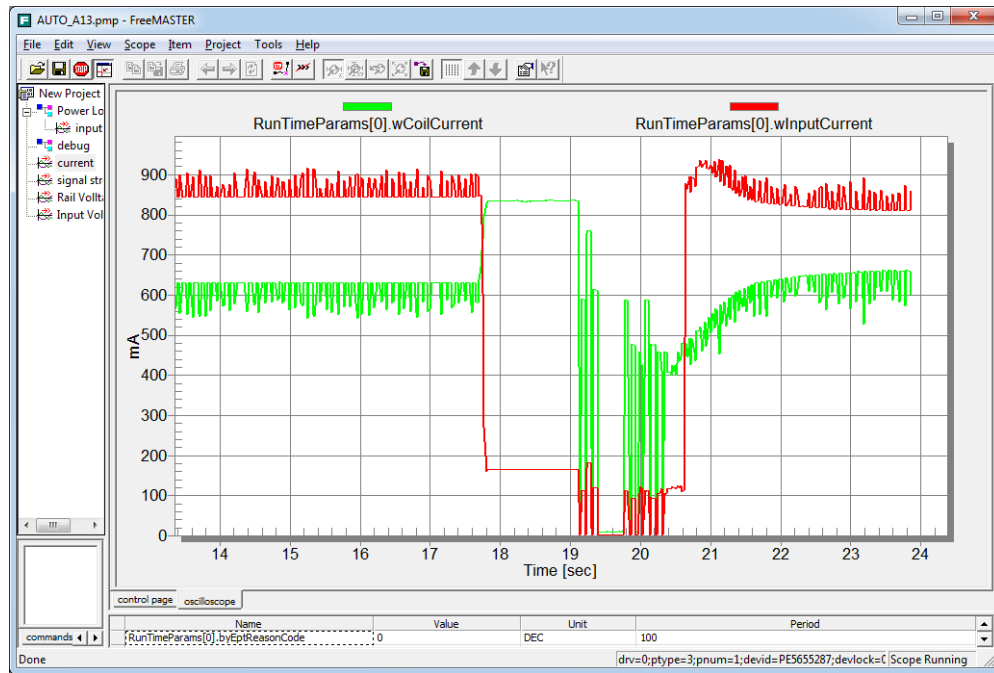

Figure 3 Data visualization

2.2.2 Debug console

In addition to FreeMASTER visualization, the WCT library provides an option to continuously dump selected debug information to user console over the UART interface. The debug messages are sent to UART any time an important event occurs if the appropriate message type is enabled.

Be aware that the console UART port must be different from the UART port used by the FreeMASTER communication. If only one UART port is available, an alternative communication interface can be used for the FreeMASTER connection. In addition to UART, FreeMASTER also supports the CAN or JTAG cable interface.

2.3 Calibration

The library behavior and its parameters should be calibrated before the library can be successfully used. The calibration procedure consists of four steps, namely, rail voltage calibration, input current calibration, characterization parameters calibration, and normalization parameters calibration. All the steps require low power disabled, touch disabled, and library running in debug mode except normalization parameters calibration.

All the calibration steps are used to get accurate power loss for Foreign Object Detection (FOD). Power loss can be calculated by the following equation. If P_{Loss} is bigger than threshold, there must be an foreign object.

$$P_{Loss} = T_{IN} - T_{Loss} - R_{IN}$$

- **Rail Voltage Calibration** and **Input Current Calibration** are used to get accurate T_{IN} .
- **Characterization Parameters Calibration** is used to estimate T_{Loss} .
- **Normalization Parameters Calibration** is used to get accurate R_{IN} .

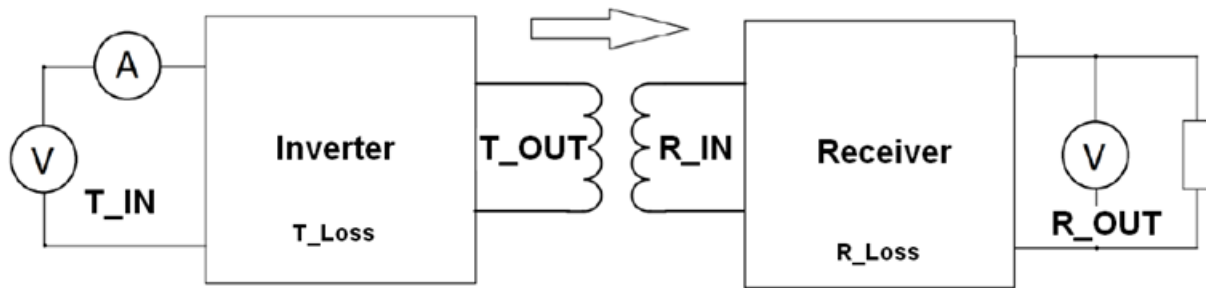

Figure 4 Calibration

2.3.1 Rail voltage calibration

The process of rail voltage calibration is as follows:

1. Power on the wireless charging transmitter board with the receiver (Rx) powered off.
2. If Touch Sensing is not used, go to Step 3.
Otherwise, avoid putting the system to sleep. Scroll down to the lower part of the window, write 255 to **byTouchTimeout**, touch the Touch Sensing Board with your finger, and press **Enter** on your keyboard.

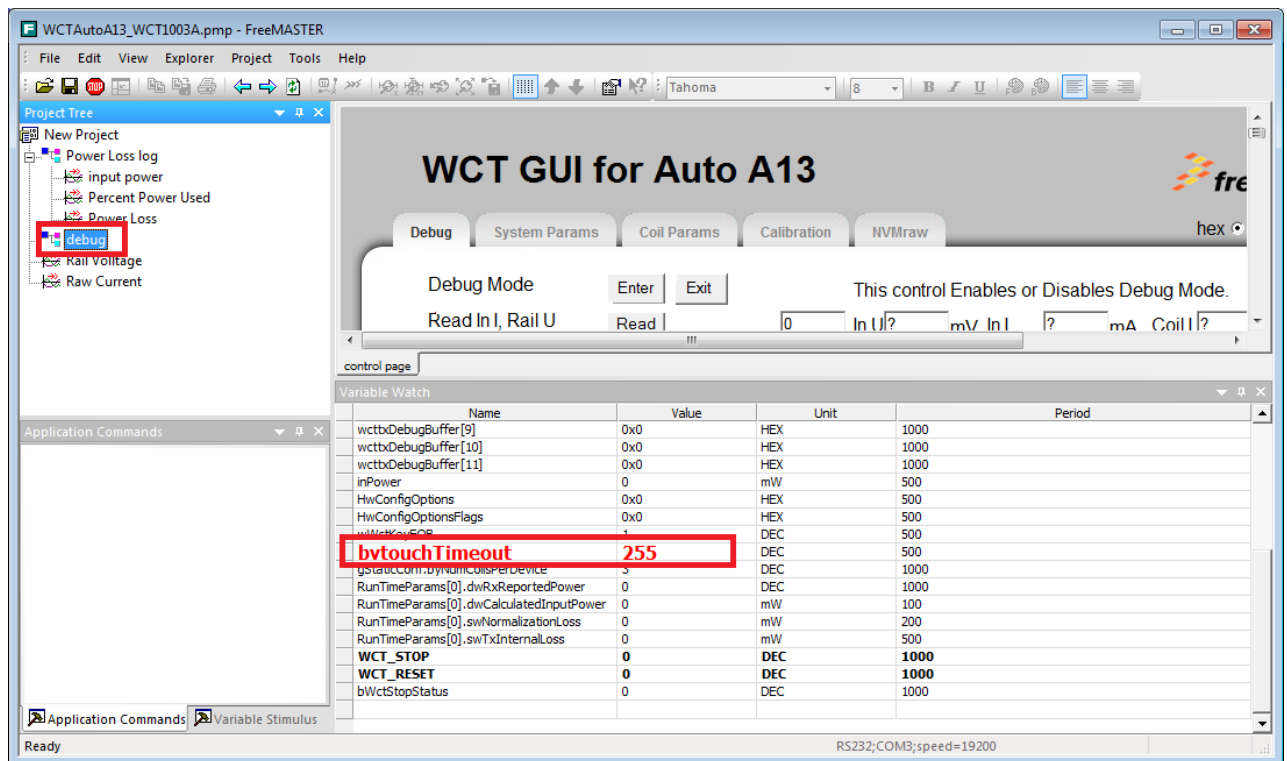

Figure 5 Writing 255 to byTouchTimeout

- In the **Rail Voltage Calibration** area, click **Reset** and **Enter**.

Rail Voltage Calibration

- 1) Set Device ID:
- 2) Set the calibration constant to default before calibration: ✓
- 3) Enter to debug mode: ✓
- 4) Read Voltage by processor mV
- 5) Measure Voltage by multimeter mV
- 6) Move Calibration Constant to NVM:
- 7) Save final calibration constant to FLASH:
- 8) Disconnect FreeMASTER and reset CPU

Figure 6 Entering the Debug mode

- Write **3000** to **DAC Control**. In this case the rail voltage is around 4.5V and the value is similar to the one in charging mode.

WCT GUI for Auto A13

freescaler semiconductor

hex dec

Debug System Params Coil Params Calibration NVMraw

Debug Mode This control Enables or Disables Debug Mode.

Read In I, Rail U In U? mV, In I mA, Coil I mA
In P? mW, Tx loss? mW, Out P? mW

Rail Voltage Calibr. This control Calibrate Rail Voltage. Result is in sdwRailVoltageSlope, sdwRailVoltageOffset and wRailVoltageNorm

Rail Voltage Control Rail Voltage of desired ID: mV.

Coil Frequency Coil Frequency of desired Coil ID: Hz.

Coil Discharge Enables or disables Coil Discharge.

Coil Duty Cycle Coil Duty Cycle of desired Coil ID: %, Note: Frequency must be set first..

Batery Switch This control Enables or Disables batery Switch

DAC Control ✓ DAC output of desired ID: Counts.

PMAT Switch This control Enables or Disables PowerMat Switch

Figure 7 Writing 3000 to DAC Control

- Measure the Rail Voltage on the board (TP4).
- In the **Rail Voltage Calibration** area, click **Read**, enter the measured voltage, and then click **Move** and **Save**.

Rail Voltage Calibration

- 1) Set Device ID:
- 2) Set the calibration constant to default before calibration: ✓
- 3) Enter to debug mode: ✓
- 4) Read Voltage by processor: ✓ mV
- 5) Measure Voltage by multimeter: mV
- 6) Move Calibration Constant to NVM: ✓
- 7) Save final calibration constant to FLASH: ✓
- 8) Disconnect FreeMASTER and reset CPU

Figure 8 Rail voltage calibration

7. Read out the rail voltage calibration constant on the **Calibration** page of the FreeMASTER GUI to ensure that it is saved successfully. Then disconnect FreeMASTER and power down.

Input Voltage Calibration Constant (100% = 32768)	<input type="button" value="Read"/> <input type="button" value="Write"/>	✓ <input type="text" value="0x7D6A"/> Indicates the calibration error for the ADC reading of Input Voltage. A value of 77% (translated to a parameter value of 25231) indicates that the actual value of the Input Voltage is 77% of the reported ADC value for the system. Value 0 to 65535.
---	---	---

Figure 9 Reading out the rail voltage calibration constant

2.3.2 Input current calibration

The process of input current calibration is as follows:

1. Power on the board without Rx and disable touch sensing, similar as step 2 in Section 2.3.1 “Rail voltage calibration”.
2. Click **Reset**, **Enter** and **Calibr.**

Input Current Calibration

- 1) Set device ID:
- 2) Set the calibration constant to default before calibration: ✓
- 3) Enter to debug mode: ✓
- 4) Run Rail Voltage calibration: ✓
- 5) Measure the input current for different loads connected to Half Bridge on transmitter

Figure 10 Input Current Calibration

3. Plug the electronic load or resistors between TP7 and ground after Step 2. Otherwise, the input current cannot be read correctly.

4. Measure the actual current through the load by a multimeter and fill actual value in the **Real I** column. Then click **Read**. Change load current from 50 mA to 2000 mA. Repeat for all the other rows and then click **Move** and **Save**.

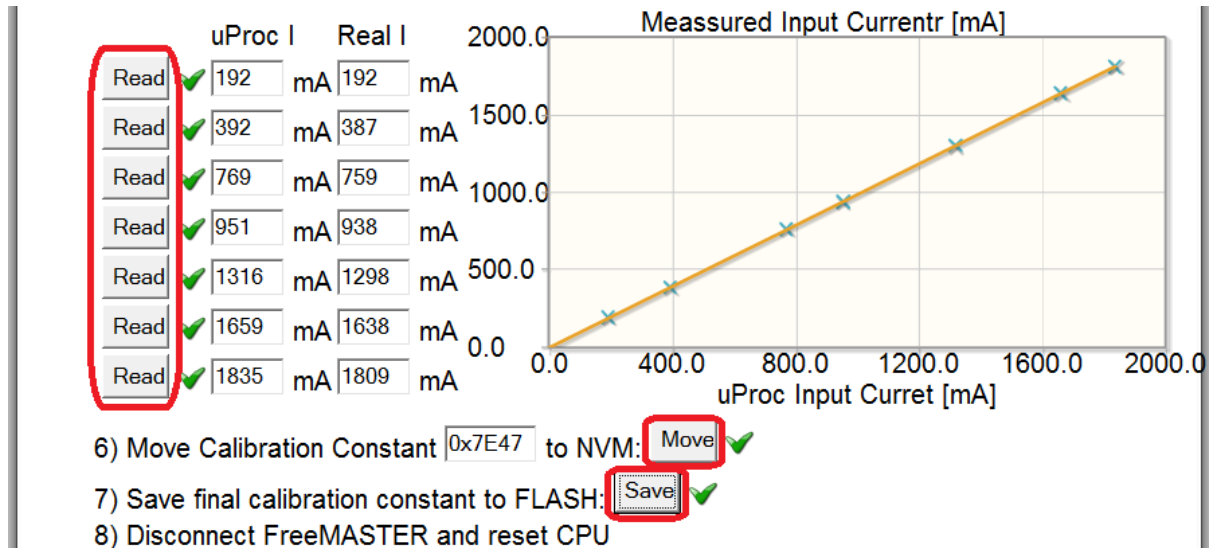

Figure 11 Setting the current values

5. Read out the input current calibration constant on the **Calibration** page of the FreeMASTER GUI to ensure that it is saved successfully. Then disconnect FreeMASTER and power down.

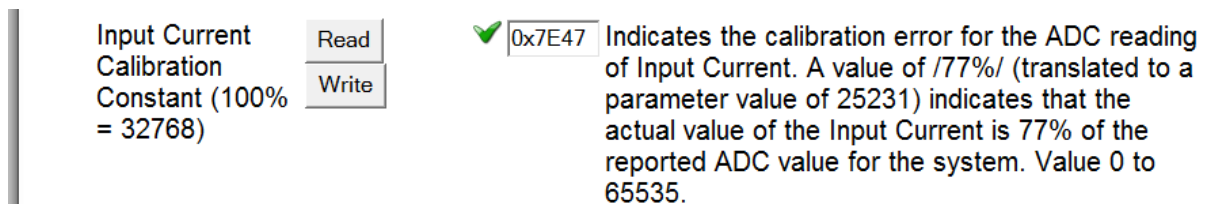

Figure 12 Reading out the input current calibration constant

2.3.3 Characterization parameters calibration

1. Power on the board without Rx and disable the touch sensing, similar as step 2 in Section 2.3.1 “Rail voltage calibration”.
2. Click **Read** on the **Coil Params** page to check how many coils the library supports before doing the following calibration. If the number of coils is more than 3, the FreeMASTER GUI can dynamically extend the number of the calibration parameters according to the number of the coils.

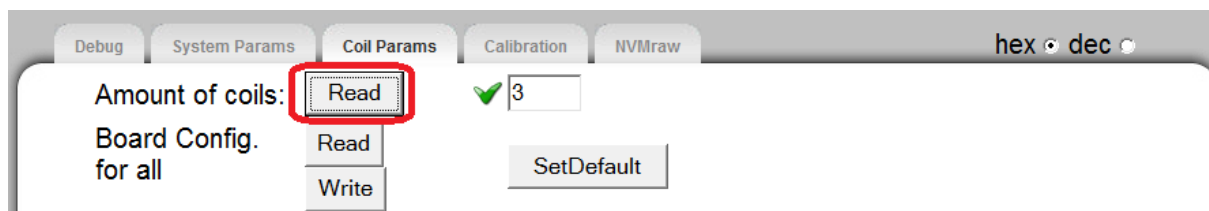

Figure 13 Clicking Read on the Coil Params page

- Enter the Coil ID, click **Enter** and **On**, and then click **Set** and **Read** for each row. Then press **Off**, **Move**, and **Save**.

FOD Calibration of characterisation parameters

- Set Device ID: and Coil ID
- Enter to debug mode
- Turn On desired coil:
- Read the coil current and input power for different configuration of the Rail Voltage

Rail Volt. [V]	Coil I	Input Power
<input type="button" value="Set"/> 3 <input type="button" value="Read"/>	<input type="text" value="0.996"/> A <input type="text" value="174"/> mW	1600.0
<input type="button" value="Set"/> 3.5 <input type="button" value="Read"/>	<input type="text" value="1.412"/> A <input type="text" value="232"/> mW	1400.0
<input type="button" value="Set"/> 4 <input type="button" value="Read"/>	<input type="text" value="2.4"/> A <input type="text" value="465"/> mW	1200.0
<input type="button" value="Set"/> 4.5 <input type="button" value="Read"/>	<input type="text" value="3.3"/> A <input type="text" value="760"/> mW	1000.0
<input type="button" value="Set"/> 5 <input type="button" value="Read"/>	<input type="text" value="4.05"/> A <input type="text" value="1080"/> mW	800.0
<input type="button" value="Set"/> 5.5 <input type="button" value="Read"/>	<input type="text" value="4.64"/> A <input type="text" value="1402"/> mW	600.0
<input type="button" value="Set"/> 6 <input type="button" value="Read"/>	<input type="text" value="0"/> A <input type="text" value="0"/> mW	400.0
<input type="button" value="Set"/> 6.5 <input type="button" value="Read"/>	<input type="text" value="0"/> A <input type="text" value="0"/> mW	200.0
<input type="button" value="Set"/> 7 <input type="button" value="Read"/>	<input type="text" value="0"/> A <input type="text" value="0"/> mW	0.0
<input type="button" value="Set"/> 7.5 <input type="button" value="Read"/>	<input type="text" value="0"/> A <input type="text" value="0"/> mW	0.0

- Turn off desired coil
- Tune calculated constants: C5 , C5 Exp , C6 , C6 Exp , C7
- Move FOD Calibration Constants to NVM:
- Save final calibration constant to FLASH:
- Disconnect FreeMASTER and reset CPU

Figure 14 Setting the Coil ID

- Read out the **PLD/FOD Characterization Parameters** on the **Calibration** page of the FreeMASTER GUI to ensure that it is saved successfully.

PLD / FOD Characterization Parameters - Coil 0			
C5 - Quadratic Coefficient (mW/mA ² x 2 ^{N5})	<input type="button" value="Read"/>	<input type="button" value="Write"/>	<input checked="" type="checkbox"/> 0x5E36 This parameter defines the quadratic coefficient of the equation used to calculate Tx losses represented in units of mW/mA ² multiplied by the value of 2 ^{N5} , where N5 is the exponent defined by the next parameter. Value -32768 to 32767.
C5 Exponent (N5)	<input type="button" value="Read"/>	<input type="button" value="Write"/>	<input checked="" type="checkbox"/> 0x1D This parameter is the value of the exponent used to scale the C5 coefficient to obtain an integer value in units of mW/mA ² . Value 0 to 65535.
C6 - Linear Coefficient (mW/mA x 2 ^{N6})	<input type="button" value="Read"/>	<input type="button" value="Write"/>	<input checked="" type="checkbox"/> 0x595A This parameter defines the linear coefficient of the equation used to calculate Tx losses represented in units of mW/mA multiplied by the value of 2 ^{N6} , where N6 is the exponent defined by the next parameter. Value -32768 to 32767.
C6 Exponent (N6)	<input type="button" value="Read"/>	<input type="button" value="Write"/>	<input checked="" type="checkbox"/> 0x12 This parameter is the value of the exponent used to scale the C6 coefficient to obtain an integer value in units of mW/mA. Value 0 to 65535.
C7 - Constant Term (mW)	<input type="button" value="Read"/>	<input type="button" value="Write"/>	<input checked="" type="checkbox"/> 0x06 This parameter represents the constant term of the equation used to calculate Tx losses (represented in mW). This value equates to the static losses of the FET drive circuitry. Value -32768 to 32767.
Power Loss Calibration Offset (mW)	<input type="button" value="Read"/>	<input type="button" value="Write"/>	<input checked="" type="checkbox"/> 0x00 This parameter represents the offset to be used with the calculation of system Power Loss to prevent negative results due to resolution on reported RX power received, curve-fit and other calibration errors. Value -30000 to 30000.

Figure 15 PLD/FOD Characterization Parameters

- Repeat Step 3 and Step 4 for the remaining IDs (0-2, when coil number is 3).
- Disconnect FreeMASTER and power down.

2.3.4 Normalization parameters calibration

- Make sure that the rail voltage, input current, and characterization parameters calibration are configured.
- Power on and disable the touch sensing, similar as step 2 in Section 2.3.1 “Rail voltage calibration”.
- Enter the Coil ID, click **Reset** and **Exit**.
- Place the AVID Qi FOD Receiver on the selected coil. Change the load of the Receiver in the range from 0 mW to 5000 mW and click **Read** for each row. Wait a second before clicking **Read** to stabilize the Rx. If the receiver is not charged with higher loads, leave the last chargeable load and click **Read** on the remaining rows. Make sure that all the 10 rows must be read. Then click **Move** and **Save**.

FOD Calibration of normalisation parameters

- 1) Set Device ID: and Coil ID:
- 2) Set the FOD Normalisation parameters to default before the calibration:
- 3) Exit debug mode:
- 4) Put calibrated receiver on coil and Read the output power for different loads of RX

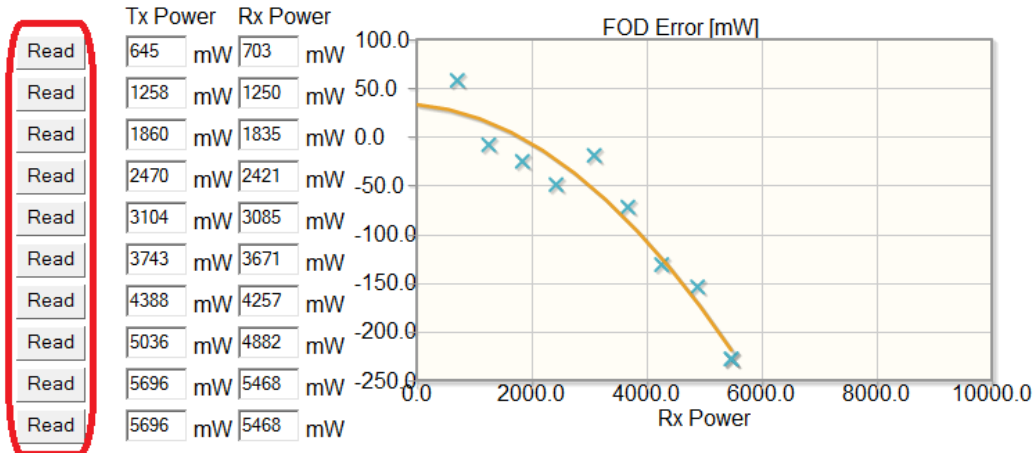

- 5) Tune calculated constants: CA1 , CA1 Exp , CA2 , CA2 Exp , CA3
- 6) Tune calculated constants:!!todo!! CB1 , CB1 Exp , CB2 , CB2 Exp , CB3
- 7) Move FOD Calibration Constants to NVM: todo
- 10) Save final calibration constant to FLASH:
- 11) Disconnect FreeMASTER and reset CPU

Figure 16 FOD calibration of normalization parameters

5. Read out the **PLD/FOD Normalization Parameters** on the **Calibration** page of the FreeMASTER GUI to ensure that it is saved successfully.

PLD / FOD Normalization Parameters - Coil 0

CA1 - Quadratic Coefficient for region A (mW/mW ² x 2 ^{NA1})	<input type="button" value="Read"/> <input type="button" value="Write"/>	<input checked="" type="checkbox"/>	<input type="text" value="0x8238"/>	This parameter defines the quadratic coefficient of the equation used to calculate the normalization for system power losses represented in units of mW/mW ² multiplied by the value of 2 ^{NA1} , where NA1 is the exponent defined by the next parameter. Value -32768 to 32767.
CA1 Exponent (NA1)	<input type="button" value="Read"/> <input type="button" value="Write"/>	<input checked="" type="checkbox"/>	<input type="text" value="0x20"/>	This parameter is the value of the exponent used to scale the CA1 coefficient to obtain an integer value in units of mW/mW ² . Value 0 to 65535.
CA2 - Linear Coefficient for region A (mW/mW x 2 ^{NA2})	<input type="button" value="Read"/> <input type="button" value="Write"/>	<input checked="" type="checkbox"/>	<input type="text" value="0xABE7"/>	This parameter defines the linear coefficient of the equation used to calculate the normalization for system power losses represented in units of mW/mW multiplied by the value of 2 ^{NA2} , where NA2 is the exponent defined by the next parameter. Value -32768 to 32767.
CA2 Exponent (NA2)	<input type="button" value="Read"/> <input type="button" value="Write"/>	<input checked="" type="checkbox"/>	<input type="text" value="0x16"/>	This parameter is the value of the exponent used to scale the CA2 coefficient to obtain an integer value in units of mW/mW. Value 0 to 65535.
CA3 - Constant Term for region A (mW)	<input type="button" value="Read"/> <input type="button" value="Write"/>	<input checked="" type="checkbox"/>	<input type="text" value="0x21"/>	This parameter represents the constant term of the equation used to calculate the normalization for system power losses (represented in mW). Value -32768 to 32767.

Figure 17 PLD/FOD Normalization Parameters

6. Repeat Steps 3, 4, 5, and 6 for the remaining IDs.
7. Disconnect FreeMASTER and power down.

Now all calibration is done. The user can power on the board and charge.

2.4 Moving the NVM data to the CW project

After the calibration is done, if you want to preserve the calibrated data or some changes done in the GUI for next flashing, you can copy the NVM data directly to the project in the CodeWarrior.

1. Click **Read** on the **Coil Params** page to extend the calibration parameters and coil default rail voltage according to the number of the coils when the number is more than 3.

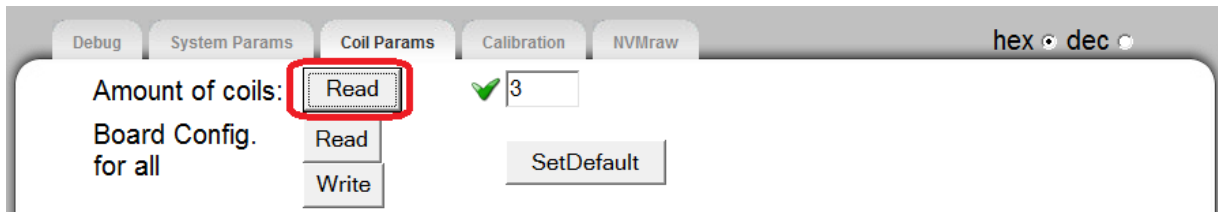

Figure 18 Clicking Read on the Coil Params page

2. Click **Read** next to **Board Config. for all**. All the NVM data from the board are displayed.

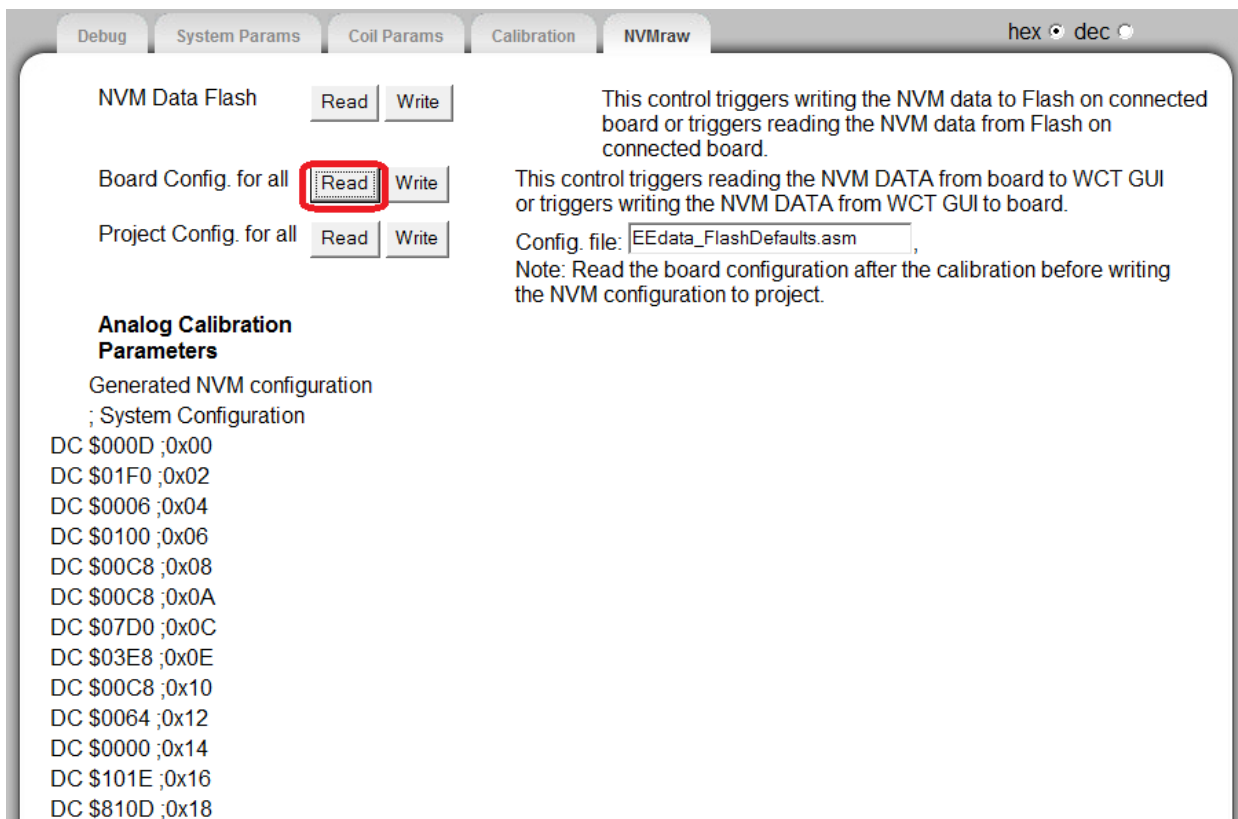

Figure 19 Displaying all the NVM data

- Write the NVM data to **EEdata_FlashDefaults.asm**. This feature is supported by the FreeMASTER tool v1.4 or later. After you click **Write**, CodeWarrior prompts that the **EEdata_FlashDefaults.asm** file has been replaced. Then click **Yes** and rebuild the project for next flashing.

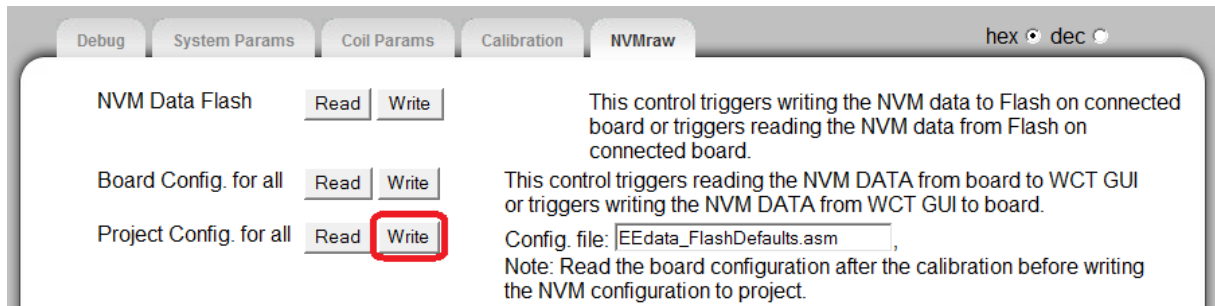

Figure 20 Writing the NVM data to EEdata_FlashDefaults.asm

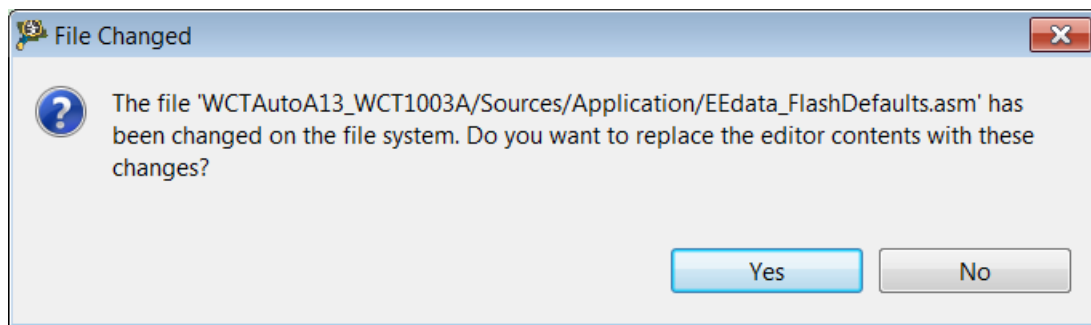

Figure 21 File updating result

2.5 DDM tuning and debugging

Figure 22 shows the diagram for the Qi/PMA communication decoder with digital demodulation.

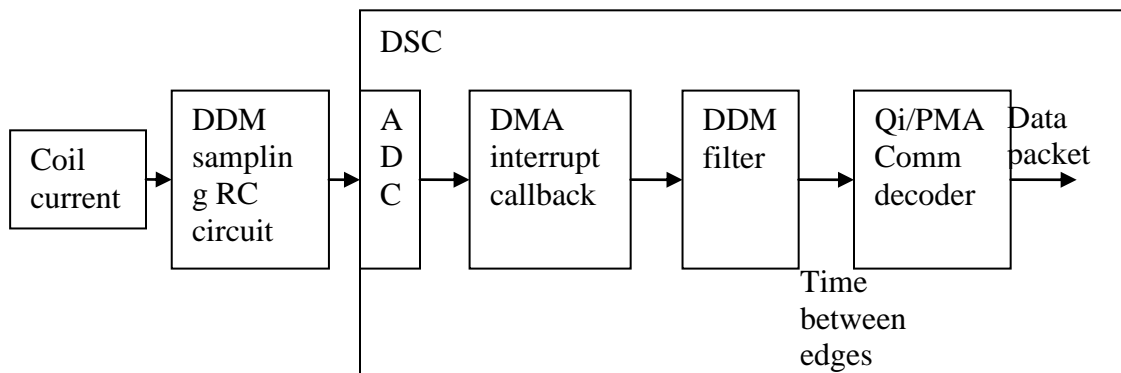

Figure 22 Qi communication decoder with digital demodulation

Figure 23 shows the DDM sampling RC circuit.

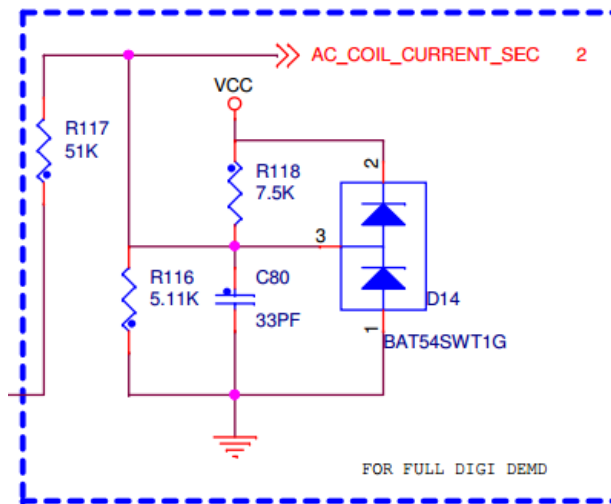

Figure 23 DDM sampling RC circuit

The peripheral settings are as follows:

- ADC is triggered synchronously with PWM.
- TMRA0 is triggered when 128 ADC samples are obtained (which is served as DMA interrupt).

2.5.1 Presumption on the coil current waveform

During experimentation, it was found that the minimum value or valley of coil current appears in the first 30% of the duration. Therefore, to improve efficiency, we search the valley of coil current in [0, 30%] range of the waveform duration (check `DDM_SetBestTriggerPos()` in `wct_hal.c`). Make sure that this presumption is valid on real board.

If not, contact the development team in NXP to check the hardware.

2.5.2 Coil current signal quality check

DDM uses sampled coil current data to decode communication packets or symbols from RX, so the sampled data impacts the DDM decoding quality much. Because the coil current is sampled synchronously with the PWM signal, when there is no RX on the TX surface (the coil current is without modulation), ideally the sampled data is of the same value when the circuit is working stably. But in reality, the sampled data has some variance.

We provide a tool in the Freemaster GUI to evaluate the coil current signal quality visually. It is actually the histogram of the measured data. The following is an example showing the coil current data histogram measured on the WCT100xA reference board.

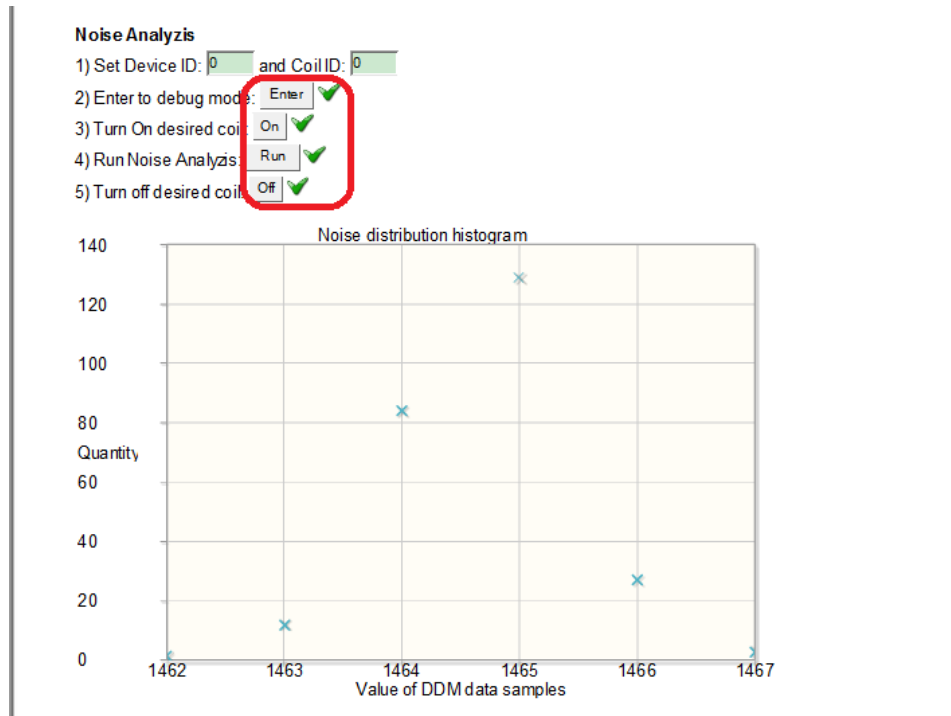

Figure 24 Noise analysis

2.5.3 Software

When DMA interrupt (TMRA0) is generated, `WCT_WpcDDMDataAnalyze()` and `WCT_PmaDDMDataAnalyze()` are called. It is the "DDM filter" in the above diagram. Its output is the time interval between edges.

The time edge data is processed by the Qi communication decoder.

2.5.4 How to debug

Make sure that the coil current to the ADC module is correct. You can see the amplitude modulation on the signal.

Make sure that the TMRA0 (DMA) interrupt is triggered periodically.

Set `"gStaticConf.wctdbg_cfg.commpacketdbg = 1"` in `main()`, so that if a data packet is received correctly, the packet data is printed.

3 Configuration Structure Reference

3.1 System parameters

LED1 Operation ON/OFF Bitfield

Details:

This parameter configures On/Off behavior of LED1 diode

Bit0 – This parameter, when set, indicates LED1 should be ON in the Initialization state.

Bit1 – This parameter, when set, indicates LED1 should be ON in the STANDBY state.

Bit2 – This parameter, when set, indicates LED1 should be ON in the Power Xfer state.

Bit3 – This parameter, when set, indicates LED1 should be ON in the Device Charged state.

Bit4 – This parameter, when set, indicates LED1 should be ON in the FOD Fault state.

Bit5 – This parameter, when set, indicates LED1 should be ON in the Device Fault state.

Bit6 – This parameter, when set, indicates LED1 should be ON in the System Fault state.

Bit7 – This parameter, when set, indicates LED1 should be ON in the NVM Fault state.

Bit8 – This parameter, when set, indicates LED1 should be ON for the LED ON diagnostic cmd.

Bit9 – This parameter, when set, indicates LED1 should be ON for the LED OFF diagnostic cmd.

Default Value: 0x000D

Member: NvmParams.SystemParams.LedOperation.LedParams[0].wLedOnOffStateBitfield.all

LED1 Operation Blink Bitfield

Details:

This parameter configures Blinking behavior of LED1 diode

Bit0 – This parameter, when set, indicates LED1 should be ON in the Initialization state.

Bit1 – This parameter, when set, indicates LED1 should be ON in the STANDBY state.

Bit2 – This parameter, when set, indicates LED1 should be ON in the Power Xfer state.

Bit3 – This parameter, when set, indicates LED1 should be ON in the Device Charged state.

Bit4 – This parameter, when set, indicates LED1 should be ON in the FOD Fault state.

Bit5 – This parameter, when set, indicates LED1 should be ON in the Device Fault state.

Bit6 – This parameter, when set, indicates LED1 should be ON in the System Fault state.

Bit7 – This parameter, when set, indicates LED1 should be ON in the NVM Fault state.

Bit8 – This parameter, when set, indicates LED1 should be ON for the LED ON diagnostic cmd.

Bit9 – This parameter, when set, indicates LED1 should be ON for the LED OFF diagnostic cmd.

Default Value: 0x01F0

Member: NvmParams.SystemParams.LedOperation.LedParams[0].wLedBlinkStateBitfield.all

LED2 Operation ON/OFF Bitfield

Details:

This parameter configures On/Off behavior of LED2 diode

Bit0 – This parameter, when set, indicates LED1 should be ON in the Initialization state.

Bit1 – This parameter, when set, indicates LED1 should be ON in the STANDBY state.

Bit2 – This parameter, when set, indicates LED1 should be ON in the Power Xfer state.

Bit3 – This parameter, when set, indicates LED1 should be ON in the Device Charged state.

Bit4 – This parameter, when set, indicates LED1 should be ON in the FOD Fault state.

Bit5 – This parameter, when set, indicates LED1 should be ON in the Device Fault state.

Bit6 – This parameter, when set, indicates LED1 should be ON in the System Fault state.

Bit7 – This parameter, when set, indicates LED1 should be ON in the NVM Fault state.

Bit8 – This parameter, when set, indicates LED1 should be ON for the LED ON diagnostic cmd.

Bit9 – This parameter, when set, indicates LED1 should be ON for the LED OFF diagnostic cmd.

Default Value: 0x36

Member: NvmParams.SystemParams.LedOperation.LedParams[1].wLedOnOffStateBitfield.all

LED2 Operation Blink Bitfield

Details:

This parameter configures Blinking behavior of LED1 diode

Bit0 – This parameter, when set, indicates LED1 should be ON in the Initialization state.

Bit1 – This parameter, when set, indicates LED1 should be ON in the STANDBY state.

Bit2 – This parameter, when set, indicates LED1 should be ON in the Power Xfer state.

Bit3 – This parameter, when set, indicates LED1 should be ON in the Device Charged state.

Bit4 – This parameter, when set, indicates LED1 should be ON in the FOD Fault state.

Bit5 – This parameter, when set, indicates LED1 should be ON in the Device Fault state.

Bit6 – This parameter, when set, indicates LED1 should be ON in the System Fault state.

Bit7 – This parameter, when set, indicates LED1 should be ON in the NVM Fault state.

Bit8 – This parameter, when set, indicates LED1 should be ON for the LED ON diagnostic cmd.

Bit9 – This parameter, when set, indicates LED1 should be ON for the LED OFF diagnostic cmd.

Default Value: 0x1C0

Member: NvmParams.SystemParams.LedOperation.LedParams[1].wLedBlinkStateBitfield.all

Fault Blink Rate (ms)

Details:

This parameter represents the period of time used to establish a blink rate for any LED in a SYSTEM FAULT or DEVICE FAULT condition.

Default Value: 200

Min Value: 0

Max Value: 65535

Member: NvmParams.SystemParams.LedOperation.wFaultBlinkRateMs

FOD Fault Blink Rate (ms)

Details:

This parameter represents the period of time used to establish a blink rate for any LED in a FOD FAULT condition.

Default Value: 200

Min Value: 0

Max Value: 65535

Member: NvmParams.SystemParams.LedOperation.wModFaultBlinkRateMs

Operational State Blink Rate (ms)

Details:

This parameter represents the period of time used to establish a blink rate for any LED when the system is in a non-fault state.

Default Value: 2000

Min Value: 0

Max Value: 65535

Member: NvmParams.SystemParams.LedOperation.wOpStateBlinkRateMs

Delay At Power-Up (ms)

Details:

This parameter can be used to “hold” the state of the LED(s) following initial power-up of the system.

Default Value: 1000

Min Value: 0

Max Value: 65535

Member: NvmParams.SystemParams.LedOperation.wDelayAtPowerUpMs

Default PWM Dead Time (ns)

Details:

This parameter defines the default dead time that is used for PWM outputs when configured for use with a standard FET driver.

Default Value: 200

Min Value: 0

Max Value: 65535

Member: NvmParams.SystemParams.OpStateParams.wPwmDeadTimeNs

Keyfob Avoidance Duration (ms)

Details:

This parameter defines the length of time the unit operates at the Keyfob Avoidance Frequency after being triggered by the IO control signal. This value is ignored if the Keyfob Avoidance Duration Based on IO parameter is TRUE.

Default Value: 100

Min Value: 0

Max Value: 65535

Member: NvmParams.SystemParams.OpStateParams.wKeyfobAvoidanceDurationMs

Keyfob Avoidance Duration Based on I/O

Details:

This parameter, when TRUE, sets the duration of the keyfob avoidance frequency based on the state of the control IO. If this parameter is FALSE, the duration is based on the Operation Time At Avoidance Frequency value.

Default Value: 0

Min Value: 0

Max Value: 1

Member: NvmParams.SystemParams.OpStateParams.byKeyfobAvoidanceDurationBasedOnIo

Keyfob Avoidance Disable Coil

Details:

This parameter, when TRUE, causes the coil to be disabled while keyfob detection is active. When FALSE the frequency hopping keyfob avoidance strategy is used.

Default Value: 0

Min Value: 0

Max Value: 1

Member: NvmParams.SystemParams.OpStateParams.byKeyfobAvoidanceDisableCoil

Power Xfer Control Bitfield A

Details:

Bit0 – This parameter, when TRUE, forces the use of frequency control algorithm (mutually exclusive with rail control)

Bit1 – This parameter, when TRUE, forces the use of rail control algorithm (mutually exclusive with frequency control)

Bit2 – This bit, when set, enables the use of Coil 0

Bit3 – This bit, when set, enables the use of Coil 1

Bit4 – This bit, when set, enables the use of Coil 2

Bit5 – This bit, when set, enables the use of Coil 3

Bit6 – This bit, when set, enables the use of Coil 4

Bit7 – This bit, when set, enables the use of Coil 5

Bit8 – This bit, when set, enables the use of Coil 6

Bit9 – This bit, when set, enables the use of Coil 7

Bit10 – This bit, when set, enables the use of Coil 8

Bit11 – This bit, when set, enables the use of Coil 9

Bit12 – This bit, when set, enabled the use of Device 0

Bit13 – This bit, when set, enabled the use of Device 1

Bit14 – This bit, when set, enabled the use of Device 2

Bit15 – This bit, when set, enabled the use of Device 3

Default Value: 0x101E

Member: NvmParams.SystemParams.OpStateParams.PowerControl

WPC Diagnostics Bitfield A

Details:

Bit0 – Sends PID status to Console when enabled

Bit1 – Sends verbose PID info to Console when enabled

Bit2 – Sends operational status to Console when enabled

Bit3 – Sends verbose operational status to Console when enabled

Bit4 – Sends operational state to Console when enabled

Bit5 – Sends Comm status to Console when enabled

Bit6 – Sends received packet channel to Console when enabled

Bit7 – Sends Auto-baud reference count to Console when enabled

Bit8 – Sends PLD status to Console when enabled

Bit9 – Sends Analog Ping status to Console when enabled

Bit10 – Send supervisory status to Console when enabled

Bit11 – Send RFP Ping sequence status to Console when enabled

Bit14 – This parameter determines whether or not an audible tone is generated when power transfer is stopped.

Bit15 – This parameter determines whether or not an audible tone is generated when power transfer is initiated.

Default Value: 0x810D

Member: NvmParams.SystemParams.OpStateParams.WpcDiagnostics

WPC Protections Bitfield A

Details:

Bit0 – This parameter, when set, forces the primary to cease power transfer if the reported secondary version is not greater

Bit1 – This parameter, when set, forces a cessation of Power Xfer state when the Rectified Power packet is not received

Bit2 – This parameter, when set, disables the use of Analog Ping.

Default Value: 0x02

Member: NvmParams.SystemParams.OpStateParams.WpcProtections

3.2 Operation Parameters

Ping Frequency (Hz)

Details:

This parameter defines the coil frequency to be used during Ping operations (device detection).

NOTE: According to the WPC specification, the range of this value is 105 kHz to 115 kHz for the A13 design.

Default Value: 111000

Min Value: 105000

Max Value: 115000

Member: NvmParams.OpParams[0].OpStateParams.dwPingFrequency

Ping Duty Cycle (%)

Details:

This parameter defines the coil duty cycle to be used during Ping operations (device detection).

Default Value: 50

Min Value: 10

Max Value: 50

Member: `NvmParams.OpParams[0].OpStateParams.wPingDutyCycle`

Ping Pulse Duration (ms)

Details:

This parameter defines the amount of time the Ping frequency should be applied while waiting for device detection.

Default Value: 65

Min Value: 0

Max Value: 65535

Member: `NvmParams.OpParams[0].OpStateParams.wPingPulseDurationTimeMs`

Ping Interval (ms)

Details:

This parameter defines the amount of time between attempts to Ping the secondary for device detection.

Default Value: 400

Min Value: 0

Max Value: 65535

Member: `NvmParams.OpParams[0].OpStateParams.wPingIntervalMs`

Frequency (Hz)

Details:

This parameter defines the coil frequency to be used during Analog Ping operations (presence detection).

Default Value: 111000

Min Value: 105000

Max Value: 115000

Member: `NvmParams.OpParams[0].OpStateParams.dwAnalogPingFrequency`

Min Coil Current (ADC counts)

Details:

This parameter defines the threshold below which an Analog Ping has detected a fault in the resonant tank or coil drive circuit. If the ADC count is not greater than this value, the unit shuts down with a coil fault.

Default Value: 5

Min Value: 0

Max Value: 4095

Member: `NvmParams.OpParams[0].OpStateParams.wAnalogPingMinCoilCurrentThreshold`

Coil Current Threshold (% change)

Details:

This parameter defines the threshold above which an Analog Ping may have detected a changed in device presence.

Default Value: 5

Min Value: 0

Max Value: 100

Member: `NvmParams.OpParams[0].OpStateParams.wAnalogPingCoilCurrentThreshold`

Duty Cycle (%)

Details:

This parameter defines the duty cycle to be used during Analog Ping operations.

Default Value: 50

Min Value: 10

Max Value: 50

Member: `NvmParams.OpParams[0].OpStateParams.byAnalogPingDutyCycle`

Pulse Duration (# cycles)

Details:

This parameter defines the number of cycles that the coil shall be driven during Analog Ping operations.

Default Value: 4

Min Value: 0

Max Value: 255

Member: `NvmParams.OpParams[0].OpStateParams.byAnalogPingPulseDuration`

ADC Sampling Time Delay (# cycles)

Details:

This parameter defines the time at which the ADC samples the coil current (referenced to the start of the pulse).

Default Value: 4

Min Value: 0

Max Value: 255

Member: `NvmParams.OpParams[0].OpStateParams.byAnalogPingAdcSampleTime`

Digital Ping Retry Interval (seconds)

Details:

This parameter defines the interval at which a digital ping is forced.

Default Value: 5

Min Value: 0

Max Value: 255

Member: `NvmParams.OpParams[0].OpStateParams.byDigitalPingRetryIntervalSeconds`

Over Current Threshold (mA)

Details:

This parameter represents the maximum allowable average current on the coil (in mA). If this value is exceeded, the power transfer is aborted and the coil is shut down.

Default Value: 7000

Min Value: 0

Max Value: 65535

Member: NvmParams.OpParams[0].OpStateParams.wOverCurrentThreshold

Safety Input Threshold (ADC counts)

Details:

This parameter represents the maximum allowable safety input voltage. If the input voltage exceeds this threshold, the operational state machine shuts down the associated coil.

Default Value: 2048

Min Value: 0

Max Value: 4095

Member: NvmParams.OpParams[0].OpStateParams.wSafetyInputThreshold

Input Power Threshold (mW)

Details:

This parameter represents the maximum allowable input power to the channel (in mW). If the input power exceeds this threshold, the operational state machine shuts down the associated coil.

Default Value: 12000

Min Value: 0

Max Value: 20000

Member: NvmParams.OpParams[0].OpStateParams.dwInputPowerThreshold

Minimum Frequency (Hz)

Details:

This parameter defines the absolute minimum allowable frequency used during charging. If the power transfer algorithm attempts to set the “Active Frequency” below this value, the coil is turned OFF. NOTE: This value varies from the WPC v1.0 specification of 110KHz due to the frequency limit of this design.

Default Value: 111000

Min Value: 0

Max Value: 200000

Member: NvmParams.OpParams[0].OpStateParams.dwMinFreq

Maximum Frequency (Hz)

Details:

This parameter defines the maximum allowable frequency used during power transfer. If the power transfer algorithm attempts to set the “Active Frequency” above this value, the coil is turned OFF. NOTE: This value varies from the WPC v1.0 specification of 205KHz due to the frequency limit of this design.

Default Value: 111000

Min Value: 0

Max Value: 200000

Member: NvmParams.OpParams[0].OpStateParams.dwMaxFreq

Keyfob Avoidance Frequency

Details:

This parameter defines the operating frequency of the coil when Keyfob Avoidance is active.

Default Value: 160000

Min Value: 0

Max Value: 300000

Member: NvmParams.OpParams[0].OpStateParams.dwKeyfobAvoidanceFreq

Integral Update Interval

Details:

This parameter defines the time constant for the integrator update rate in ms.

Default Value: 5

Min Value: 0

Max Value: 65535

Member: NvmParams.OpParams[0].OpStateParams.wIntegralUpdateInterval

Derivative Update Interval

Details:

This parameter defines the time constant for the derivative update rate in ms.

Default Value: 5

Min Value: 0

Max Value: 65535

Member: NvmParams.OpParams[0].OpStateParams.wDerivativeUpdateInterval

Integral Upper Limit

Details:

This parameter defines the maximum allowable value for the Integral Term of the PID control signal, as described below.

Default Value: 3000

Min Value: -32768

Max Value: 32767

Member: NvmParams.OpParams[0].OpStateParams.iIntegralUpperLimit

Integral Lower Limit

Details:

This parameter defines the minimum allowable value for the Integral Term of the PID control signal, as described below.

Default Value: -3000

Min Value: -32768

Max Value: 32767

Member: NvmParams.OpParams[0].OpStateParams.iIntegralLowerLimit

PID Output Upper Limit

Details:

This parameter defines the maximum allowable value for the PID output, as described below.

Default Value: 20000

Min Value: -32768

Max Value: 32767

Member: `NvmParams.OpParams[0].OpStateParams.iPidUpperLimit`

PID Output Lower Limit

Details:

This parameter defines the minimum allowable value for the PID output, as described below.

Default Value: -20000

Min Value: -32768

Max Value: 32767

Member: `NvmParams.OpParams[0].OpStateParams.iPidLowerLimit`

PID Scale Factor

Details:

This parameter defines how the PID output is scaled when calculating the new Frequency setpoint, as described below.

Default Value: 200

Min Value: 0

Max Value: 65535

Member: `NvmParams.OpParams[0].OpStateParams.wPidScaleFactor`

Proportional Gain (Kp)

Details:

NOTE: Maximum value = 127

Default Value: 10

Min Value: 0

Max Value: 255

Member: `NvmParams.OpParams[0].OpStateParams.byKp`

Integral Gain (Ki)

Details:

NOTE: Maximum value = 127

Default Value: 1

Min Value: 0

Max Value: 255

Member: `NvmParams.OpParams[0].OpStateParams.byKi`

Derivative Gain (Kd)

Details:

NOTE: Maximum value = 127

Default Value: 1

Min Value: 0

Max Value: 255

Member: NvmParams.OpParams[0].OpStateParams.byKd

PID Delay Time (ms)

Details:

This parameter defines the delay between receipt of a voltage error message and activation of the PID. This period of time is necessary to allow the primary current to return to steady state before attempting an adjustment. Per the WPC specification, this value should be set to '5'.

Default Value: 5

Min Value: 0

Max Value: 255

Member: NvmParams.OpParams[0].OpStateParams.byDelayTimeMs

PID Active Time (ms)

Details:

This parameter defines how long the PID is active to attempt an adjustment to a new setpoint. Per the WPC specification, this value should be set to '20'.

Default Value: 20

Min Value: 0

Max Value: 255

Member: NvmParams.OpParams[0].OpStateParams.byActiveTimeMs

PID Settle Time (ms)

Details:

This parameter defines how long the PID loop continues to sample the primary current after PID adjustment is complete. This allows the primary current and the digital filter to settle. The final settled value becomes the basis for the next adjustment. Per the WPC specification, this should be '3'.

Default Value: 3

Min Value: 0

Max Value: 255

Member: NvmParams.OpParams[0].OpStateParams.bySettleTimeMs

Num PID Adjustments Per Active Window

Details:

This parameter defines the number of PID iterations that the firmware runs within the Active Time window. Adjustments are only attempted upon receipt of a non-zero error message.

Default Value: 5

Min Value: 0

Max Value: 255

Member: NvmParams.OpParams[0].OpStateParams.byNumPidAdjustmentsPerActiveWindow

Maximum Duty Cycle (%)

Details:

Maximum Duty Cycle (%)

Default Value: 50

Min Value: 0

Max Value: 50

Member: NvmParams.OpParams[0].OpStateParams.byMaxDutyCycle

Minimum Duty Cycle (%)

Details:

“Minimum Duty Cycle (%)NOTE: This value varies from the typical value of 10%.”

Default Value: 50

Min Value: 0

Max Value: 50

Member: NvmParams.OpParams[0].OpStateParams.byMinDutyCycle

Duty Cycle Step (hundredths of %)

Details:

Duty Cycle Step (in hundredths of a %, equivalent to breakpoint value for frequency control)

Default Value: 10

Min Value: 1

Max Value: 255

Member: NvmParams.OpParams[0].OpStateParams.byDCStep

Duty Cycle PID Scaling Factor

Details:

Defines how the PID output is scaled when calculating a new Duty Cycle setpoint.

Default Value: 10

Min Value: 1

Max Value: 255

Member: NvmParams.OpParams[0].OpStateParams.byDCPidScaleFactor

Duty Cycle Proportional Gain (Kp)

Details:

NOTE: Maximum value = 127

Default Value: 10

Min Value: 0

Max Value: 255

Member: NvmParams.OpParams[0].OpStateParams.byDCKp

Duty Cycle Integral Gain (Ki)

Details:

NOTE: Maximum value = 127

Default Value: 1

Min Value: 0

Max Value: 255

Member: NvmParams.OpParams[0].OpStateParams.byDCKi

Duty Cycle Derivative Gain (Kd)

Details:

NOTE: Maximum value = 127

Default Value: 0

Min Value: 0

Max Value: 255

Member: NvmParams.OpParams[0].OpStateParams.byDCKd

Minimum Rail Voltage (mV)

Details:

This parameter defines the minimum operating Rail Voltage for the output drive – specified in mV. A value of 10000 corresponds to 10.0V.

Default Value: 1000

Min Value: 0

Max Value: 20000

Member: NvmParams.OpParams[0].OpStateParams.wMinRailVoltageMv

Maximum Rail Voltage (mV)

Details:

This parameter defines the maximum operating Rail Voltage for the output drive – specified in mV. A value of 10000 corresponds to 10.0V.

Default Value: 11500

Min Value: 0

Max Value: 20000

Member: NvmParams.OpParams[0].OpStateParams.wMaxRailVoltageMv

Coil 0 Default Rail Voltage (mV)

Details:

This parameter defines the operating Rail Voltage for the Coil0 output drive – specified in mV. When in Rail Control, this value corresponds to the rail voltage used at Ping. A value of 1000 corresponds to 1.0V. Value 3000 to 4000 is for a bottom Primary Coil, and Value 2500 to 3500 is for a top Primary Coil.

Default Value: 3500

Min Value: 3000

Max Value: 4000

Member: NvmParams.OpParams[0].OpStateParams.wDefaultRailVoltageMv[0]

Coil 1 Default Rail Voltage (mV)

Details:

This parameter defines the operating Rail Voltage for the Coil1 output drive – specified in mV. When in Rail Control, this value corresponds to the rail voltage used at Ping. A value of 1000 corresponds to 1.0V. Value 3000 to 4000 is for a bottom Primary Coil, and Value 2500 to 3500 is for a top Primary Coil.

Default Value: 3500

Min Value: 2500

Max Value: 3500

Member: `NvmParams.OpParams[0].OpStateParams.wDefaultRailVoltageMv[1]`

Coil 2 Default Rail Voltage (mV)

Details:

This parameter defines the operating Rail Voltage for the Coil2 output drive – specified in mV. When in Rail Control, this value corresponds to the rail voltage used at Ping. A value of 1000 corresponds to 1.0V. Value 3000 to 4000 is for a bottom Primary Coil, and Value 2500 to 3500 is for a top Primary Coil.

Default Value: 3500

Min Value: 3000

Max Value: 4000

Member: `NvmParams.OpParams[0].OpStateParams.wDefaultRailVoltageMv[2]`

Rail Voltage Step (mV)

Details:

Rail Voltage Step (in mV, equivalent to breakpoint value for frequency control)

Default Value: 10

Min Value: 0

Max Value: 1000

Member: `NvmParams.OpParams[0].OpStateParams.wRailStepMv`

Rail Voltage PID Scaling Factor

Details:

Defines how the PID output is scaled when calculating a new Rail Voltage setpoint.

Default Value: 100

Min Value: 0

Max Value: 255

Member: `NvmParams.OpParams[0].OpStateParams.wRailPidScaleFactor`

Rail Voltage Proportional Gain (Kp)

Details:

NOTE: Maximum value = 127

Default Value: 2

Min Value: 0

Max Value: 255

Member: `NvmParams.OpParams[0].OpStateParams.byRailKp`

Rail Voltage Integral Gain (Ki)

Details:

NOTE: Maximum value = 127

Default Value: 1

Min Value: 0

Max Value: 255

Member: NvmParams.OpParams[0].OpStateParams.byRailKi

Rail Voltage Derivative Gain (Kd)

Details:

NOTE: Maximum value = 127

Default Value: 0

Min Value: 0

Max Value: 255

Member: NvmParams.OpParams[0].OpStateParams.byRailKd

Minimum Rail Voltage (mV)

Details:

This parameter defines the minimum operating Rail Voltage for the output drive – specified in mV. A value of 10000 corresponds to 10.0V.

Default Value: 4000

Min Value: 0

Max Value: 20000

Member: NvmParams.OpParams[0].OpStateParams.wMinPowerMatRailVoltageMv

Maximum Rail Voltage (mV)

Details:

This parameter defines the maximum operating Rail Voltage for the output drive – specified in mV. A value of 10000 corresponds to 10.0V.

Default Value: 12000

Min Value: 0

Max Value: 20000

Member: NvmParams.OpParams[0].OpStateParams.wMaxPowerMatRailVoltageMv

Default High Error (%)

Details:

This parameter defines the default Error percentage used when the Powermat device reports its regulation point is “too high”.

Default Value: -5

Min Value: -100

Max Value: 100

Member: NvmParams.OpParams[0].OpStateParams.iDefaultHighError

Default Low Error (%)

Details:

This parameter defines the default Error percentage used when the Powermat device reports its regulation point is “too low”.

Default Value: 5

Min Value: -100

Max Value: 100

Member: `NvmParams.OpParams[0].OpStateParams.iDefaultLowError`

Powermat COMM Timeout (ms)

Details:

This parameter defines how long the state machine maintains Power Xfer state without detected communications from the Powermat device.

Default Value: 200

Min Value: 0

Max Value: 5000

Member: `NvmParams.OpParams[0].OpStateParams.wPowerMatCommTimeoutMs`

Minimum Edges Required to Qualify State

Details:

This parameter defines the number of successive pulse timing samples that must match to declare a new Powermat operating state.

Default Value: 5

Min Value: 0

Max Value: 20

Member: `NvmParams.OpParams[0].OpStateParams.wMinEdgesToQualifyPowerMatState`

Delta Frequency 1 (Hz)

Details:

This is the frequency step to take when the current frequency is less than or equal to the specified Frequency Breakpoint 1.

Default Value: 100

Min Value: 0

Max Value: 65535

Member: `NvmParams.OpParams[0].OpStateParams.FreqBreakPointTable[0].dwDeltaFreq`

Frequency Breakpoint 1 (Hz)

Details:

This is the upper frequency limit for this entry in the look-up table.

Default Value: 130000

Min Value: 0

Max Value: 4294967295

Member: `NvmParams.OpParams[0].OpStateParams.FreqBreakPointTable[0].dwFreqBreakPoint`

Delta Frequency 2 (Hz)

Details:

This is the frequency step to take when the current frequency is less than the specified Frequency Breakpoint 2, but greater than Frequency Breakpoint 1.

Default Value: 150

Min Value: 0

Max Value: 65535

Member: NvmParams.OpParams[0].OpStateParams.FreqBreakPointTable[1].dwDeltaFreq

Frequency Breakpoint 2 (Hz)

Details:

This is the upper frequency limit for this entry in the look-up table.

Default Value: 140000

Min Value: 0

Max Value: 4294967295

Member: NvmParams.OpParams[0].OpStateParams.FreqBreakPointTable[1].dwFreqBreakPoint

Delta Frequency 3 (Hz)

Details:

This is the frequency step to take when the current frequency is less than the specified Frequency Breakpoint 3, but greater than Frequency Breakpoint 2.

Default Value: 200

Min Value: 0

Max Value: 65535

Member: NvmParams.OpParams[0].OpStateParams.FreqBreakPointTable[2].dwDeltaFreq

Frequency Breakpoint 3 (Hz)

Details:

This is the upper frequency limit for this entry in the look-up table.

Default Value: 160000

Min Value: 0

Max Value: 4294967295

Member: NvmParams.OpParams[0].OpStateParams.FreqBreakPointTable[2].dwFreqBreakPoint

Delta Frequency 4 (Hz)

Details:

This is the frequency step to take when the current frequency is less than the specified Frequency Breakpoint 4, but greater than Frequency Breakpoint 3.

Default Value: 300

Min Value: 0

Max Value: 65535

Member: NvmParams.OpParams[0].OpStateParams.FreqBreakPointTable[3].dwDeltaFreq

Frequency Breakpoint 4 (Hz)

Details:

This is the upper frequency limit for this entry in the look-up table.

Default Value: 180000

Min Value: 0

Max Value: 4294967295

Member: NvmParams.OpParams[0].OpStateParams.FreqBreakPointTable[3].dwFreqBreakPoint

Delta Frequency 5 (Hz)

Details:

This parameter defines the default frequency step during power transfer (when the “Active Frequency” is greater than the “Frequency Breakpoint” defined by Charging Frequency Breakpoint 4).

Default Value: 500

Min Value: 0

Max Value: 65535

Member: NvmParams.OpParams[0].OpStateParams.dwDeltaFreq5

Power Loss Indication To Power Cessation (ms)

Details:

This parameter defines how long the MOD indication is permitted to be active before removal of power.

Default Value: 1000

Min Value: 0

Max Value: 4294967295

Member: NvmParams.OpParams[0].PowerLossParams.dwPowerLossIndicationToPwrCessationMs

Power Loss Fault Retry Time (ms)

Details:

This parameter defines how long the Transmitter waits before attempting power transfer following an MOD Fault.

Default Value: 300000

Min Value: 0

Max Value: 4294967295

Member: NvmParams.OpParams[0].PowerLossParams.dwPowerLossFaultRetryTimeMs

Power Loss Base Threshold (mW)

Details:

This parameter defines the base threshold for MOD in mW, representing the threshold used by the firmware if the MOD selection is set to bin ‘0’.

Default Value: 400

Min Value: 0

Max Value: 65535

Member: NvmParams.OpParams[0].PowerLossParams.wPowerLossBaseThreshold

Power Loss Incremental Threshold (mW)

Details:

“This parameter defines the incremental threshold used to calculate the overall MOD threshold based on the MOD bin selection. The formula is as follows: MOD Threshold = MOD Base Threshold + (MOD Incremental Threshold * Bin#)”

Default Value: 100

Min Value: 0

Max Value: 65535

Member: NvmParams.OpParams[0].PowerLossParams.wPowerLossIncrementalThreshold

Number of Trips to Indication

Details:

This parameter defines how many consecutive threshold breaches are required to trigger an MOD indication.

Default Value: 3

Min Value: 0

Max Value: 255

Member: NvmParams.OpParams[0].PowerLossParams.byNumFodTripsToIndication

Default Window Offset (ms)

Details:

This parameter defines the amount of time (in ms) between when the Secondary measures its operating parameters and when the START bit of the Power Usage packet occurs. This parameter is used by the primary firmware to synchronize its ADC samples with those of the secondary for MOD calculations when a Receiver is not compliant with v1.1 or greater (does not support FOD).

Default Value: 18

Min Value: 0

Max Value: 15

Member: NvmParams.OpParams[0].PowerLossParams.byDefaultWindowOffset

Dump PLD Results for Legacy Devices

Details:

This parameter, when set, forces the reporting of all PLD calculation results when a legacy (v1.0 compliant) device is detected. (Normally, this information is 35oiled35sed since these devices do not support Received Power packets.)

Default Value: 0

Min Value: 0

Max Value: 1

Member: NvmParams.OpParams[0].PowerLossParams.byDumpPldResultsForLegacyDevices

3.3 Calibration Parameters

Minimum Rail Voltage (mV)

Details:

Indicates the minimum rail voltage the hardware is capable of producing

Default Value: 1883

Min Value: 0

Max Value: 65535

Member: NvmParams.CalParams.AnalogParams[0].wMinRailVoltageMv

Maximum Rail Voltage (mV)

Details:

Indicates the maximum rail voltage the hardware is capable of producing

Default Value: 10141

Min Value: 0

Max Value: 65535

Member: NvmParams.CalParams.AnalogParams[0].wMaxRailVoltageMv

Rail Voltage Cal Slope

Details:

This field defines the rail voltage normalized calibration slope.

Default Value: -101

Min Value: -2147483647

Max Value: 2147483647

Member: NvmParams.CalParams.AnalogParams[0].sdwRailVoltageSlope

Rail Voltage Cal Offset

Details:

This field defines the rail voltage normalized calibration offset.

Default Value: 449618

Min Value: -2147483647

Max Value: 2147483647

Member: NvmParams.CalParams.AnalogParams[0].sdwRailVoltageOffset

Input Current Cal Slope

Details:

This field defines the input current normalized calibration slope which corrects for the portion of the input current which is dependent on the rail voltage.

Default Value: -242

Min Value: -2147483647

Max Value: 2147483647

Member: NvmParams.CalParams.AnalogParams[0].sdwInputCurrentSlope

Input Current Cal Offset

Details:

This field defines the input current normalized calibration offset which corrects for the portion of the input current which is dependent on the rail voltage.

Default Value: 6698652

Min Value: -2147483647

Max Value: 2147483647

Member: NvmParams.CalParams.AnalogParams[0].sdwInputCurrentOffset

Rail Voltage Cal Normalization

Details:

This parameter defines the normalization factor used in the rail voltage normalized calibration

Default Value: 5

Min Value: 0

Max Value: 65535

Member: NvmParams.CalParams.AnalogParams[0].wRailVoltageNorm

Input Current Cal Normalization

Details:

This parameter defines the normalization factor used in the input current normalized calibration

Default Value: 19

Min Value: 0

Max Value: 65535

Member: NvmParams.CalParams.AnalogParams[0].wInputCurrentNorm

Input Voltage Calibration Constant (100% = 32768)

Details:

Indicates the calibration error for the ADC reading of Input Voltage. A value of /77%/ (translated to a parameter value of 25231) indicates that the actual value of the Input Voltage is 77% of the reported ADC value for the system.

Default Value: 33093

Min Value: 0

Max Value: 65535

Member: NvmParams.CalParams.AnalogParams[0].wInputVoltageCalibration

Input Current Calibration Constant (100% = 32768)

Details:

Indicates the calibration error for the ADC reading of Input Current. A value of /77%/ (translated to a parameter value of 25231) indicates that the actual value of the Input Current is 77% of the reported ADC value for the system.

Default Value: 32452

Min Value: 0

Max Value: 65535

Member: NvmParams.CalParams.AnalogParams[0].wInputCurrentCalibration

Coil Current Calibration Constant (100% = 32768)

Details:

Indicates the calibration error for the ADC reading of Coil Current. A value of /77%/ (translated to a parameter value of 25231) indicates that the actual value of the Coil Current is 77% of the reported ADC value for the system.

Default Value: 32768

Min Value: 0

Max Value: 65535

Member: NvmParams.CalParams.AnalogParams[0].wCoilCurrentCalibration

Coil Current Diode Drop (mV)

Details:

“This parameter defines the nominal voltage drop of the diode used in the Coil Current peak detect circuitry. NOTE: A value of 0.700 is represented as 700.

Default Value: 0

Min Value: 0

Max Value: 65535

Member: `NvmParams.CalParams.AnalogParams[0].wCoilCurrentDiodeDrop`

C5 – Quadratic Coefficient (mW/mA² x 2^{N5})

Details:

This parameter defines the quadratic coefficient of the equation used to calculate transmission (Tx) losses represented in units of mW/mA² multiplied by the value of 2^{N5}, where N5 is the exponent defined by the next parameter.

Default Value: 0x6B79

Min Value: -32768

Max Value: 32767

Member: `NvmParams.CalParams.PowerLossParams[0].FodCharacterizationParams[0].swQuadCoefficient`

C5 Exponent (N5)

Details:

This parameter is the value of the exponent used to scale the C5 coefficient to obtain an integer value in units of mW/mA².

Default Value: 0x1A

Min Value: 0

Max Value: 65535

Member: `NvmParams.CalParams.PowerLossParams[0].FodCharacterizationParams[0].wQuadExponent`

C6 – Linear Coefficient (mW/mA x 2^{N6})

Details:

This parameter defines the linear coefficient of the equation used to calculate Tx losses represented in units of mW/mA multiplied by the value of 2^{N6}, where N6 is the exponent defined by the next parameter.

Default Value: 0x5291

Min Value: -32768

Max Value: 32767

Member:

`NvmParams.CalParams.PowerLossParams[0].FodCharacterizationParams[0].swLinearCoefficient`

C6 Exponent (N6)

Details:

This parameter is the value of the exponent used to scale the C6 coefficient to obtain an integer value in units of mW/mA.

Default Value: 0x11

Min Value: 0

Max Value: 65535

Member: `NvmParams.CalParams.PowerLossParams[0].FodCharacterizationParams[0].wLinearExponent`

C7 – Constant Term (mW)

Details:

This parameter represents the constant term of the equation used to calculate Tx losses (represented in mW). This value equates to the static losses of the FET drive circuitry.

Default Value: 0x16

Min Value: -32768

Max Value: 32767

Member:

`NvmParams.CalParams.PowerLossParams[0].FodCharacterizationParams[0].swConstantCoefficient`

Power Loss Calibration Offset (mW)

Details:

This parameter represents the offset to be used with the calculation of system Power Loss to prevent negative results due to resolution on reported Rx power received, curve-fit and other calibration errors.

Default Value: 0

Min Value: -30000

Max Value: 30000

Member:

`NvmParams.CalParams.PowerLossParams[0].FodCharacterizationParams[0].swPowerLossCalibrationOffset`

C5 – Quadratic Coefficient (mW/mA² x 2^{N5})

Details:

This parameter defines the quadratic coefficient of the equation used to calculate Tx losses represented in units of mW/mA² multiplied by the value of 2^{N5}, where N5 is the exponent defined by the next parameter.

Default Value: 0x674C

Min Value: -32768

Max Value: 32767

Member: `NvmParams.CalParams.PowerLossParams[0].FodCharacterizationParams[1].swQuadCoefficient`

C5 Exponent (N5)

Details:

This parameter is the value of the exponent used to scale the C5 coefficient to obtain an integer value in units of mW/mA².

Default Value: 0x1A

Min Value: 0

Max Value: 65535

Member: `NvmParams.CalParams.PowerLossParams[0].FodCharacterizationParams[1].wQuadExponent`

C6 – Linear Coefficient (mW/mA x 2^{N6})

Details:

This parameter defines the linear coefficient of the equation used to calculate Tx losses represented in units of mW/mA multiplied by the value of 2^{N6}, where N6 is the exponent defined by the next parameter.

Default Value: 0x50C1

Min Value: -32768

Max Value: 32767

Member:

`NvmParams.CalParams.PowerLossParams[0].FodCharacterizationParams[1].swLinearCoefficient`

C6 Exponent (N6)

Details:

This parameter is the value of the exponent used to scale the C6 coefficient to obtain an integer value in units of mW/mA.

Default Value: 0x12

Min Value: 0

Max Value: 65535

Member: `NvmParams.CalParams.PowerLossParams[0].FodCharacterizationParams[1].wLinearExponent`

C7 – Constant Term (mW)

Details:

This parameter represents the constant term of the equation used to calculate Tx losses (represented in mW). This value equates to the static losses of the FET drive circuitry.

Default Value: 0x54

Min Value: -32768

Max Value: 32767

Member:

`NvmParams.CalParams.PowerLossParams[0].FodCharacterizationParams[1].swConstantCoefficient`

Power Loss Calibration Offset (mW)

Details:

This parameter represents the offset to be used with the calculation of system Power Loss to prevent negative results due to resolution on reported Rx power received, curve-fit and other calibration errors.

Default Value: 0

Min Value: -30000

Max Value: 30000

Member:

`NvmParams.CalParams.PowerLossParams[0].FodCharacterizationParams[1].swPowerLossCalibrationOffset`

C5 – Quadratic Coefficient (mW/mA² x 2^{N5})

Details:

This parameter defines the quadratic coefficient of the equation used to calculate Tx losses represented in units of mW/mA² multiplied by the value of 2^{N5}, where N5 is the exponent defined by the next parameter.

Default Value: 0x6C44

Min Value: -32768

Max Value: 32767

Member: `NvmParams.CalParams.PowerLossParams[0].FodCharacterizationParams[2].swQuadCoefficient`

C5 Exponent (N5)

Details:

This parameter is the value of the exponent used to scale the C5 coefficient to obtain an integer value in units of mW/mA².

Default Value: 0x1A

Min Value: 0

Max Value: 65535

Member: NvmParams.CalParams.PowerLossParams[0].FodCharacterizationParams[2].wQuadExponent

C6 – Linear Coefficient (mW/mA x 2^{N6})

Details:

This parameter defines the linear coefficient of the equation used to calculate Tx losses represented in units of mW/mA multiplied by the value of 2^{N6}, where N6 is the exponent defined by the next parameter.

Default Value: 0x79B3

Min Value: -32768

Max Value: 32767

Member:

NvmParams.CalParams.PowerLossParams[0].FodCharacterizationParams[2].swLinearCoefficient

C6 Exponent (N6)

Details:

This parameter is the value of the exponent used to scale the C6 coefficient to obtain an integer value in units of mW/mA.

Default Value: 0x12

Min Value: 0

Max Value: 65535

Member: NvmParams.CalParams.PowerLossParams[0].FodCharacterizationParams[2].wLinearExponent

C7 – Constant Term (mW)

Details:

This parameter represents the constant term of the equation used to calculate Tx losses (represented in mW). This value equates to the static losses of the FET drive circuitry.

Default Value: 0x34

Min Value: -32768

Max Value: 32767

Member:

NvmParams.CalParams.PowerLossParams[0].FodCharacterizationParams[2].swConstantCoefficient

Power Loss Calibration Offset (mW)

Details:

This parameter represents the offset to be used with the calculation of system Power Loss to prevent negative results due to resolution on reported Rx power received, curve-fit and other calibration errors.

Default Value: 0

Min Value: -30000

Max Value: 30000

Member:

`NvmParams.CalParams.PowerLossParams[0].FodCharacterizationParams[2].swPowerLossCalibrationOffset`

CA1 – Quadratic Coefficient for region A (mW/mW² x 2^{NA1})

Details:

This parameter defines the quadratic coefficient of the equation used to calculate the normalization for system power losses represented in units of mW/mW² multiplied by the value of 2^{NA1}, where NA1 is the exponent defined by the next parameter.

Default Value: 0x8586

Min Value: -32768

Max Value: 32767

Member:

`NvmParams.CalParams.PowerLossParams[0].FodNormalizationParams[0].QuadraticParams[0].swQuadraticCoefficient`

CA1 Exponent (NA1)

Details:

This parameter is the value of the exponent used to scale the CA1 coefficient to obtain an integer value in units of mW/mW².

Default Value: 0x1F

Min Value: 0

Max Value: 65535

Member:

`NvmParams.CalParams.PowerLossParams[0].FodNormalizationParams[0].QuadraticParams[0].wQuadraticExponent`

CA2 – Linear Coefficient for region A(mW/mW x 2^{NA2})

Details:

This parameter defines the linear coefficient of the equation used to calculate the normalization for system power losses represented in units of mW/mW multiplied by the value of 2^{NA2}, where NA2 is the exponent defined by the next parameter.

Default Value: 0x7E2C

Min Value: -32768

Max Value: 32767

Member:

`NvmParams.CalParams.PowerLossParams[0].FodNormalizationParams[0].QuadraticParams[0].swLinearCoefficient`

CA2 Exponent (NA2)

Details:

This parameter is the value of the exponent used to scale the CA2 coefficient to obtain an integer value in units of mW/mW.

Default Value: 0x14

Min Value: 0

Max Value: 65535

Member:

`NvmParams.CalParams.PowerLossParams[0].FodNormalizationParams[0].QuadraticParams[0].wLinearExponent`

CA3 – Constant Term for region A (mW)

Details:

“This parameter represents the constant term of the equation used to calculate the normalization for system power losses (represented in mW).

Default Value: 0xFFC6

Min Value: -32768

Max Value: 32767

Member:

`NvmParams.CalParams.PowerLossParams[0].FodNormalizationParams[0].QuadraticParams[0].swConstantCoefficient`

CB1 – Quadratic Coefficient for region B(mW/mW² x 2^{NB1})

Details:

This parameter defines the quadratic coefficient of the equation used to calculate the normalization for system power losses represented in units of mW/mW² multiplied by the value of 2^{NB1}, where NB1 is the exponent defined by the next parameter.

Default Value: 0x8586

Min Value: -32768

Max Value: 32767

Member:

`NvmParams.CalParams.PowerLossParams[0].FodNormalizationParams[0].QuadraticParams[1].swQuadCoefficient`

CB1 Exponent (NB1)

Details:

This parameter is the value of the exponent used to scale the CB1 coefficient to obtain an integer value in units of mW/mW².

Default Value: 0x1F

Min Value: 0

Max Value: 65535

Member:

`NvmParams.CalParams.PowerLossParams[0].FodNormalizationParams[0].QuadraticParams[1].wQuadExponent`

CB2 – Linear Coefficient for region B(mW/mW x 2^{NB2})

Details:

This parameter defines the linear coefficient of the equation used to calculate the normalization for system power losses represented in units of mW/mW multiplied by the value of 2^{NB2}, where NB2 is the exponent defined by the next parameter.

Default Value: 0x7E2C

Min Value: -32768

Max Value: 32767

Member:

`NvmParams.CalParams.PowerLossParams[0].FodNormalizationParams[0].QuadraticParams[1].swLinearCoefficient`

CB2 Exponent (NB2)

Details:

This parameter is the value of the exponent used to scale the CB2 coefficient to obtain an integer value in units of mW/mW.

Default Value: 0x14

Min Value: 0

Max Value: 65535

Member:

`NvmParams.CalParams.PowerLossParams[0].FodNormalizationParams[0].QuadraticParams[1].wLinearExponent`

CB3 – Constant Term for region B (mW)

Details:

This parameter represents the constant term of the equation used to calculate the normalization for system power losses (represented in mW).

Default Value: 0xFFC6

Min Value: -32768

Max Value: 32767

Member:

`NvmParams.CalParams.PowerLossParams[0].FodNormalizationParams[0].QuadraticParams[1].swConstantCoefficient`

CC1 – Quadratic Coefficient for region C (mW/mW² x 2^{NC1})

Details:

This parameter defines the quadratic coefficient of the equation used to calculate the normalization for system power losses represented in units of mW/mW² multiplied by the value of 2^{NC1}, where NC1 is the exponent defined by the next parameter.

Default Value: 0x8586

Min Value: -32768

Max Value: 32767

Member:

`NvmParams.CalParams.PowerLossParams[0].FodNormalizationParams[0].QuadraticParams[2].swQuadCoefficient`

CC1 Exponent (NC1)

Details:

This parameter is the value of the exponent used to scale the CC1 coefficient to obtain an integer value in units of mW/mW².

Default Value: 0x1F

Min Value: 0

Max Value: 65535

Member:

`NvmParams.CalParams.PowerLossParams[0].FodNormalizationParams[0].QuadraticParams[2].wQuadExponent`

CC2 – Linear Coefficient for region C (mW/mW x 2^{NC2})**Details:**

This parameter defines the linear coefficient of the equation used to calculate the normalization for system power losses represented in units of mW/mW multiplied by the value of 2^{NC2}, where NC2 is the exponent defined by the next parameter.

Default Value: 0x7E2C

Min Value: -32768

Max Value: 32767

Member:

`NvmParams.CalParams.PowerLossParams[0].FodNormalizationParams[0].QuadraticParams[2].swLinearCoefficient`

CC2 Exponent (NC2)**Details:**

This parameter is the value of the exponent used to scale the CC2 coefficient to obtain an integer value in units of mW/mW.

Default Value: 0x14

Min Value: 0

Max Value: 65535

Member:

`NvmParams.CalParams.PowerLossParams[0].FodNormalizationParams[0].QuadraticParams[2].wLinearExponent`

CC3 – Constant Term for region C (mW)**Details:**

This parameter represents the constant term of the equation used to calculate the normalization for system power losses (represented in mW).

Default Value: 0xFFC6

Min Value: -32768

Max Value: 32767

Member:

`NvmParams.CalParams.PowerLossParams[0].FodNormalizationParams[0].QuadraticParams[2].swConstantCoefficient`

Normalization Region A Breakpoint (mW)**Details:**

This parameter defines the maximum Received Power in mW for Normalization Region A

Default Value: 1774

Min Value: 0

Max Value: 200000

Member:

`NvmParams.CalParams.PowerLossParams[0].FodNormalizationParams[0].dwNormalizationBreakpoint[0]`

Normalization Region B Breakpoint (mW)

Details:

This parameter defines the maximum Received Power in mW for Normalization Region B

Default Value: 4168

Min Value: 0

Max Value: 200000

Member:

`NvmParams.CalParams.PowerLossParams[0].FodNormalizationParams[0].dwNormalizationBreakpoint[1]`

CA1 – Quadratic Coefficient for region A(mW/mW² x 2^{NA1})

Details:

This parameter defines the quadratic coefficient of the equation used to calculate the normalization for system power losses represented in units of mW/mW² multiplied by the value of 2^{NA1}, where NA1 is the exponent defined by the next parameter.

Default Value: 0x9354

Min Value: -32768

Max Value: 32767

Member:

`NvmParams.CalParams.PowerLossParams[0].FodNormalizationParams[1].QuadraticParams[0].swQuadCoefficient`

CA1 Exponent (NA1)

Details:

This parameter is the value of the exponent used to scale the CA1 coefficient to obtain an integer value in units of mW/mW².

Default Value: 0x1F

Min Value: 0

Max Value: 65535

Member:

`NvmParams.CalParams.PowerLossParams[0].FodNormalizationParams[1].QuadraticParams[0].wQuadExponent`

CA2 – Linear Coefficient for region A(mW/mW x 2^{NA2})

Details:

This parameter defines the linear coefficient of the equation used to calculate the normalization for system power losses represented in units of mW/mW multiplied by the value of 2^{NA2}, where NA2 is the exponent defined by the next parameter.

Default Value: 0x72EB

Min Value: -32768

Max Value: 32767

Member:

`NvmParams.CalParams.PowerLossParams[0].FodNormalizationParams[1].QuadraticParams[0].swLinearCoefficient`

CA2 Exponent (NA2)

Details:

This parameter is the value of the exponent used to scale the CA2 coefficient to obtain an integer value in units of mW/mW.

Default Value: 0x15

Min Value: 0

Max Value: 65535

Member:

`NvmParams.CalParams.PowerLossParams[0].FodNormalizationParams[1].QuadraticParams[0].wLinearExponent`

CA3 – Constant Term for region A (mW)

Details:

This parameter represents the constant term of the equation used to calculate the normalization for system power losses (represented in mW).

Default Value: 0xFFCF

Min Value: -32768

Max Value: 32767

Member:

`NvmParams.CalParams.PowerLossParams[0].FodNormalizationParams[1].QuadraticParams[0].swConstantCoefficient`

CB1 – Quadratic Coefficient for region B (mW/mW² x 2^{NB1})

Details:

This parameter defines the quadratic coefficient of the equation used to calculate the normalization for system power losses represented in units of mW/mW² multiplied by the value of 2^{NB1}, where NB1 is the exponent defined by the next parameter.

Default Value: 0x9354

Min Value: -32768

Max Value: 32767

Member:

`NvmParams.CalParams.PowerLossParams[0].FodNormalizationParams[1].QuadraticParams[1].swQuadCoefficient`

CB1 Exponent (NB1)

Details:

This parameter is the value of the exponent used to scale the CB1 coefficient to obtain an integer value in units of mW/mW².

Default Value: 0x1F

Min Value: 0

Max Value: 65535

Member:

`NvmParams.CalParams.PowerLossParams[0].FodNormalizationParams[1].QuadraticParams[1].wQuadExponent`

CB2 – Linear Coefficient for region B (mW/mW x 2^{NB2})

Details:

This parameter defines the linear coefficient of the equation used to calculate the normalization for system power losses represented in units of mW/mW multiplied by the value of 2^{NB2} , where NB2 is the exponent defined by the next parameter.

Default Value: 0x72EB

Min Value: -32768

Max Value: 32767

Member:

`NvmParams.CalParams.PowerLossParams[0].FodNormalizationParams[1].QuadraticParams[1].swLinearCoefficient`

CB2 Exponent (NB2)

Details:

This parameter is the value of the exponent used to scale the CB2 coefficient to obtain an integer value in units of mW/mW.

Default Value: 0x15

Min Value: 0

Max Value: 65535

Member:

`NvmParams.CalParams.PowerLossParams[0].FodNormalizationParams[1].QuadraticParams[1].swLinearExponent`

CB3 – Constant Term for region B (mW)

Details:

This parameter represents the constant term of the equation used to calculate the normalization for system power losses (represented in mW).

Default Value: 0xFFCF

Min Value: -32768

Max Value: 32767

Member:

`NvmParams.CalParams.PowerLossParams[0].FodNormalizationParams[1].QuadraticParams[1].swConstantCoefficient`

CC1 – Quadratic Coefficient for region C (mW/mW² x 2^{NC1})

Details:

This parameter defines the quadratic coefficient of the equation used to calculate the normalization for system power losses represented in units of mW/mW² multiplied by the value of 2^{NC1} , where NC1 is the exponent defined by the next parameter.

Default Value: 0x9354

Min Value: -32768

Max Value: 32767

Member:

`NvmParams.CalParams.PowerLossParams[0].FodNormalizationParams[1].QuadraticParams[2].swQuadraticCoefficient`

CC1 Exponent (NC1)

Details:

This parameter is the value of the exponent used to scale the CC1 coefficient to obtain an integer value in units of mW/mW².

Default Value: 0x1F

Min Value: 0

Max Value: 65535

Member:

NvmParams.CalParams.PowerLossParams[0].FodNormalizationParams[1].QuadraticParams[2].wQuadExponent

CC2 – Linear Coefficient for region C(mW/mW x 2^{NC2})

Details:

This parameter defines the linear coefficient of the equation used to calculate the normalization for system power losses represented in units of mW/mW multiplied by the value of 2^{NC2}, where NC2 is the exponent defined by the next parameter.

Default Value: 0x72EB

Min Value: -32768

Max Value: 32767

Member:

NvmParams.CalParams.PowerLossParams[0].FodNormalizationParams[1].QuadraticParams[2].swLinearCoefficient

CC2 Exponent (NC2)

Details:

This parameter is the value of the exponent used to scale the CC2 coefficient to obtain an integer value in units of mW/mW.

Default Value: 0x15

Min Value: 0

Max Value: 65535

Member:

NvmParams.CalParams.PowerLossParams[0].FodNormalizationParams[1].QuadraticParams[2].wLinearExponent

CC3 – Constant Term for region C (mW)

Details:

This parameter represents the constant term of the equation used to calculate the normalization for system power losses (represented in mW).

Default Value: 0xFFCF

Min Value: -32768

Max Value: 32767

Member:

NvmParams.CalParams.PowerLossParams[0].FodNormalizationParams[1].QuadraticParams[2].swConstantCoefficient

Normalization Region A Breakpoint (mW)

Details:

This parameter defines the maximum Received Power in mW for Normalization Region A

Default Value: 1759

Min Value: 0

Max Value: 200000

Member:

`NvmParams.CalParams.PowerLossParams[0].FodNormalizationParams[1].dwNormalizationBreakpoint[0]`

Normalization Region B Breakpoint (mW)

Details:

This parameter defines the maximum Received Power in mW for Normalization Region B

Default Value: 4126

Min Value: 0

Max Value: 200000

Member:

`NvmParams.CalParams.PowerLossParams[0].FodNormalizationParams[1].dwNormalizationBreakpoint[1]`

CA1 – Quadratic Coefficient for region A(mW/mW² x 2^{NA1})

Details:

This parameter defines the quadratic coefficient of the equation used to calculate the normalization for system power losses represented in units of mW/mW² multiplied by the value of 2^{NA1}, where NA1 is the exponent defined by the next parameter.

Default Value: 0x9537

Min Value: -32768

Max Value: 32767

Member:

`NvmParams.CalParams.PowerLossParams[0].FodNormalizationParams[2].QuadraticParams[0].swQuadCoefficient`

CA1 Exponent (NA1)

Details:

This parameter is the value of the exponent used to scale the CA1 coefficient to obtain an integer value in units of mW/mW².

Default Value: 0x1F

Min Value: 0

Max Value: 65535

Member:

`NvmParams.CalParams.PowerLossParams[0].FodNormalizationParams[2].QuadraticParams[0].wQuadExponent`

CA2 – Linear Coefficient for region A(mW/mW x 2^{NA2})

Details:

This parameter defines the linear coefficient of the equation used to calculate the normalization for system power losses represented in units of mW/mW multiplied by the value of 2^{NA2}, where NA2 is the exponent defined by the next parameter.

Default Value: 0x561F

Min Value: -32768

Max Value: 32767

Member:

`NvmParams.CalParams.PowerLossParams[0].FodNormalizationParams[2].QuadraticParams[0].swLinearCoefficient`

CA2 Exponent (NA2)**Details:**

This parameter is the value of the exponent used to scale the CA2 coefficient to obtain an integer value in units of mW/mW.

Default Value: 0x14

Min Value: 0

Max Value: 65535

Member:

`NvmParams.CalParams.PowerLossParams[0].FodNormalizationParams[2].QuadraticParams[0].wLinearExponent`

CA3 – Constant Term for region A (mW)**Details:**

This parameter represents the constant term of the equation used to calculate the normalization for system power losses (represented in mW).

Default Value: 0xFFC7

Min Value: -32768

Max Value: 32767

Member:

`NvmParams.CalParams.PowerLossParams[0].FodNormalizationParams[2].QuadraticParams[0].swConstantCoefficient`

CB1 – Quadratic Coefficient for region B(mW/mW² x 2^{NB1})**Details:**

This parameter defines the quadratic coefficient of the equation used to calculate the normalization for system power losses represented in units of mW/mW² multiplied by the value of 2^{NB1}, where NB1 is the exponent defined by the next parameter.

Default Value: 0x9537

Min Value: -32768

Max Value: 32767

Member:

`NvmParams.CalParams.PowerLossParams[0].FodNormalizationParams[2].QuadraticParams[1].swQuadCoefficient`

CB1 Exponent (NB1)**Details:**

This parameter is the value of the exponent used to scale the CB1 coefficient to obtain an integer value in units of mW/mW².

Default Value: 0x1F

Min Value: 0

Max Value: 65535

Member:

NvmParams.CalParams.PowerLossParams[0].FodNormalizationParams[2].QuadraticParams[1].wQuadExponent

CB2 – Linear Coefficient for region B(mW/mW x 2^{NB2})

Details:

This parameter defines the linear coefficient of the equation used to calculate the normalization for system power losses represented in units of mW/mW multiplied by the value of 2^{NB2}, where NB2 is the exponent defined by the next parameter.

Default Value: 0x561F

Min Value: -32768

Max Value: 32767

Member:

NvmParams.CalParams.PowerLossParams[0].FodNormalizationParams[2].QuadraticParams[1].swLinearCoefficient

CB2 Exponent (NB2)

Details:

This parameter is the value of the exponent used to scale the CB2 coefficient to obtain an integer value in units of mW/mW.

Default Value: 0x14

Min Value: 0

Max Value: 65535

Member:

NvmParams.CalParams.PowerLossParams[0].FodNormalizationParams[2].QuadraticParams[1].wLinearExponent

CB3 – Constant Term for region B (mW)

Details:

This parameter represents the constant term of the equation used to calculate the normalization for system power losses (represented in mW).

Default Value: 0xFFC7

Min Value: -32768

Max Value: 32767

Member:

NvmParams.CalParams.PowerLossParams[0].FodNormalizationParams[2].QuadraticParams[1].swConstantCoefficient

CC1 – Quadratic Coefficient for region C(mW/mW² x 2^{NC1})

Details:

This parameter defines the quadratic coefficient of the equation used to calculate the normalization for system power losses represented in units of mW/mW² multiplied by the value of 2^{NC1}, where NC1 is the exponent defined by the next parameter.

Default Value: 0x9537

Min Value: -32768

Max Value: 32767

Member:

NvmParams.CalParams.PowerLossParams[0].FodNormalizationParams[2].QuadraticParams[2].swQuadCoefficient

CC1 Exponent (NC1)

Details:

This parameter is the value of the exponent used to scale the CC1 coefficient to obtain an integer value in units of mW/mW².

Default Value: 0x1F

Min Value: 0

Max Value: 65535

Member:

NvmParams.CalParams.PowerLossParams[0].FodNormalizationParams[2].QuadraticParams[2].wQuadExponent

CC2 – Linear Coefficient for region C (mW/mW x 2^{NC2})

Details:

This parameter defines the linear coefficient of the equation used to calculate the normalization for system power losses represented in units of mW/mW multiplied by the value of 2^{NC2}, where NC2 is the exponent defined by the next parameter.

Default Value: 0x561F

Min Value: -32768

Max Value: 32767

Member:

NvmParams.CalParams.PowerLossParams[0].FodNormalizationParams[2].QuadraticParams[2].swLinearCoefficient

CC2 Exponent (NC2)

Details:

This parameter is the value of the exponent used to scale the CC2 coefficient to obtain an integer value in units of mW/mW.

Default Value: 0x14

Min Value: 0

Max Value: 65535

Member:

NvmParams.CalParams.PowerLossParams[0].FodNormalizationParams[2].QuadraticParams[2].wLinearExponent

CC3 – Constant Term for region C (mW)

Details:

This parameter represents the constant term of the equation used to calculate the normalization for system power losses (represented in mW).

Default Value: 0xFFC7

Min Value: -32768

Max Value: 32767

Member:

NvmParams.CalParams.PowerLossParams[0].FodNormalizationParams[2].QuadraticParams[2].swConstantCoefficient

Normalization Region A Breakpoint (mW)

Details:

This parameter defines the maximum Received Power in mW for Normalization Region A

Default Value: 1773

Min Value: 0

Max Value: 200000

Member:

`NvmParams.CalParams.PowerLossParams[0].FodNormalizationParams[2].dwNormalizationBreakpoint[0]`

Normalization Region B Breakpoint (mW)

Details:

This parameter defines the maximum Received Power in mW for Normalization Region B

Default Value: 4171

Min Value: 0

Max Value: 200000

Member:

`NvmParams.CalParams.PowerLossParams[0].FodNormalizationParams[2].dwNormalizationBreakpoint[1]`

4 Revision History

The following table provides the revision history.

Table 24 Revision history

Revision number	Date	Substantive changes
0	05/2016	Initial release

How to Reach Us:

Home Page:

nxp.com

Web Support:

nxp.com/support

Information in this document is provided solely to enable system and software implementers to use Freescale products. There are no express or implied copyright licenses granted hereunder to design or fabricate any integrated circuits based on the information in this document.

Freescale reserves the right to make changes without further notice to any products herein. Freescale makes no warranty, representation, or guarantee regarding the suitability of its products for any particular purpose, nor does Freescale assume any liability arising out of the application or use of any product or circuit, and specifically disclaims any and all liability, including without limitation consequential or incidental damages. "Typical" parameters that may be provided in Freescale data sheets and/or specifications can and do vary in different applications, and actual performance may vary over time. All operating parameters, including "typicals," must be validated for each customer application by customer's technical experts. Freescale does not convey any license under its patent rights nor the rights of others. Freescale sells products pursuant to standard terms and conditions of sale, which can be found at the following address: freescale.com/SalesTermsandConditions.

Freescale and the Freescale logo are trademarks of Freescale Semiconductor, Inc., Reg. U.S. Pat. & Tm. Off. All other product or service names are the property of their respective owners.

© 2016 Freescale Semiconductor, Inc.

Document Number: WCT100XAV40RTDUG

Rev. 0

05/2016

