

MMA865xFC Sensor Toolbox User's Guide

1 Introduction

The Freescale MMA865xFC sensor toolbox accelerometer kit provides hardware and software for the demonstration and evaluation of the Xtrinsic MMA865xFC accelerometers (MMA8652FC, MMA8653FC). This user's guide shows you how to use this kit.

The MMA865xFC kit includes the following:

- MMA865x interface board
- MMA8652FC accelerometer daughter board
- MMA8653FC accelerometer daughter board

The kit requires a USB-interface board to attach the kit to a personal computer. Both items can be purchased on the [Freescale website](#).

- MMA865xFC kit, part number LFSTBEB865x
- MMA865x USB-interface board, part number LFSTBUSB
- Optional 9V battery board (for non-volatile memory datalogging), part number LFSTBBAT9

Contents

1	Introduction	1
2	About the MMA865x Accelerometers	2
3	Getting Started	3
3.1	Connecting the kit	3
3.2	Installing the sensor toolbox software	4
4	Understanding the Accelerometer Demonstrations	8
4.1	Opening the sensor toolbox software	8
4.2	Directional Flick application	10
4.3	Tilt Detection application	14
4.4	Orientation application	17
4.5	Graphical Datalogger application	21
4.6	NVM Datalogger application	26
4.7	Configuration screen	29
4.8	Directional Tap with FIFO application	31
4.9	Directional Shake with FIFO application	36
4.10	Full-System Evaluation application	41
5	Running the Accelerometer Demonstrations	62
5.1	Directional Flick application	62
5.2	Orientation (Portrait/Landscape) application	62
5.3	Graphical Datalogger application	62
5.4	Non-Volatile Memory Datalogger application	63
5.5	Directional Tap with FIFO application	63
5.6	Directional Shake with FIFO application	63
6	Revision History	64

2 About the MMA865x Accelerometers

The MMA8652FC device provides 12 bits of resolution and more features. The MMA8653FC device provides 10 bits of resolution with fewer features. For more information, also see the MMA865xFC data sheet.

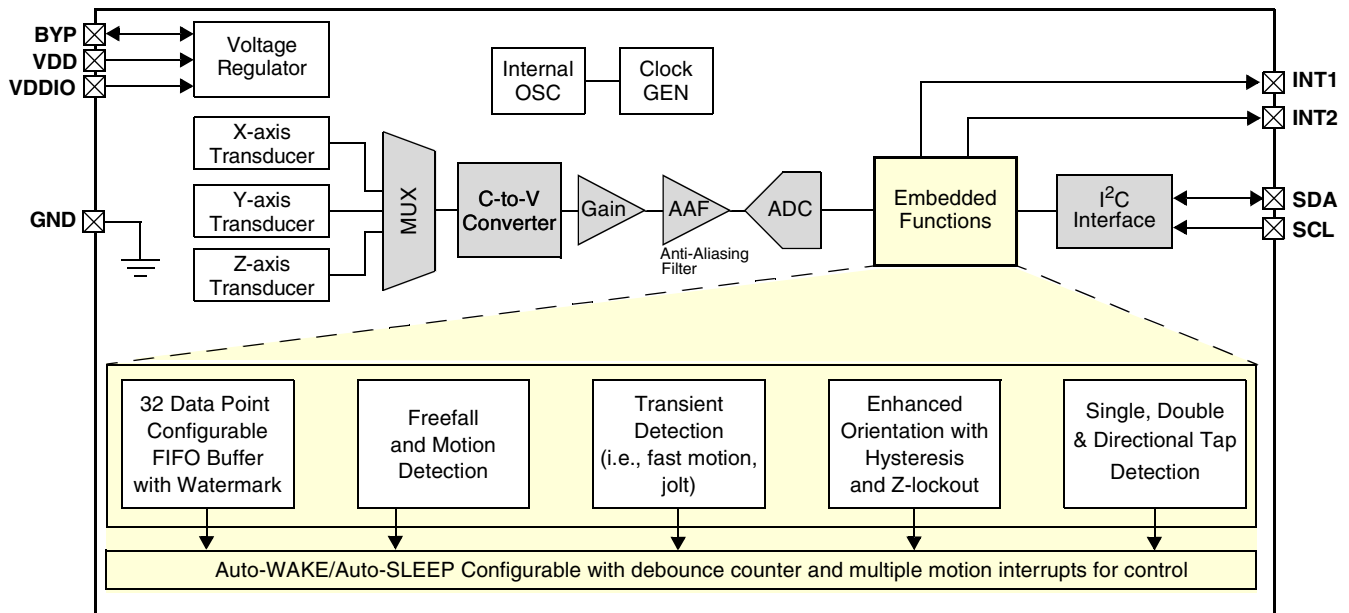

Figure 1. MMA8652 block diagram

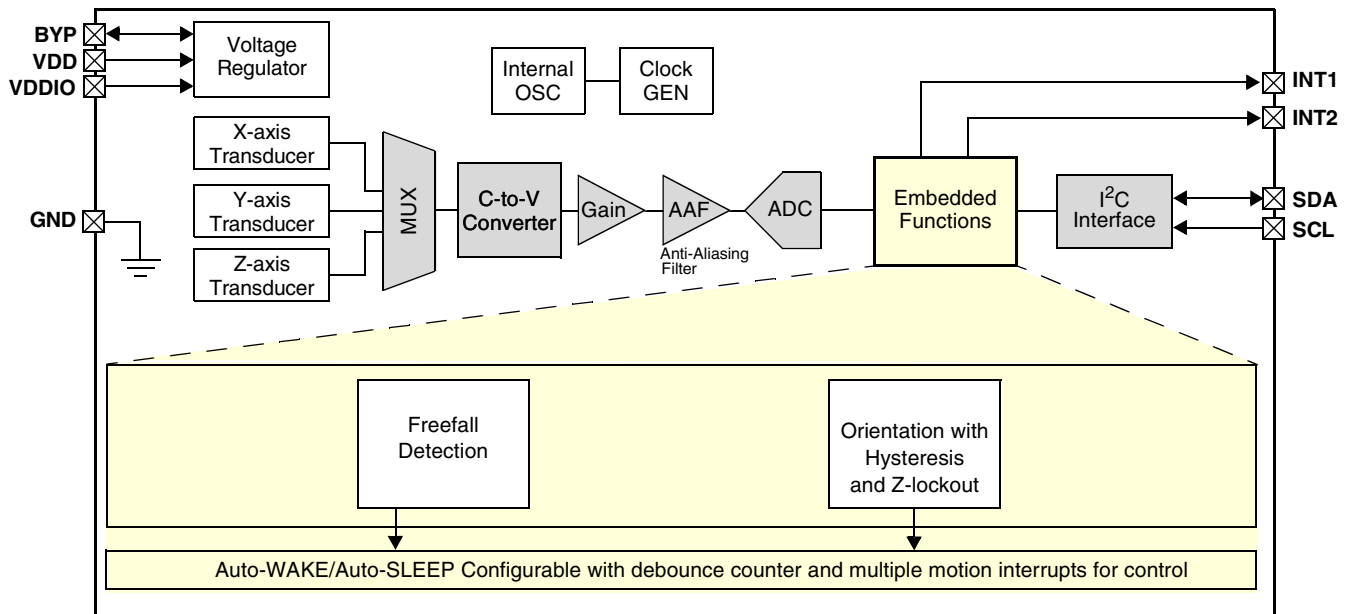

Figure 2. MMA8653 block diagram

3 Getting Started

To begin using the kit, connect it to your PC (Section 3.1, “Connecting the kit”) and install the sensor toolbox software (Section 3.2, “Installing the sensor toolbox software”).

3.1 Connecting the kit

Select one of the two daughter boards and attach it to the USB interface board, as directed in the *LFSTBEB8491 Quick Start Guide* included with the boards. When assembled, the device detection axes are as shown in Figure 3.

How the 3 axes are mapped to the MMA865xFC kit

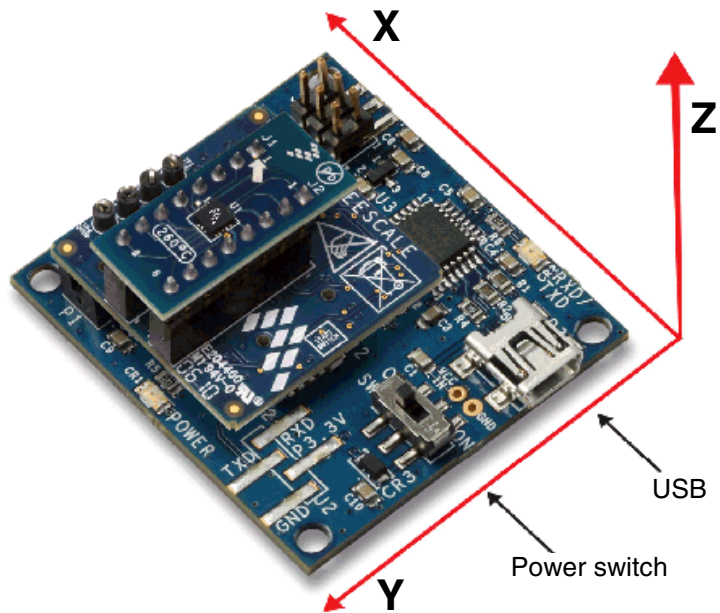

Figure 3. Board assemblies

Figure 4 shows how the boards of the MMA865xFC kit fit together.

**MMA8652FC (or MMA8653FC)
accelerometer board**

MMA845x interface board

**MMA865x USB-interface board
(LFSTBUSB)**

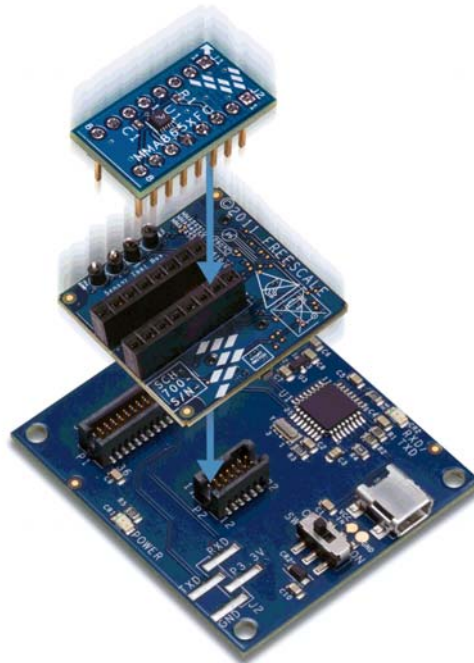

Figure 4. How the three boards are connected together

Connect the LFSTBUSB USB-interface board to a spare USB port on a Windows-based PC, using the USB cable that comes with the USB board. If the board's red power LED does not illuminate, check the board's power switch, near its USB connector.

3.2 Installing the sensor toolbox software

Perform the following procedure to install the software.

Near the end of this process, you will be asked if you want to install a serial-to-USB driver included with the sensor toolbox. If you have been previously used Freescale's sensor toolbox software, these drivers already are installed on your PC.

1. To download the sensor toolbox software, click the following link:

<http://www.freescale.com/sensortoolbox>.

The webpage, shown next, appears.

Sensor Toolbox



Freescale offers the Sensor Toolbox that provides a customizable selection of sensor development tools, accessories and software from Freescale's portfolio of acceleration, pressure and proximity touch sensors which enrich designs with a broad range of capabilities in detecting real-world conditions, such as motion, touch or pressure.

[Download Software](#) *Required for all Sensor Toolbox boards*

2. Click the Download Software button.
The Sensor Toolbox Installer license agreement page appears.
3. Scroll down to the bottom of the page, shown below, and click the I Accept button.

SEVERABILITY. If any provision of this Agreement is held for any reason to be invalid or unenforceable, then the remaining provisions of this Agreement will be unimpaired and, unless a modification or replacement of the invalid or unenforceable provision is further held to deprive you or Freescale of a material benefit, in which case the Agreement will immediately terminate, the invalid or unenforceable provision will be replaced with a provision that is valid and enforceable and that comes closest to the intention underlying the invalid or unenforceable provision.

NO WAIVER. The waiver by Freescale of any breach of any provision of this Agreement will not operate or be construed as a waiver of any other or a subsequent breach of the same or a different provision.

4. Save the software's installation executable file (SensorToolboxInstaller.exe) to your PC.
5. If you have not already connected the toolkit to your PC, perform the procedure in [Section 3.1, "Connecting the kit"](#).
6. Locate the installation file on your PC and double-click on it.
7. Proceed through the setup wizard's series of dialog boxes.
During the process, you will be asked if you want a Sensor Toolbox icon added to your Start menu and desktop.

8. When the Ready to Install dialog box, shown below, appears, review the installation configuration and click the Install button.

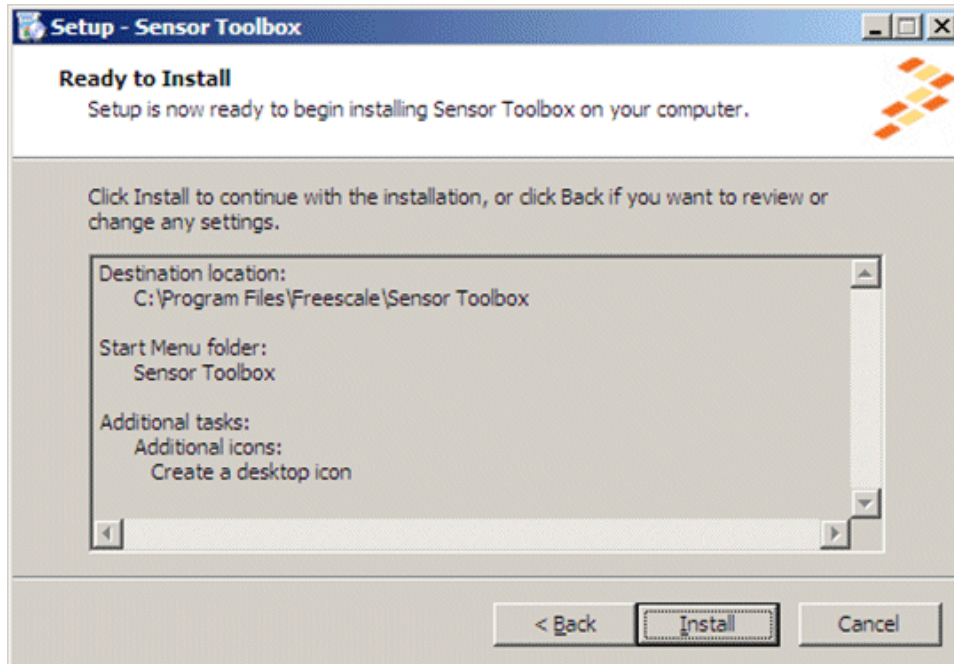

A progress bar displays the status of the software installation and the final dialog box, shown below, appears.

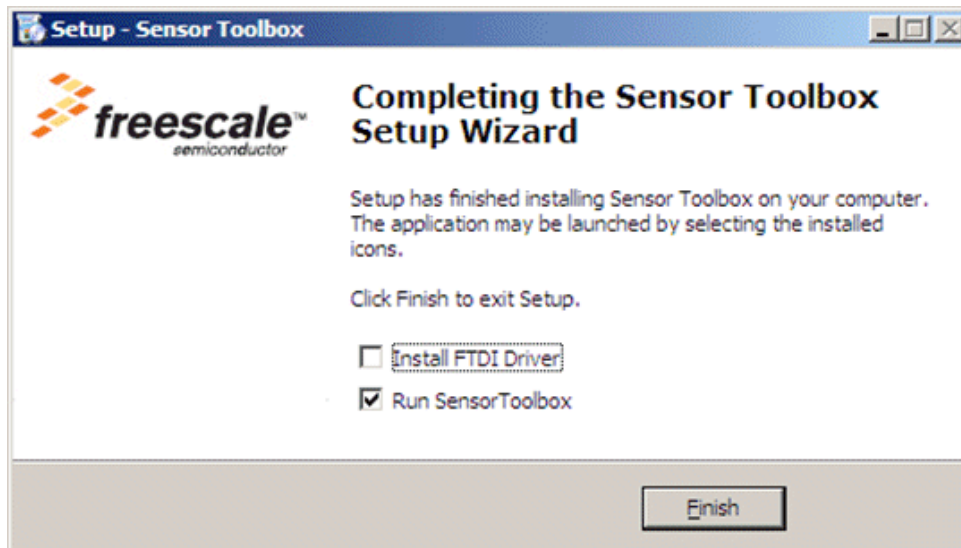

9. Do any of the following and click the Finish button:

- To install the Future Technology Devices International (FTDI) serial-to-USB communications driver, enable the Install FTDI Driver checkbox.
- To launch the toolbox software upon completion of the setup, leave the Run Sensor Toolbox checkbox enabled.

If you chose to install the FTDI driver, a command-line window briefly appears.

The application is now ready for use.

4 Understanding the Accelerometer Demonstrations

The sensor toolbox has several demonstrations for the MMA865xQ accelerometers, each showcasing the built-in intelligence of the individual devices. The demos include tilt detection, orientation detection, directional tap, and directional shake. There also is a full-system evaluation mode that allows you to evaluate the sensor at the register level.

4.1 Opening the sensor toolbox software

To launch the toolbox software, either double-click on the application's desktop icon or choose Start > Programs > Sensor Toolbox > Sensor Toolbox. This displays the sensor toolbox's hardware-detection dialog box, shown below.



If the LFSTBUSB USB-interface board is connected properly, then the software will detect which of the MMA865xQ daughter boards is attached to the evaluation board, and display the device-specific menus. Upon device connection, the software displays the demo launcher menu, shown in the next illustration.

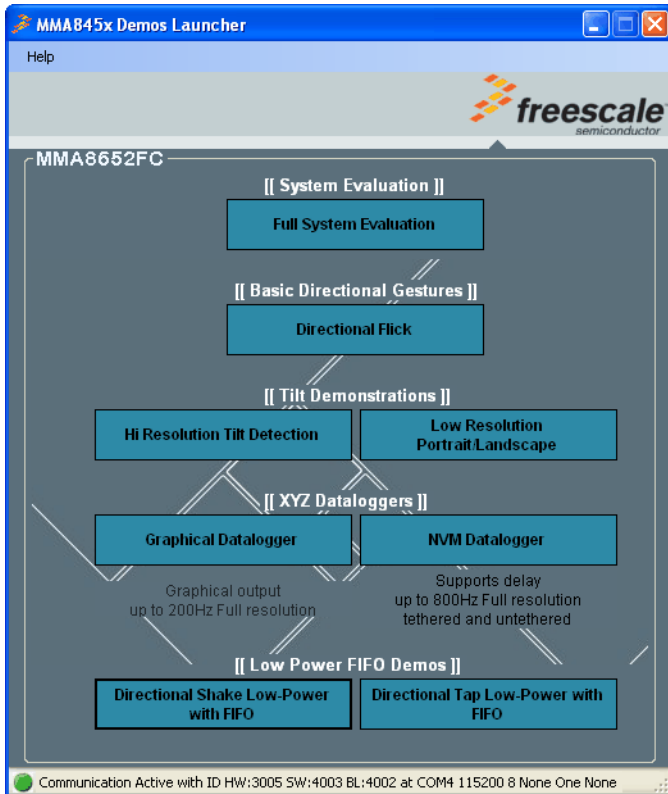

Full System Evaluation	page 41
Directional Flick	page 10
Hi Resolution Tilt Detection	page 14 (MMA8652 only)
Low Resolution Portrait/Landscape	page 17
Graphical Datalogger	page 21
NVM Datalogger	page 26
Directional Shake Low-Power with FIFO	page 36 (MMA8652 only)
Directional Tap Low-Power with FIFO	page 31 (MMA8652 only)

- To launch a demo, click on its box.
- To navigate to a different demo, close the browser window for the current demo and click on a different demo box in the launcher menu, which remains in the background as long as the application is running.

4.2 Directional Flick application

This demo enables you to evaluate the built-in algorithm for detecting flicks (transient events) with both accelerometers. You can evaluate Freescale's default configuration and modify those settings to tailor a demonstration to your target application.

Launching the demo displays the Active screen.

4.2.1 Active screen

The Active screen contains a Direction Event Detected indicator with a direction text display, a picture showing how to hold the device, and some pictures that can be manipulated by flicking the device. The flick must be done in the direction indicated by the red arrow.

Note: Before changing any of the Active screen's settings, select the Standby option button.

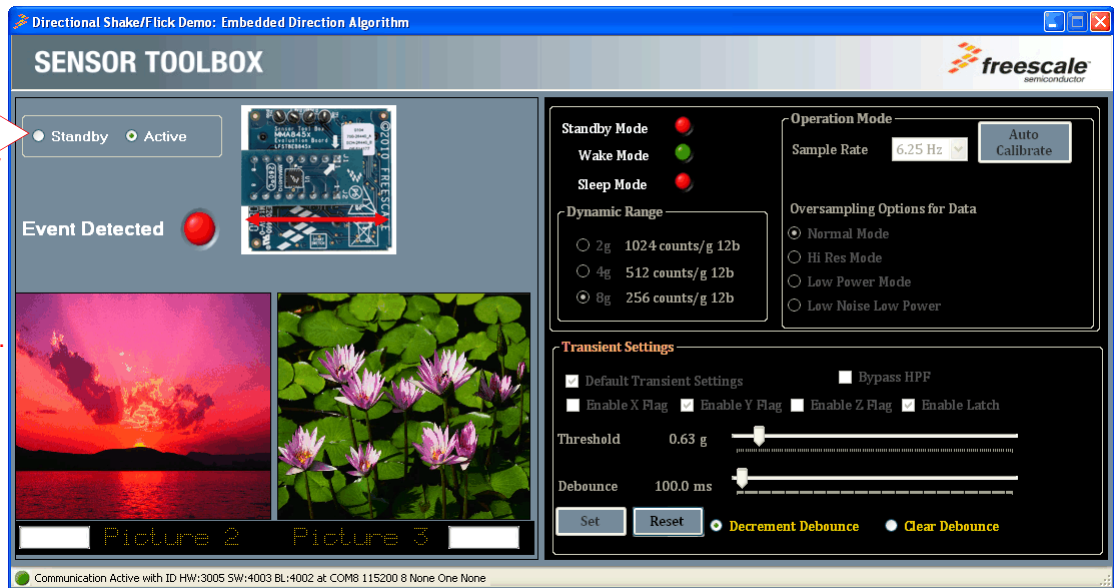

4.2.2 Standby screen

Use the Standby screen to:

- Change the sample rate of the device
- Set the dynamic range
- Change the over-sampling setting
- Calibrate the device
- Change the device state and the parameters for detecting transient events

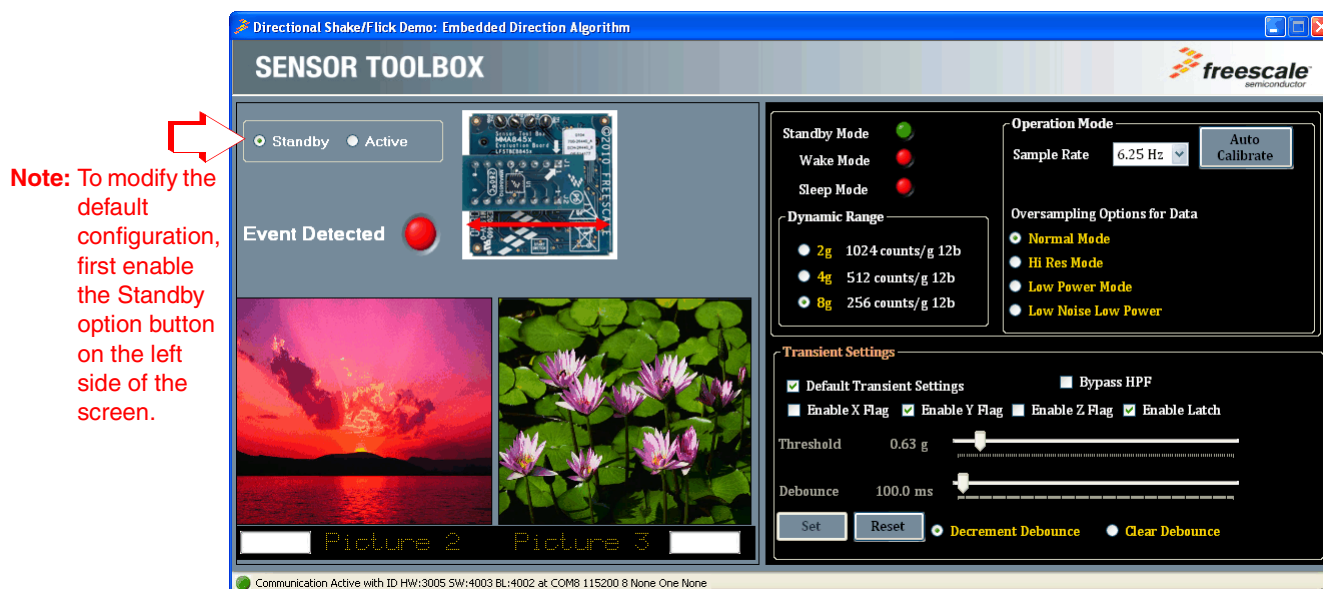

The screen contains the following menu frames:

- Standby Active
- Operation Mode
- Dynamic Range
- Transient Settings

NOTE

Before changing any settings, enable Standby mode, because the settings cannot be changed in Active mode.

After changing any configuration settings, enable Active mode, to register the new settings with the device.

Table 1. Directional Flick – Active/Standby screens

Screen frame	Field or option	Description	
Operation Mode	Sample Rate	Enables you to change the rate at which the device acquires data.	
	Over-Sampling Options for Data	Normal Mode	Normal operation.
		Hi Res Mode	The device gives more accurate readings, but draws more current.
		Low Power Mode	The device draws less current than Normal mode, but at the expense of accuracy.
		Low Noise Low Power	The device draws more current Normal mode, but less than Low Power mode and reduces noise.
Auto Calibrate	Directs the device to calculate the offsets for each axis (account for any error in measurements). For maximum resolution, the calibration is done with a dynamic range of 8g and a sample rate of 1.563 Hz. Note: Before enabling this mode, place the device on a flat and stationary surface.		
Dynamic Range	<ul style="list-style-type: none"> • 2g • 4g • 8g 	Sets the range over which the accelerometer is acquiring data.	
Standby Active	Standby	Sets the device to Standby mode.	
	Active	Sets the device to Active mode.	
	<ul style="list-style-type: none"> • Standby Mode • Wake Mode • Sleep Mode 	Indicates the device's status (Read only). Note: The device will never enter Sleep mode during this demo.	
Transient Settings	Default Transient Settings	Sets the parameters for detecting flicks to their working values, as defined at the factory.	
	Bypass HPF (High-Pass Filter)	Directs the application to use the raw accelerometer data before it has been passed through the HPF. Note: The Bypass HPF setting should normally be disabled.	
	<ul style="list-style-type: none"> • Enable X Flag • Enable Y Flag • Enable Z Flag 	Allows flicks along these axes to trigger the “Event Detected” Indicator on the Demo Screen. Note: Only the Y axis will move the pictures and correctly trigger the direction indicator. If enabled, the X and Z axes will only trigger the Event Detected indicator on the Demo screen.	
	Enable Latch	Causes any triggered event to remain until the Status register is read. If this checkbox is not enabled, the interrupt will only last as long as the event and the Status register will represent the most-recent event. This setting should be enabled for the flick detection to work properly. If it is disabled, the events that are moving the pictures will constantly occur as you move the device and the pictures will simply flick from end to end.	

Table 1. Directional Flick – Active/Standby screens (Continued)

Screen frame	Field or option	Description
Transient Settings (continued)	Threshold	Sets the threshold for flick events to be detected. Flicks at a smaller g-force than this value are filtered out. To move the slider, the Reset button must be clicked. After the selection is made, click the Set button to change the setting.
	Debounce	This slider sets the amount of time that the configured conditions must be in place to trigger the main flick event. Any event whose duration does not exceed this time will not trigger an interrupt. To move the slider, the Reset button must be clicked. After the selection is made, click the Set button to change the setting.
	Decrement Debounce	Selecting this option causes the Debounce timer to be decremented each time an event fails to reach the debounce time.
	Clear Debounce	Selecting this option causes the timer set by the Debounce slider to reset each time an event fails to reach the debounce time.
	Set	Saves the new configuration settings after the repositioning of the Threshold and Debounce sliders.
	Reset	Enables the moving of the Threshold and Debounce sliders.

4.3 Tilt Detection application

This tilt demo enables you to evaluate the tilt application using both accelerometers' data. It showcases the tilt detection on the X and Y axes. The tilt angle degree is the addition of the coarse and the fine readings:

- The coarse reading is the integer angle.
- The fine reading is the fractional angle (also known as arcminutes).

4.3.1 Active screen

The Active screen enables you to evaluate the built-in algorithm for detecting the device's tilt, in conjunction with the device's resolution mode (coarse or fine). You can evaluate the default configuration and modify the settings to tailor the demonstration to your target application.

Note: Before changing any of the Active screen's settings, select the Standby option button.

Note: In order for the tilt to be registered, the device must be held up so that it is facing you (or held on a desk on its edge).

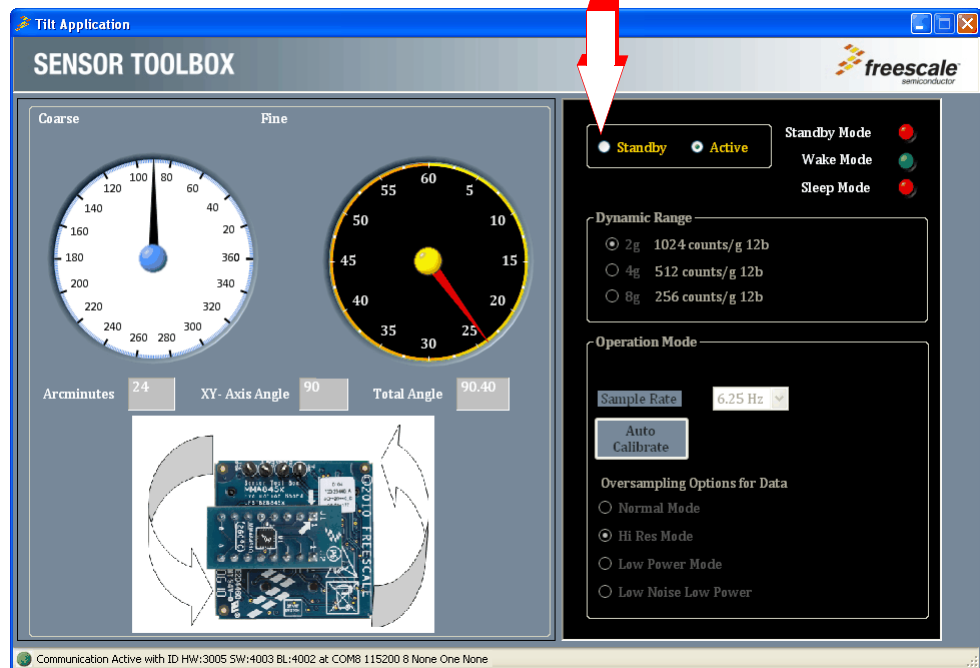

4.3.2 Standby screen

Use the Standby screen to:

- Change the device Standby/Active state
- Set the dynamic range
- Change the sample rate of the device
- Change the over-sampling setting

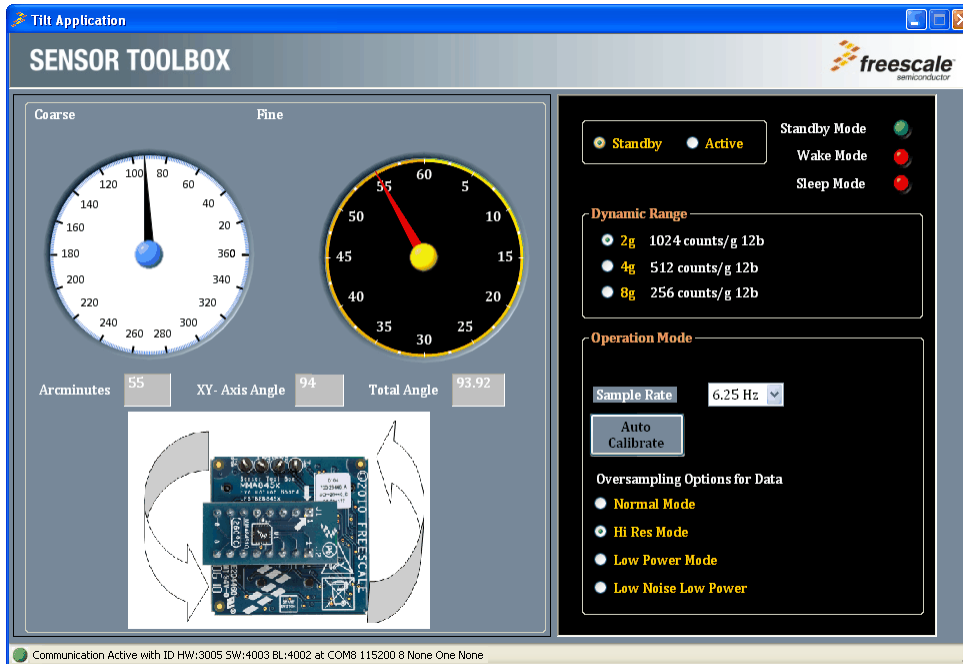

NOTE

Before changing any settings, enable Standby mode, because the settings cannot be changed in Active mode.

After changing any configuration settings, enable Active mode, to register the new settings with the device.

Table 2. Tilt Detection – Active/Standby screens

Screen frame	Field or option	Description
Tilt Angle Degree	Coarse	Indicates the angle the device is being held at, along the X and Y axes (degrees).
	Fine	Shows the Arcminutes value of the angle (where an arcminute is equal to 1/60 of a degree).

Table 2. Tilt Detection – Active/Standby screens (Continued)

Screen frame	Field or option	Description	
Operation Mode	Sample Rate	Enables you to change the rate at which the device acquires data. Note: The tilt demo will not function at the 1.563 Hz Sample Rate.	
	Over-Sampling Options for Data	Normal Mode	Normal operation.
		Hi Res Mode	The device gives more accurate readings, but draws more current.
		Low Power Mode	The device draws less current than Normal mode does, but at the expense of accuracy.
		Low Noise Low Power	The device draws more current than Normal mode does, but less current than Low Power mode does, and reduces noise.
Auto Calibrate	Directs the device to calculate the offsets for each axis (accounting for any error in measurements). For maximum resolution, the calibration is done with a dynamic range of 8g and a sample rate of 1.563 Hz. Note: Before enabling Auto Calibrate mode, place the device on a flat and stationary surface. Note: Before returning to active mode, it is necessary to set the Sample Rate back to a usable value, because running Auto Calibrate sets the device to the 1.563 Hz Sample Rate (a frequency at which the tilt application cannot function).		
Dynamic Range	<ul style="list-style-type: none"> • 2g • 4g • 8g 	Sets the range over which the accelerometer is acquiring data.	
Standby Active	Standby	Sets the device to Standby mode.	
	Active	Sets the device to Active mode.	
	<ul style="list-style-type: none"> • Standby Mode • Wake Mode • Sleep Mode 	Indicates the device's status (Read only). Note: The device will never enter Sleep mode during this demo.	

4.4 Orientation application

The Orientation application demo enables you to evaluate the built-in Portrait/Landscape algorithm for detecting orientation. Using this application, you can evaluate Freescale's default configuration, as well as change the settings to tailor the demonstration to your target application

4.4.1 Active screen

The Active screen contains a Portrait/Landscape gauge and a Back/Front gauge. The Portrait/Landscape gauge has 5 options: UP, DOWN, LEFT, RIGHT, and Lockout. The Back/Front gauge shows 2 options: BACK/FRONT.

The image below the gauge is a simulated mobile phone that displays the same orientation indicated by the gauges. The information is provided by the device's accelerometer data.

Note: Before changing any of the Active screen's settings, select the Standby option button.



4.4.2 Standby screen

Use the Standby screen to:

- Set the device's Standby/Active state
- Set the dynamic range
- Change the sample rate of the device
- Change the over-sampling setting
- Change the parameters for detecting orientation changes

Note: Before changing the Orientation Detection values, select the Enable P/L button.

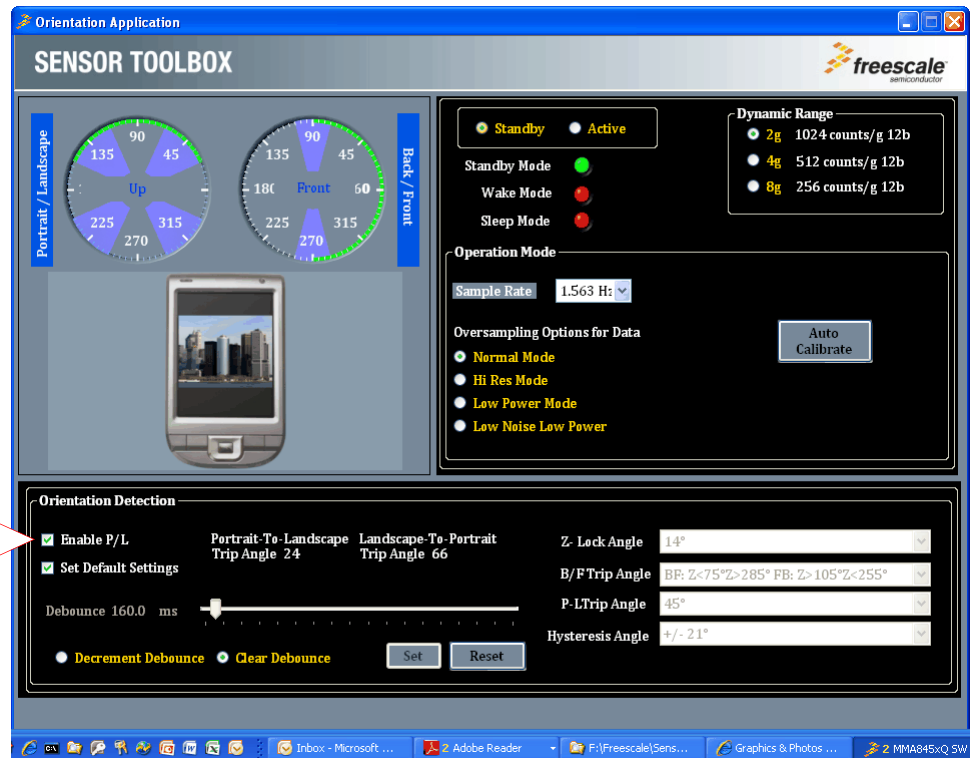
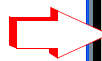

NOTE

Before changing any settings, enable Standby mode, because the settings cannot be changed in Active mode.

After changing any configuration settings, enable Active mode, to register the new settings with the device.

Each menu frame's fields and options are described in [Table 3](#).

Table 3. Orientation – Active/Standby screens

Screen frame	Field or option	Description	
Portrait / Landscape Detection Display	Portrait/Landscape	Shows the angle of the X and Y axes of the device. If the device is tilted past the Z-lockout angle, then changes in the X and Y axes are ignored and the gauge displays “Lock Out.” To resume orientation detection, rotate the device away from the Z-lockout angle.	
	Back/Front	Displays the Front/Back angle of the device.	
	Simulated Graphic Display (mobile phone)	Orients the phone at the angle indicated by the data from the accelerometer.	
Operation Mode	Sample Rate	Enables you to change the rate at which the device acquires data.	
	Over-Sampling Options for Data	Normal Mode	Normal operation.
		Hi Res Mode	The device gives more accurate readings, but draws more current.
		Low Power Mode	The device draws less current than Normal mode does, but at the expense of accuracy.
		Low Noise Low Power	The device draws more current than Normal mode does, but less current than Low Power mode does, and reduces noise.
Auto Calibrate	Directs the device to calculate the offsets for each axis (account for any error in measurements). For maximum resolution, the calibration is done with a dynamic range of 8g and a sample rate of 1.563 Hz. Note: Before enabling this mode, place the device on a flat and stationary surface.		
Dynamic Range	<ul style="list-style-type: none"> • 2g • 4g • 8g 	Sets the range over which the accelerometer is acquiring data.	
Standby Active	Standby	Sets the device to Standby mode.	
	Active	Sets the device to Active mode.	
	<ul style="list-style-type: none"> • Standby Mode • Wake Mode • Sleep Mode 	Indicates the device’s status. Note: The device will never enter Sleep mode during this demo.	

Table 3. Orientation – Active/Standby screens (Continued)

Screen frame	Field or option	Description
Orientation Detection settings	Enable P/L	Enables the frame's settings to be modified. Clearing the checkbox will prevent the demo from functioning.
	Set Default Settings	Resets the frame's settings to the default values defined at the factory. Note: Selecting the "Set Default Settings" option will lock the values in the text boxes to its right. If you want to change those values manually, then the "Set Default Settings" option must be de-selected.
	Portrait-To-Landscape Trip Angle	Shows the current value (Read only).
	Landscape-To-Portrait Trip Angle	Shows the current value (Read only).
	Z-Lock Angle	Changes the Z-axis angle at which the device will ignore changes in orientation. (For more information, see " Orientation application. ")
	B/F Trip Angle	(Back/Front Trip Angle) Changes the range of z-axis angles within which the device considers itself facing front and back.
	P-L Trip Angle	(Portrait-to-Landscape Trip Angle) Changes the <i>midpoint</i> of the angle at which the device will change from portrait to landscape orientation, or vice versa. <ul style="list-style-type: none"> For changing to right, the angle is measured down from the positive X axis. For changing to the left, landscape orientation, the angle is measured up from the X-axis.
	Hysteresis Angle	Changes the <i>distance from the midpoint</i> of the angle at which the device will change from portrait to landscape orientation, or vice versa. The actual trip angle for changing orientation is the P-L angle \pm this angle.
	Debounce	Changes the time that the device waits after a physical orientation change is detected, before triggering an orientation-change interrupt. To move the Debounce slider, the Reset button must be clicked. After the Debounce selection is made, click the Set button to change the setting.
	Decrement Debounce	Causes the Debounce timer to decrement each time that an event fails to reach the debounce time.
	Clear Debounce	Causes the timer set by the Debounce slider to reset each time that an event fails to reach the debounce time.
	Set	Saves the new configuration settings after the repositioning of the Threshold and Debounce sliders.
	Reset	Enables you to move the Threshold and Debounce sliders.

4.5 Graphical Datalogger application

This application generates a data log from the accelerometer and enables you to export it to a text file (.csv). This enables you to evaluate the device's default settings and any of your modifications, and to tailor the datalogger to your data-collection needs.

4.5.1 Main screen

The Main screen selects the data to be logged, and includes a drop-down menu for saving that data to a file.



Two additional screens can be displayed from the Main screen: the Configuration and Registers screens.

- To access the Registers screen, click the Registers button.
- To access the Configuration screen, point the mouse at the bottom of the screen.

Table 4. Graphical Datalogger – Main screen

Element	Description	
File drop-down menu	Select File > Save to save the graph's currently displayed data to a file at your specified location.	The data is saved as a Comma-Separated Values (*.csv) file, which can be viewed with any text-based or spreadsheet application.
	Select File > New to discard all of the previous data points.	
Registers	Opens the Registers section.	
Acceleration graph	Displays the data acquired by the accelerometer.	The data is acceleration (g value or counts) vs. time (seconds).
Start/Stop a New Datalog button	Starts logging the data acquired by the accelerometer and displays it in the graph. <ul style="list-style-type: none"> • To start the datalog, click the button (or use keyboard shortcut ctrl+N). The same button turns into "Stop current Datalog". • To stop the datalog, click the button. 	

Table 4. Graphical Datalogger – Main screen (Continued)

Element	Description	
<ul style="list-style-type: none"> • X-Axis • Y-Axis • Z-Axis Checkboxes	<ul style="list-style-type: none"> • Enabling a checkbox begins displaying accelerometer data for the specified axis. • Clearing the checkbox stops displaying the data. 	The legend items above each checkbox indicate the line colors for the respective axes.
Show G Values	Pushing this toggle up graphs the accelerometer's reading in g-values.	
Show Count Values	Pushing this toggle down graphs the accelerometer's reading in counts.	
Number of points	The number of points in the current graph.	
Configuration status bar	Configuration Active with	
	[MMA8652FC] ID	The device ID
	HW:3005	The kit's hardware revision number
	SW:4003	The kit's Sensor Toolbox software revision number
	BL:4002	The kit's MCU boot loader firmware revision number
	at COM3	The communications port that the device is using
	115200	The baud rate at which the device is communicating with the computer (PC)
	8 None One None	8 data bits, no parity, 1 stop bit, no error checking

4.5.2 Configuration screen

The Configuration screen gives you access to advanced options.

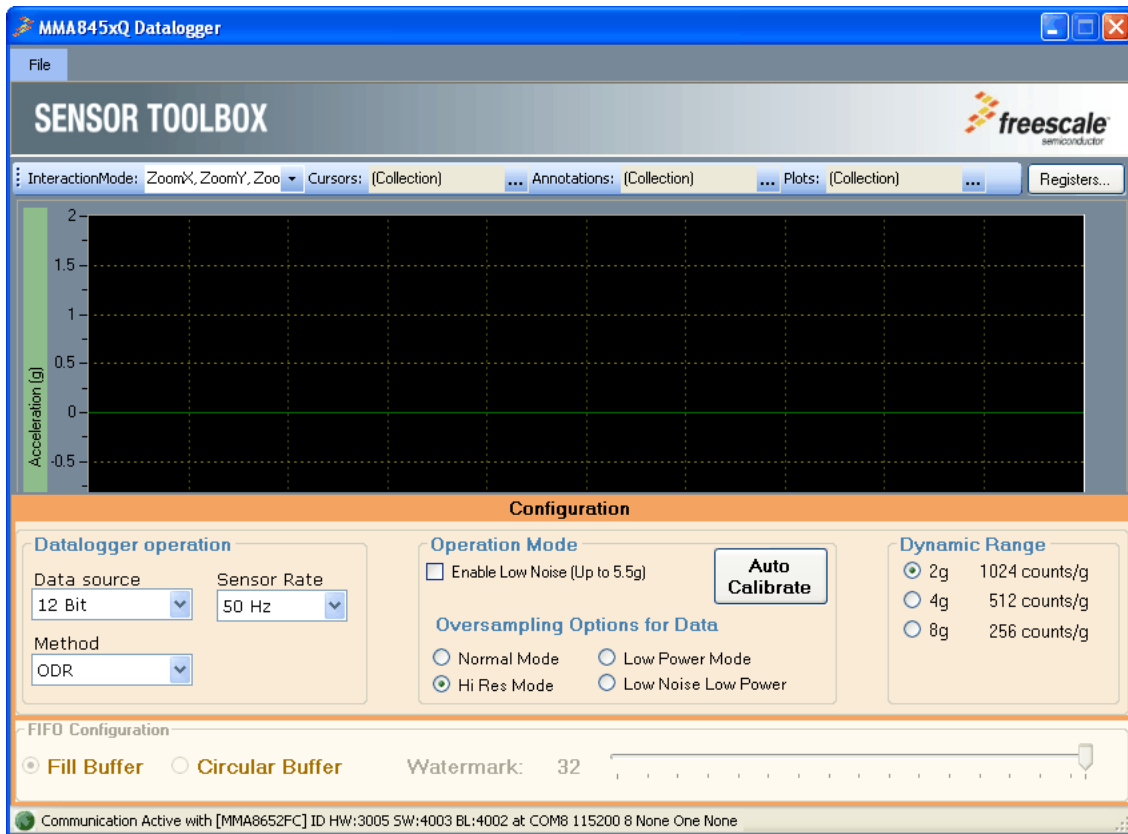
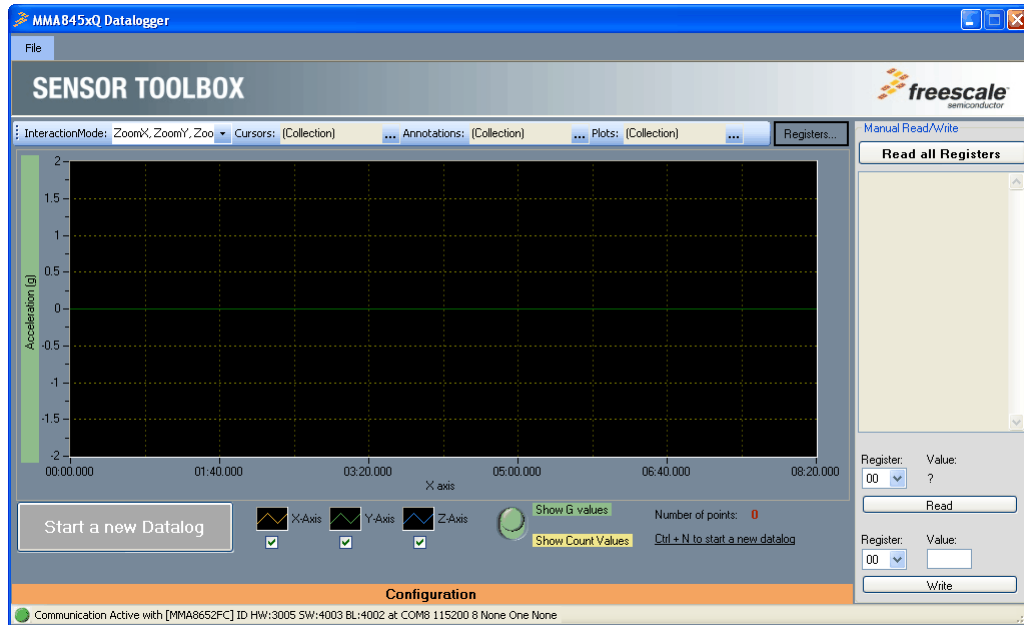

Table 5. Graphical Datalogger – Configuration screen

Screen frame	Field or option	Description	
Datalogger Operation	Data Source	Select the device's data reading resolution. A higher number of bits produces more-precise values, but it requires more time and power. <ul style="list-style-type: none"> • Selecting the 8-bit option causes the program to read only the 8 bits stored in the X, Y, and Z MSB registers. • Selecting 12 bits for the MMA8652FC reads the 8 MSB bits and the 4 bits stored in the X, Y, and Z LSB registers. • Selecting 10 bits for the MMA8653FC reads the 8 MSB bits and the 2 bits stored in the X, Y, and Z LSB registers. 	
	Method	This drop-down list enables you to select how the data is read from the device. <ul style="list-style-type: none"> • Select ODR to display data read directly from the device's output registers. • Select FIFO to display data collected in the device FIFO. To use the functions in the FIFO Configuration frame, the FIFO option must be selected.	
	Sensor Rate	This drop-down list enables you to select the rate that the accelerometer collects data at. Note: While sensor rate options above 200 Hz are included in the list (because the device is capable of operating at these rates), 200 Hz is the highest sensor rate at which the Datalogger can function— therefore these sensor rates will not be selectable in this application.	
Operation Mode	Enable Low Noise	Enables the device's Low Noise Mode for more accurate readings. Note: In Enable Low Noise mode, any g-force greater than $\pm 4g$ will not be read.	
	Over-Sampling Options for Data	Normal Mode	Normal operation.
		Hi Res Mode	The device gives more accurate readings, but draws more current.
		Low Power Mode	The device draws less current than Normal mode does, but at the expense of accuracy.
		Low Noise Low Power	The device draws more current than Normal mode does, but less current than Low Power mode does, and reduces noise.
Auto Calibrate	Directs the device to calculate the offsets for each axis (accounting for any error in measurements). For maximum resolution, the calibration is done with a dynamic range of 8g and a sample rate of 1.563 Hz. Note: Before enabling Auto Calibrate mode, place the device on a flat and stationary surface.		
Dynamic Range	<ul style="list-style-type: none"> • 2g • 4g • 8g 	Sets the range over which the accelerometer acquires data.	
FIFO Configuration	To use the functions in this frame, the Method drop-down field must be set to FIFO.		
	Fill Buffer option button	Fills the FIFO with data and then dumps that data to the Acceleration graph each time that the FIFO is full.	
	Circular Buffer option button	Fills the FIFO with data and then begins feeding it out from the beginning of the FIFO. This will cause a 32-point lag between when the data is acquired and when it is displayed on the graph.	
	Watermark slider	Set the sample number to be stored in the FIFO before the Watermark Flag is asserted.	

4.5.3 Registers screen

The Registers screen enables you to read from or write to any of the device's registers. For information about the functions and values of each register, see the MMA865xFC data sheet.



The Register tab contains three commands: read all registers, read individual register, and write individual register.

Table 4-1. Register tab commands

Command	Description
Read all registers	Click the button "read all registers" to read all. The register address and their values will be listed in the text box below.
Read an individual register	Select register address from the drop down box. Click the button "read". The register value will show under the text "value".
Write an individual register	Select register address from the drop down box. Type in the to-be-written register value in the text box under the text "value". Click the button "write" to write the value the register. As a good practice, you should always read the register to verify the write.

4.6 NVM Datalogger application

The Non-Volatile Memory (NVM) datalogger application enables you to make a log of data collected from the accelerometer (using the device's non-volatile memory), and export it (the data) to a text file. This enables you to evaluate the device's default settings and any of your modifications, for tailoring the datalogger for your data-collection needs.

NOTE

- The datalog is not erased when the device is powered off and on.
- When the NVM datalogger is started, a new piece of firmware is loaded onto the device to enable its use (you may see a Loader screen). When a new application is next opened, the firmware will be returned to normal (you will see the same screen again).

The application can collect the data, using either the device tethered to the computer with the USB cable or using a 9V battery board (LFSTBBAT9). The battery board can be purchased on [the Sensor Toolbox website](#).

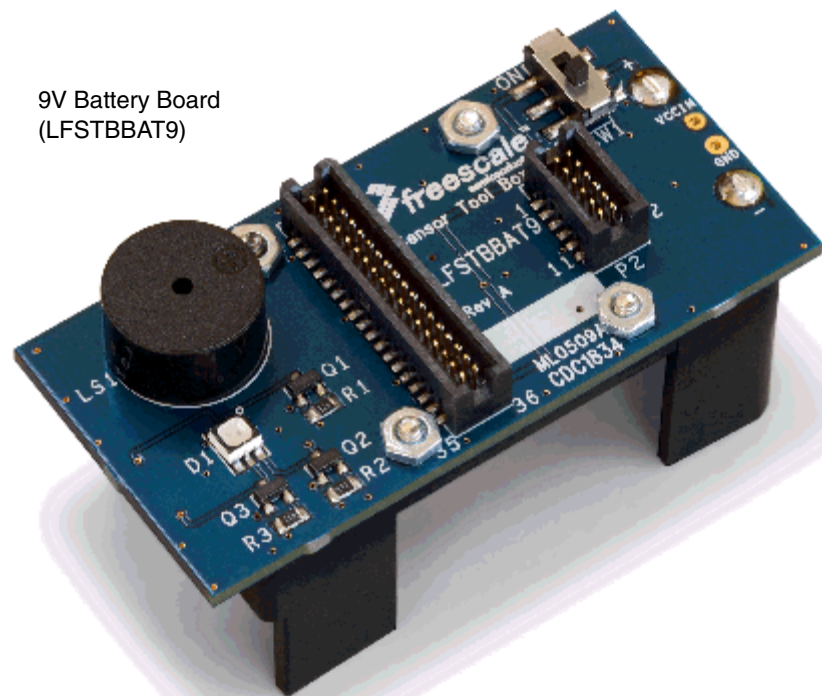

9V Battery Board
(LFSTBBAT9)

Figure 5. Battery board

4.6.1 Main screen

The Main screen enables you to start a new datalog, erase an existing datalog, or configure the datalog options.

To display the Configuration screen, move the mouse over that menu's heading, at the bottom of the main screen.

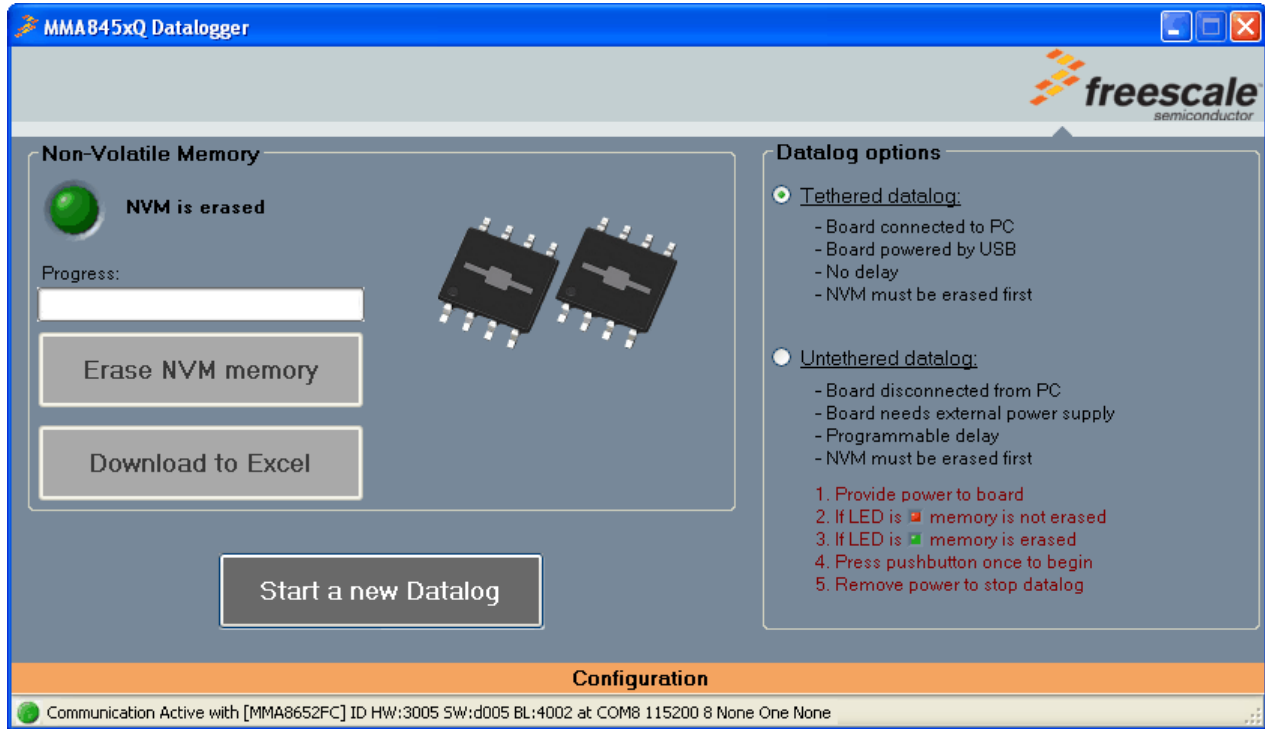

Table 6. NVW Datalogger – Main screen

Screen frame	Element	Description
Non-Volatile Memory	NVM is Erased status indicator	<ul style="list-style-type: none"> If green, the text “NVM is erased” is displayed, indicating that the device is ready to start a new datalog. If red, the text “NVM is not erased” is displayed, indicating that the device has stored a new datalog to memory. Pressing the “Erase NVM memory” button deletes all data currently stored in NVM, and returns the indicator to the green state.
	Progress indicator	Shows the progress of the “Erase NVM memory” or “Download to Excel” operation.
	Erase NVM memory button	Erases the non-volatile memory on the device. Note: Before a new datalog is started, the “Erase NVM memory” button must be clicked.
	Download to Excel button	Exports the data stored in the device’s NVM to a comma-separated-values (.csv) file, which can be opened with any spreadsheet or text application.

Table 6. NVW Datalogger – Main screen (Continued)

Screen frame	Element	Description
Datalog Options	Tethered Datalog	Collects data with the NVM while the device is still connected to the computer. The device will begin taking data as soon as the “Start a New Datalog” button is clicked.
	Untethered Datalog	Enables an external source to power the device while data is being collected in the NVM. (See Section 4.6.1.1, “Process for untethered dialog” , just after this table.)
Start a New Datalog	Starts a new datalog. Before using the “Start a New Datalog” function, the Erase NVM memory button must be clicked.	

4.6.1.1 Process for untethered dialog

1. If the NVM Status Indicator is not green, then click the Erase NVM Memory button.
2. Click the Start New Datalog button.
3. Disconnect the device from the computer and attach it to the external power source.
4. If you have configured a delay, then start the timer (by pressing the small button on the right side of the device).

For information about setting a delay, see Delay Options in [Table 7, “NVW Datalogger – Configuration screen,”](#) on page 29.

5. To download the data, reconnect the device to the computer and re-open the NVM Datalogger demo.

4.7 Configuration screen

The Configuration screen is displayed by moving the mouse pointer over the Configuration heading at the bottom of the main screen.

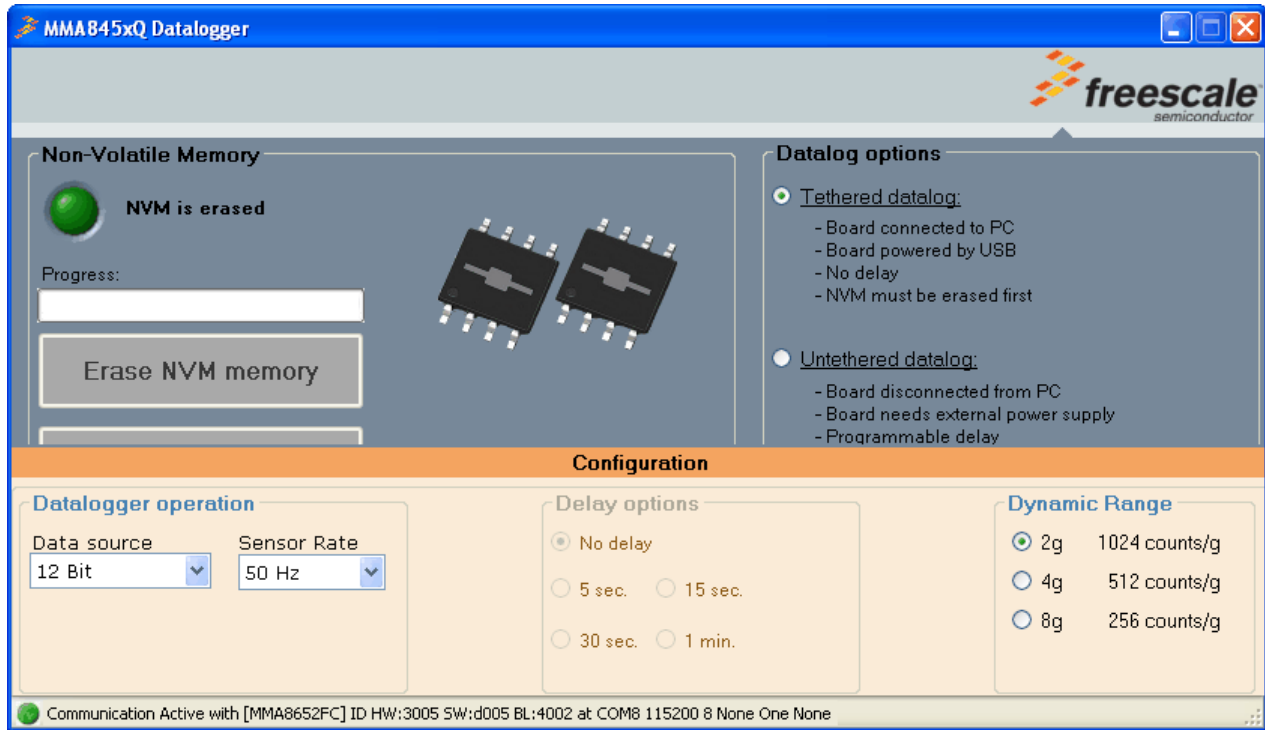

Table 7. NVW Datalogger – Configuration screen

Screen frame	Element	Description
Datalogger Operation	Data Source	<p>Selects the number of bits to be read from the device. A higher number of bits produces more-precise values, but requires more time and power.</p> <ul style="list-style-type: none"> Selecting the 8-bit option causes the program to read only the 8 bits stored in the X, Y, and Z MSB registers. Selecting 12 bits for the MMA8652FC reads the 8 MSB bits and the 4 bits stored in the X, Y, and Z LSB registers. Selecting 10 bits for the MMA8653FC reads the 8 MSB bits and the 2 bits stored in the X, Y, and Z LSB registers.
	Sensor Rate	This drop-down list enables you to select the rate at which the accelerometer acquires data.
Delay Options	No Delay	Disables the delay function.
	<ul style="list-style-type: none"> 5 sec 15 sec 30 sec 1 min 	<p>Sets how long that the device waits, after its start button is pressed, before data is passed to the NVM.</p> <p>Note: The delay options are only available when the “Untethered datalog” has been selected on the Main Screen.</p>

Table 7. NVW Datalogger – Configuration screen (Continued)

Screen frame	Element	Description
Dynamic Range	<ul style="list-style-type: none"> • 2g • 4g • 8g 	Sets the range over which the accelerometer acquires data.

4.8 Directional Tap with FIFO application

The Directional Tap Application demo evaluates the built-in algorithm for detecting pulses in conjunction with the FIFO. You can evaluate Freescale's default configuration and modify those settings to tailor a demonstration for your target application.

This demo includes MCU-status and estimated-current displays, which enable you to demonstrate the device's power-saving sleep mode feature.

4.8.1 Active screen

The Active screen contains a set of indicators that change to green when a tap is detected. It also has a graph displaying the data stored in the FIFO, displays that show the MCU status, an estimate of used current, and the direction of the last tap.

Note: Before changing any of the Active screen's settings, select the Standby option button.

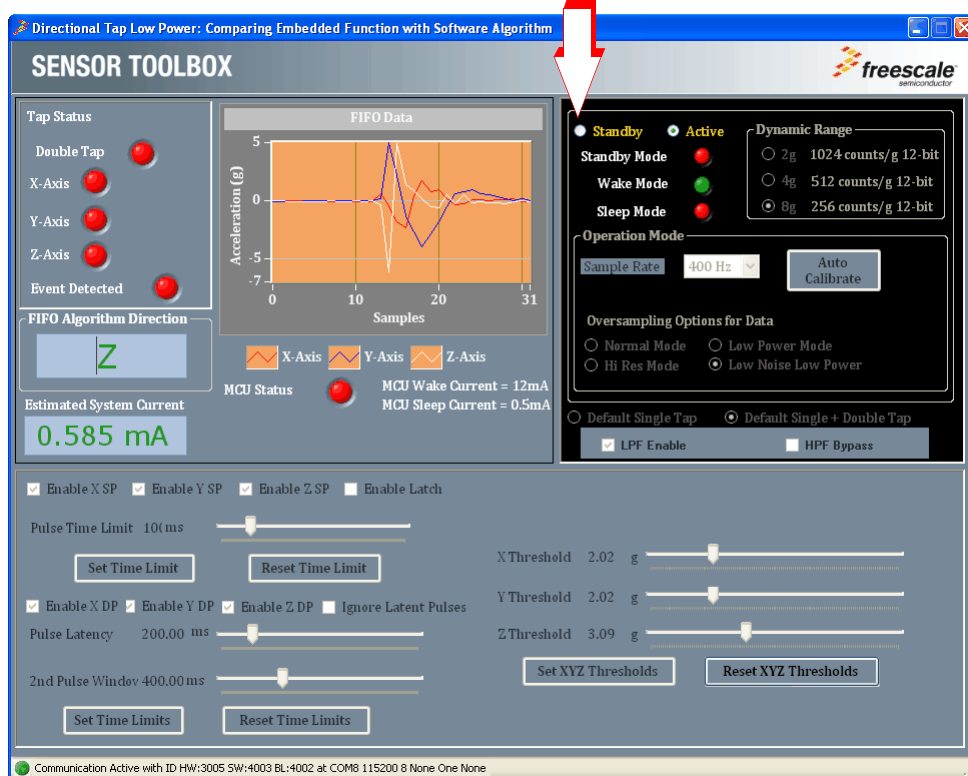

Table 8. Directional Tap – Active/Standby screens

Screen frame	Element	Description
Tap Status	Double Tap	Green indicates that a double tap has been detected.
	<ul style="list-style-type: none"> • X-Axis • Y-Axis • Z-Axis 	Green indicates the axis or axes along which the tap is occurring.
	Event Detected	Green indicates that a tap has been detected along any axis.
FIFO Algorithm Direction	Direction	Indicates the direction of the last tap the device detected. For example, “z-negative” indicates a tap on the top of the device.
FIFO Data	Acceleration Display	Shows the data collected and stored in the FIFO from the last tap.
MCU Status		Green indicates that the host MCU has been awakened from Sleep by event interrupts, and is active.
Estimated System Current		Displays the approximate amount of current that the device is drawing from the power source.

4.8.2 Standby screen

Use the Standby screen to:

- Set the Standby/Active mode
- Set the dynamic range
- Change the sample rate
- Set the over-sampling setting
- Change the orientation-detection parameters

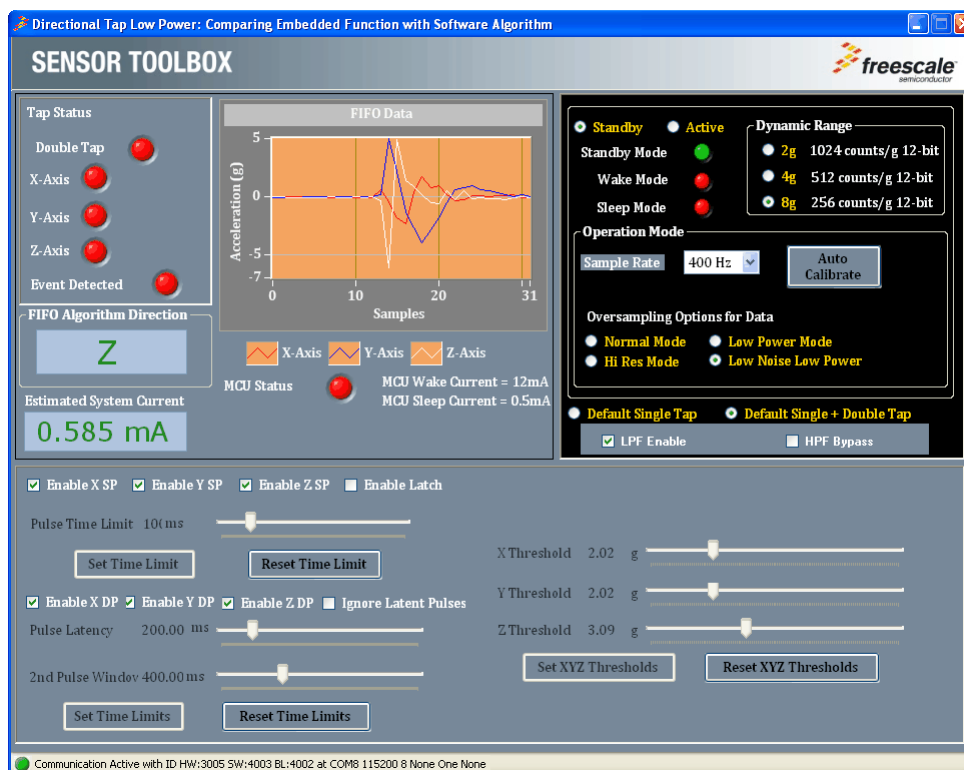

NOTE

Before changing any settings, enable Standby mode, because the settings cannot be changed in Active mode.

After changing any configuration settings, enable Active mode, to register the new settings with the device.

Table 9. Directional Tap – Active/Standby screens

Screen frame	Field or option	Description	
Operation Mode	Sample Rate	Enables you to change the rate at which the device acquires data.	
	Over-Sampling Options for Data	Normal Mode	Normal operation.
		Hi Res Mode	The device gives more accurate readings, but draws more current.
		Low Power Mode	The device draws less current than Normal mode does, but at the expense of accuracy.
		Low Noise Low Power	The device draws more current than Normal mode does, but less current than Low Power mode does, and reduces noise. Note: In Low Noise mode, any g-force greater than $\pm 4g$ will not be read.
Auto Calibrate	Directs the device to calculate the offsets for each axis (accounting for any error in measurements). For maximum resolution, the calibration is done with a dynamic range of 8g and a sample rate of 1.563 Hz. Note: Before enabling Auto Calibrate mode, place the device on a flat and stationary surface.		
Dynamic Range	<ul style="list-style-type: none"> • 2g • 4g • 8g 	Sets the range over which the accelerometer acquires data.	
Standby Active	Standby	Sets the device to Standby mode.	
	Active	Sets the device to Active mode.	
	<ul style="list-style-type: none"> • Standby Mode • Wake Mode • Sleep Mode 	Indicates the device's status. Note: The device will never enter Sleep mode during this demo.	
Tap choice: Choose Single or Single + Double tap	LPF Enable	LPF = Low-Pass Filter Sends accelerometer data through a low-pass filter before it is processed by the tap application. This filter treats higher frequency signals as noise, filtering out very fast shocks (to prevent them from being detected as taps).	
	HPF Bypass	HPF = High-Pass Filter Sends the raw accelerometer data to the tap application, bypassing the high-pass filter. <ul style="list-style-type: none"> • The HPF Bypass option button normally should be cleared. • Enabling the HPF Bypass can cause non-tap events (such as tilting the device) to be registered as taps. 	

Table 9. Directional Tap – Active/Standby screens (Continued)

Screen frame	Field or option	Description	
Tap configuration (both tap and double tap)	<ul style="list-style-type: none"> • X Threshold • Y Threshold • Z Threshold 	Sets the G threshold for a tap to be detected along the designated axis. Pulses with a G value less than the setting will be ignored. <ul style="list-style-type: none"> • Before using the sliders, you must click the Reset XYZ Thresholds button. • After using the sliders, click the Set XYZ Thresholds button. 	
	Set XYZ Thresholds	Note: Before changing the values of the X, Y, or Z threshold sliders, click Reset XYZ Thresholds. After changing the value of any of the axis threshold slider settings, click Set XYZ Thresholds.	
	Reset XYZ Thresholds		
	Enable Latch	Causes any triggered event to remain until the Status register is read. If this checkbox is not enabled, then the interrupt will only last as long as the event, and the Status register will represent the most-recent event. <ul style="list-style-type: none"> • The Enable Latch setting should be enabled for the tap detection to work properly. • If Enable Latch is disabled, then tap events will trigger multiple interrupts, instead of triggering a single interrupt. 	
	Set Time Limit	Sets the Pulse Time Limit.	Note: Before resetting the value of the Pulse Time Limit slider, click Reset Time Limit. After changing the value of the Pulse Time Limit slider, click Set Time Limit.
	Reset Time Limit	Resets the Pulse Time Limit.	
Tap configuration (single tap)	<ul style="list-style-type: none"> • Enable X SP • Enable Y SP • Enable Z SP 	(Enable Single Pulse) Allows flicks along these axes to trigger the “Event Detected” Indicator on the Demo Screen.	
	Pulse Time Limit	Sets the maximum time that a pulse can last before it (the pulse) is ignored as a non-tap event. <ul style="list-style-type: none"> • Before using the Pulse Time Limit slider, you must click the Reset Time Limits button. • After using the Pulse Time Limit slider, click the Set Time Limits button to change the setting. 	
	Default Single Tap	Sets the parameters for detecting single taps to the factory-defined values. To configure this frame’s other values, the Default Single Tap option button must be cleared.	
Tap configuration (double tap)	<ul style="list-style-type: none"> • Enable X DP • Enable Y DP • Enable Z DP 	(Enable Double Pulses) Enables detection of double pulses along the specified axis or axes. For example, if you only want to see double taps on the right side of the device, then clear the Z and Y DP checkboxes.	
	Pulse Latency	Sets the amount of time that the device waits after a pulse, before registering the next pulse. Subsequent pulses that occur within this period are ignored.	
	Second Pulse Latency	Sets the amount of time that the device will wait to reset, after receiving an initial pulse. A pulse detected after the set time will be considered a new first pulse.	
	Ignore Latent Pulses	Causes the device to ignore the Pulse Latency timer (set by the Pulse Latency Slider) and to detect taps directly after other taps.	
	Default Single + Double Tap	Sets the threshold for detecting single and double pulses to the factory-defined values. To configure this frame’s other values, the Default Single + Double Tap option button must be cleared.	

4.9 Directional Shake with FIFO application

The Directional Shake Application demo evaluates the built-in algorithm for detecting transient events in conjunction with the FIFO. You can evaluate Freescale's default configuration and modify those settings, to tailor a demonstration for your target application.

This demo includes MCU-status and estimated-current displays, which enable you to demonstrate the device's power-saving sleep mode feature.

4.9.1 Active screen

The Active screen contains a set of indicators that change to green when a transient event (shake) is detected. In the middle of the application window, a graph displays the data that is stored in the FIFO, triggered by the shake event.

- The detected shake directions are indicated by the left radio LEDs. Green means that the shakes are detected.
- The Software Algorithm field shows the last shake detected.
- The MCU state and estimate current are shown on the right.



Note: Before changing any of the Active screen's settings, select the Standby option button.

Table 10. Directional Shake – Active/Standby screens

	Element	Description
Shake (transient) Status	<ul style="list-style-type: none"> • X Negative • Y Negative • Z Negative 	Indicators change from red to green when a shake event is detected along the indicated axis.
	Event Detected	Indicator changes from red to green when a shake event is detected along any axis.
Software Direction	Direction	Displays the direction of the last shake that the device detected. For example, the display “z-negative” indicates the device was shaken downward.
FIFO Data	Acceleration Display	Shows the data collected and stored in the FIFO from the last shake.
MCU Status		Green indicates that the host MCU has been awakened from Sleep by event interrupts, and is active.
Estimated System Current		Displays the approximate amount of current that the device is drawing from the power source.

4.9.2 Standby screen

Use the Standby screen to to:

- Change the device to Standby/Active mode
- Set the dynamic range
- Change the sample rate of the device
- Change the over-sampling options
- Calibrate the device
- Change the parameters for detecting the transient events



NOTE

Before changing any settings, enable Standby mode, because the settings cannot be changed in Active mode.

After changing any configuration settings, enable Active mode, to register the new settings with the device.

Table 11. Directional Shake – Active/Standby screens

Screen frame	Field or option	Description	
Operation Mode	Sample Rate	Enables you to change the rate at which the device acquires data.	
	Over-Sampling Options for Data	Normal Mode	Normal operation.
		Hi Res Mode	The device gives more accurate readings, but draws more current.
		Low Power Mode	The device draws less current than Normal mode does, but at the expense of accuracy.
		Low Noise Low Power	The device draws more current than Normal mode does, but less current than Low Power mode does, and reduces noise. Note: In Low Noise mode, any g-force greater than $\pm 4g$ will not be read.
Auto Calibrate	Directs the device to calculate the offsets for each axis (accounting for any error in measurements). For maximum resolution, the calibration is done with a dynamic range of 8g and a sample rate of 1.563 Hz. Note: Before enabling Auto Calibrate mode, place the device on a flat and stationary surface.		
Dynamic Range	<ul style="list-style-type: none"> • 2g • 4g • 8g 	Sets the range over which the accelerometer acquires data.	
Standby Active	Standby	Sets the device to Standby mode.	
	Active	Sets the device to Active mode.	
	<ul style="list-style-type: none"> • Standby Mode • Wake Mode • Sleep Mode 	Indicates the device's status. Note: The device will never enter Sleep mode during this demo.	

Table 11. Directional Shake – Active/Standby screens (Continued)

Screen frame	Field or option	Description
Transient Settings	Default Transient Settings	Returns the demo parameters for detecting shakes to the default settings (configured at the factory).
	Bypass HPF	HPF = High-Pass Filter Sends the raw accelerometer data to the shake application, bypassing the high-pass filter. <ul style="list-style-type: none"> • Normally, the Bypass HPF option button should be cleared. • Enabling the Bypass HPF can cause non-shake events (such as tilting the device) to be registered as shakes.
	Threshold	Sets the threshold for flick events to be detected. Flicks at a smaller g-force than this value are filtered out. <ul style="list-style-type: none"> • Before using the Threshold slider, you must first click the Reset button. • After using the Threshold slider, click the Set button to change the setting.
	Debounce	Sets the amount of time that the configured conditions must be in place to trigger the main flick event. Any event whose duration does not exceed this time will not trigger an interrupt. <ul style="list-style-type: none"> • Before using the Debounce slider, you must first click the Reset button. • After using the Debounce slider, click the Set button to change the setting.
	<ul style="list-style-type: none"> • Enable X SP • Enable Y SP • Enable Z SP 	(Enable Single Pulse) Allows flicks along these axes to trigger the “Event Detected” Indicator on the Demo Screen. Note: Only the Y axis will move the pictures and correctly trigger the direction indicator. If enabled, the X and Z axes will trigger only the Event Detected indicator on the Demo screen.
	Enable Latch	Causes any triggered event to remain until the Status register is read. If the Enable Latch checkbox is not enabled, then: <ul style="list-style-type: none"> • the interrupt will only last as long as the event • the Status register will represent the most-recent event
	Decrement Debounce	Select to decrement the Debounce timer each time that an event fails to reach the debounce time.
	Clear Debounce	Select to reset the timer set by the Debounce slider each time that an event fails to reach the debounce time.
	Set	Saves the new configuration of the Threshold and Debounce sliders. After changing the values of the Threshold and Debounce sliders, click Set to implement the settings.
	Reset	Enables a new configuration of the Threshold and Debounce sliders. Before changing the settings of the Threshold and Debounce sliders, click Reset.

4.10 Full-System Evaluation application

The Full-System Evaluation application enables you to access all of the features of the device from a single screen. You can evaluate Freescale’s default configuration for all device features, and modify feature settings to tailor a demonstration for your target application.

4.10.1 Operation-Mode frame

An Operation-Mode frame appears at the top of each screen, with tabs below that frame, enabling you to quickly navigate among the different demos.

Note: Before changing any of the Operation-Mode frame settings, select the Standby option button.

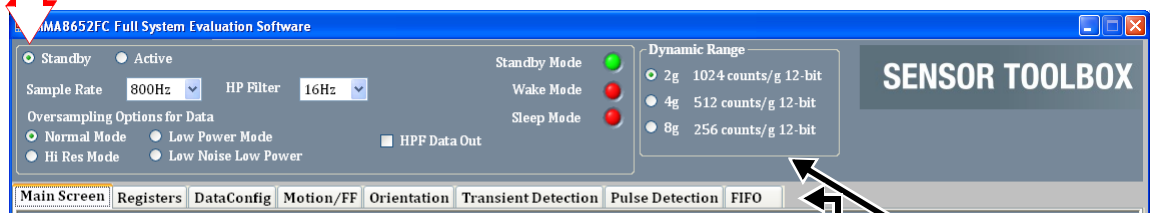

NOTE

Before changing any settings, enable Standby mode, because the settings cannot be changed in Active mode.

After changing any configuration settings, enable Active mode, to register the new settings with the device.

Table 12. Full-System Evaluation – Operation-Mode screen

Screen frame	Field or option	Description		
Main	Standby	Sets the device to Standby mode. Note: Standby mode is not the same as Sleep mode.		
	Active	Sets the device to Active mode, enabling data to be collected.		
	Sample Rate	Enables you to change the rate at which the device acquires data.		
	HP Filter	Sets the cut-off frequency for the high-pass filter that data is processed with, before it (the data) is displayed on a demo screen. The HP filter is enabled by the HPF Data Out checkbox.		
	<ul style="list-style-type: none"> • Standby Mode • Wake Mode • Sleep Mode 	Indicates the device's status (Read only).		
	Over-Sampling Options for Data	Normal Mode	Normal operation.	
		Hi Res Mode	The device gives more accurate readings, but draws more current.	
		Low Power Mode	The device draws less current than Normal mode does, but at the expense of accuracy.	
		Low Noise Low Power	The device draws more current than Normal mode does, but less current than Low Power mode does, and reduces noise.	
	HPF Data Out	HPF = High-Pass Filter Causes data to be processed by the device's high-pass filter, before that data is used by the application for the graphical or other display.		
Enable Low Noise	Enables the device's Low Noise Mode for more accurate readings. Note: In Enable Low Noise mode, any g-force greater than $\pm 4g$ will not be read.			
Dynamic Range	<ul style="list-style-type: none"> • 2g • 4g • 8g 	Sets the range over which the accelerometer acquires data.		

4.10.2 Main screen

The Main screen contains the following frame groups:

- Real-Time Output
- Sleep Mode Over-Sampling Options
- System Interrupt Settings

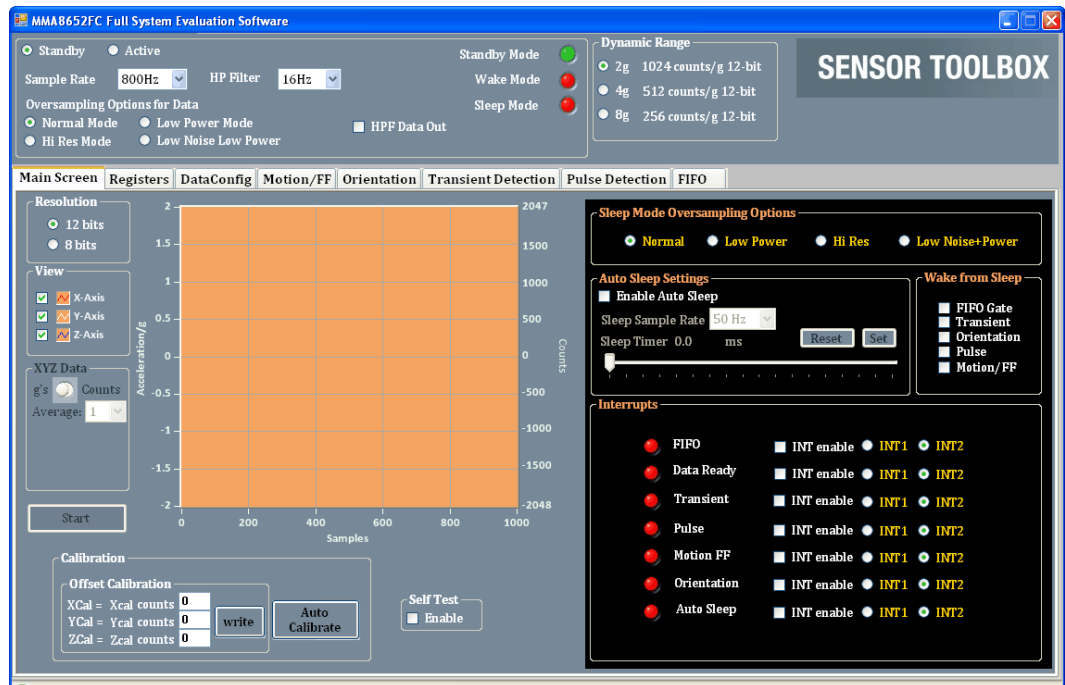

Table 13. Full-System Evaluation – Main screen

Screen Frame	Element or screen group	Element or description	Description
			<ul style="list-style-type: none"> • To display data in the Real-Time Output frame, the View button must be clicked. • To stop displaying the current readings, click the Disable button.
Real-Time Output	Acceleration Graph		Shows the data collected and stored in the FIFO from the last shake. The acceleration in Gs is plotted against the number of samples.
	XYZ 12-Bit XYZ 8-Bit		Selects the number of bits to be read from the device. A higher number of bits produces more precise values, but requires more time and power. <ul style="list-style-type: none"> • Selecting the 8-bit option causes the program to read only the 8 bits stored in the X, Y, and Z MSB registers. • Selecting 10 bits for the MMA8653FC reads the 8 MSB bits and the 2 bits stored in the X, Y, and Z LSB registers. • Selecting 12 bits for the MMA8652FC reads the 8 MSB bits and the 4 bits stored in the X, Y, and Z LSB registers.
	View		Check the check box in front of the axis to display the corresponding axis data in the graph.
	XYZ data		Directs the device to display the readings in g's (or counts) for the selected axis or axes.
	Start / Stop		Click Start button to start the display of accelerometer data on graph. Click Stop to stop displaying data. Note: Ensure that the device is in Active mode for valid data output.

Table 13. Full-System Evaluation – Main screen (Continued)

Screen Frame	Element or screen group	Element or description	Description
Real-Time Output (continued)	Offset Calibration	<ul style="list-style-type: none"> • XCal Counts • YCal Counts • ZCal Counts 	<p>Specifies the values to be added to the device's output measurements, to correct for any data inaccuracies.</p> <p>The calibration values will need to be calculated differently, varying with the Dynamic Range setting. If the device is reading 21 counts in the X-axis when sitting flat on a table (should be 0 counts), then the following correct values are required for the indicated Dynamic Range setting:</p> <ul style="list-style-type: none"> • 2g – Divide the count by 4 before storing it in the register. It is not possible to store fractional values, so in this case $2\frac{1}{4} = 5.25$, and you must round down and put -5 in the XCal field. • 4g – you must divide the number by 2, before storing it in the register. In the above situation, you would place ($2\frac{1}{2} = 10.5$) either -10 or -11 in the XCal field. • 8g – No correction is required.
		Write	Writes the values in the XCal, YCal, and ZCal text boxes into the calibration register.
	Auto Calibrate	<p>Makes the device calculate the necessary values for the X, Y, and ZCal fields. The calibration is done with an 8g Dynamic Range and a Sample Rate of 1.563 Hz.</p> <p>Before clicking the Auto Calibrate button:</p> <ul style="list-style-type: none"> • Place the device on a flat, stationary surface. • Enable the Standby button (in the Operation Mode screen). 	
Self Test	Enable Button	<p>Initiates a test where the device applies a small electrostatic force to the sensor, to simulate a small acceleration.</p> <p>If you leave this box checked during tests, then all measurements will be offset by this simulated acceleration.</p>	

Table 13. Full-System Evaluation – Main screen (Continued)

Screen Frame	Element or screen group	Element or description	Description
Sleep Mode Over-Sampling Options	<ul style="list-style-type: none"> • Normal Mode • Hi Res Mode • Low Power Mode • Low Noise Low Power 	<p>Selects the over-sampling options to be used when the device is in Sleep Mode:</p> <ul style="list-style-type: none"> • Normal — Implements normal operation. • Hi Res — Collects more accurate readings, but draws more current. • Low Power — Draws less current than Normal mode does, but at the expense of accuracy. • Low Noise Low Power — Draws more current than Normal mode does, but less current than Low Power mode does, and reduces noise. 	
	Auto Sleep Settings	Enable Auto Sleep	Enables the Auto-Sleep function of the device, which puts the device in Sleep mode when no actions are taken for the duration of the sleep timer.
	<ul style="list-style-type: none"> • Before changing any setting in the Auto Sleep Settings screen group, click Reset. • After the settings are changed, click Set. 	Sleep Sample Rate	Sets the sample rate for the device when it is in Sleep mode. Lower sample rates will use less power while the device is sleeping.
		Sleep Timer Slider	Determines how long a period of inactivity must pass before the device enters Sleep mode.
		Reset	Before changing any setting in the Auto Sleep Settings screen group, click Reset to enable using a new configuration.
Set	After changing any settings in the Auto Sleep Settings screen group, click Set to ensure that all of the settings are registered with the device.		
Wake from Sleep	<ul style="list-style-type: none"> • FIFO Gate • Transient • Orientation • Pulse • Motion/FF 	<p>Specifies what type of event wakes the device from Sleep Mode.</p> <p>For example, if the Pulse box is checked, then tapping the device will wake it from sleep.</p> <p>Note: An application cannot wake the device from sleep (even if selected in this box) unless:</p> <ul style="list-style-type: none"> • the application is configured in its own screen (in the case of a Pulse, the Pulse Detection screen), • and the application's interrupt is enabled in the Interrupts section of the Main Screen. 	
System Interrupt Settings	Interrupt	This device has 7 interrupt sources: FIFO, Data Ready, Transient, Pulse, Motion FF, Orientation, Auto Sleep.	

4.10.3 Registers screen

The Registers screen enables you to read from or write to any of the device’s registers. For information about the functions and values of each register, see the MMA8652FC / MMA8653FC data sheets.

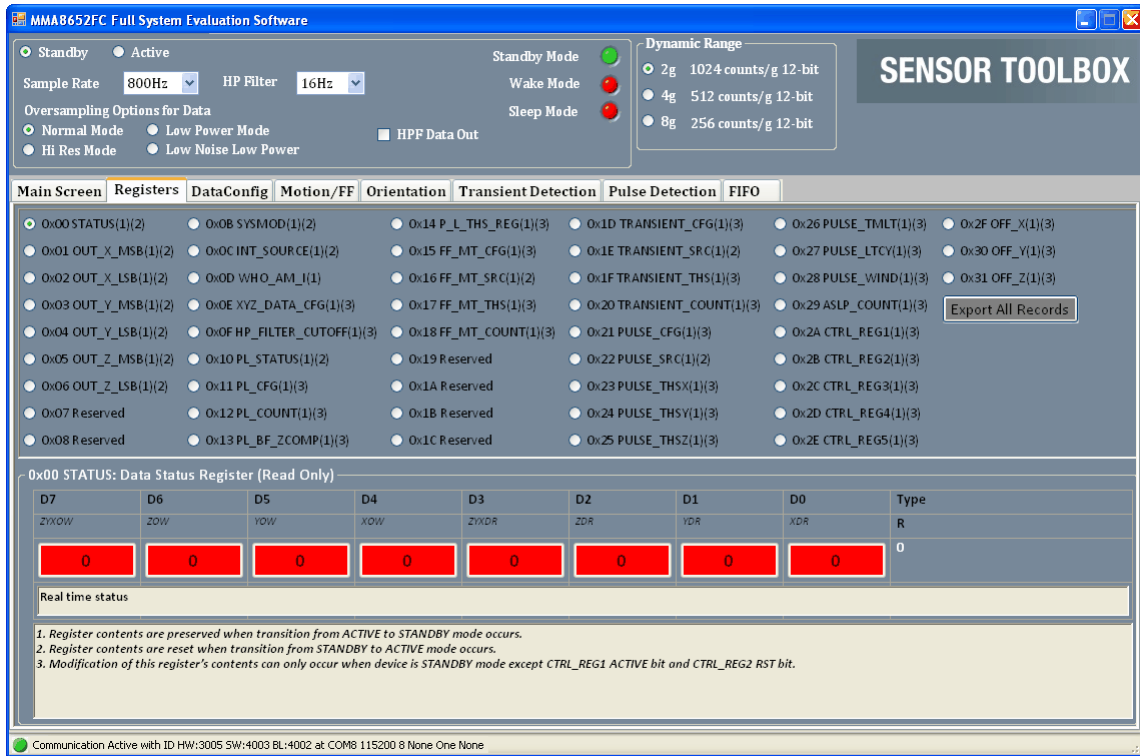

4.10.4 DataConfig screen

The Data Configuration and Interrupt Configuration Settings (DataConfig) screen enables you to:

- Set the operation mode for the interrupt pins
- Observe the Data Register (0x00) for Data ready status or FIFO status (when the FIFO is enabled)

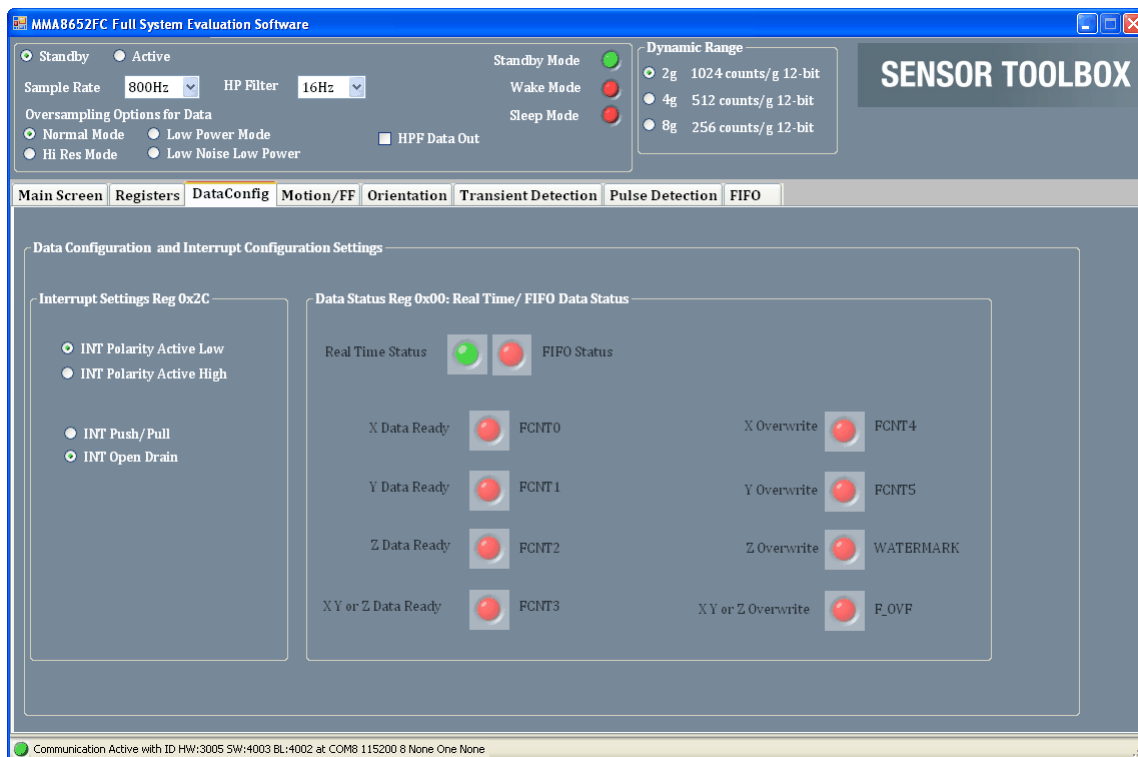

Table 14. Full-System Evaluation – DataConfig screen

Screen frame	Element	Description
Interrupt Settings (Reg 0x2C)	<ul style="list-style-type: none"> • INT Polarity Active Low • INT Polarity Active High 	<ul style="list-style-type: none"> • Active Low —the interrupt pins to sit at a logical high level (1), and to go to logical low (0) when they are triggered. • Active High —the interrupt pins to sit at a logical low level (0), and to go to logical high (1) when they are triggered.
	<ul style="list-style-type: none"> • INT Push/Pull • INT Open Drain 	<ul style="list-style-type: none"> • Push/Pull — Activates two transistors on the interrupt pins that push up or pull down the output to the desired level. <i>This is the default setting.</i> • Open Drain— When selected, the interrupt pins will be open drain, which allows multiple interrupt signals to be connected to the same interrupt line.

Table 14. Full-System Evaluation – DataConfig screen (Continued)

Screen frame	Element	Description
Data Status Reg 0x00: Real Time/FIFO Data Status	<ul style="list-style-type: none"> • Real-Time Status • FIFO Status 	<ul style="list-style-type: none"> • Real-Time Status — Indicator goes from red to green when the data is read (bit reads 1 when FIFO is disabled). • FIFO Status — Indicator goes from red to green when the data is read (bit reads 1 when FIFO is enabled).
	<ul style="list-style-type: none"> • X Data Ready (FCNT0) • Y Data Ready (FCNT1) • Z Data Ready (FCNT2) 	These indicators shift from red to green when a new measurement is waiting to be read in the output register for the respective axis or axes.
	X, Y, or Z Data Ready (FCNT3)	Shifts from red to green if <i>any axis</i> has a new reading waiting to be read. If there is no data, then the indicator remains red.
	<ul style="list-style-type: none"> • X Overwrite (FCNT4) • Overwrite (FCNT5) • Overwrite (Watermark) 	These indicators shift from red to green if a new measurement has replaced a measurement (that previously triggered the Data Ready indicator) before that earlier measurement was read.
	X, Y, or Z Overwrite (F_OVF)	Shifts from red to green if <i>any axis</i> had an old measurement that was replaced by a new measurement before the earlier measurement was read.

4.10.5 Motion/Freefall (M/FF) screen

This screen enables you to configure the motion detection and the freefall detection applications in the left section. The detection result is shown at the left bottom section. The accelerometer axes data can be selected to plot on the right graph.

The screenshot shows the 'MMA8652FC Full System Evaluation Software' interface. The 'Motion/FF' tab is selected. The interface is divided into several sections:

- Top Left:** Control buttons for Standby (Active), Sample Rate (800Hz), HP Filter (16Hz), and Oversampling Options (Normal, Hi Res, Low Power, Low Noise Low Power).
- Top Right:** Dynamic Range selection (2g, 4g, 8g) and status indicators for Standby Mode, Wake Mode, and Sleep Mode.
- Middle:** Navigation tabs for Main Screen, Registers, DataConfig, Motion/FF, Orientation, Transient Detection, Pulse Detection, and FIFO.
- Left Panel (Motion Freefall):**
 - Default Motion Settings and Default Freefall Settings.
 - Logic selection: OR (selected) or AND.
 - Axis enablement: Enable X-Axis, Enable Y-Axis, Enable Z-Axis.
 - Enable Latch checkbox.
 - Threshold 0 slider (g).
 - Debounce 0.00 slider (ms).
 - Buttons: Set, Reset, Decrement Debounce, Clear Debounce.
 - Motion OR FF and Event Detected status indicators.
 - Motion Status section with Axis of Event (X, Y, Z) and Direction (X, Y, Z) indicators.
- Right Panel (Real Time Output):**
 - Graph showing Acceleration in g's vs Samples (0 to 10).
 - Legend: Motion/FF X Axis, Motion/FF Y Axis, Motion/FF Z Axis.
- Bottom:** Communication status: Communication Active with ID HW:3005 SW:4003 BL:4002 at COM8 115200 8 None One None.

Table 15. Full-System Evaluation – Motion/FF screen

Screen frame	Element or frame group	Element	Description
Motion Freefall Note: To configure a value in the Motion Freefall frame, both the Default Motion Settings and Default Freefall Settings checkboxes must first be cleared.	Default Motion Settings		Sets the parameters for detecting general motion to the factory default values.
	Default Freefall Settings		Sets the parameters for detecting freefall to the factory default values.
	<ul style="list-style-type: none"> • OR • AND 		Any event meeting this criteria is run through the configured OR or AND setting, to determine if the event is displayed. <ul style="list-style-type: none"> • OR — Directs the event on the selected axes to be run through a logical OR. • AND — Directs the events on the selected axes to be run through a logical AND. This will trigger an event only if all of the checked events occur. Note: In order to select OR or AND, both the Default Motion Settings and Default Freefall Settings checkboxes must be cleared.
	<ul style="list-style-type: none"> • Enable X-Axis • Enable Y-Axis • Enable Z-Axis 		Directs the device to monitor for an event along the specified axis or axes, at a g force with an absolute value higher than that specified by the Threshold slider.
	Enable Latch		Causes any interrupt triggered by an event to remain until the Status register is read. If the Enable Latch checkbox is not enabled, then the interrupt will last only as long as the event does, and the Status register represents the most-recent event.
	Threshold		Sets the threshold for events to be detected. Events at a smaller g-force than this value are filtered out. <ul style="list-style-type: none"> • Before using the Threshold slider, click Reset. • After using the Threshold slider, click Set to change the setting.
	Debounce		Sets the amount of time that the configured conditions must be in place to trigger an interrupt. Any event whose duration does not exceed this time will not trigger an interrupt. <ul style="list-style-type: none"> • Before using the Debounce slider, click Reset. • After using the Debounce slider, click Set to change the setting.
	Set		Saves the new configuration settings after the repositioning of the Threshold and Debounce sliders. After changing either the Threshold or Debounce slider, click Set to register the new settings with the device.
	Reset		Resets the Threshold and Debounce sliders. Before configuring the Threshold or Debounce sliders, click Reset to enable the new configuration.
	Decrement Debounce		Causes the Debounce timer to be decremented, for each time that an event fails to reach the debounce time.
	Clear Debounce		Causes the timer set by the Debounce slider to reset to 0, for each time that an event fails to reach the debounce time.
Motion or FF Event Detected		This indicator switches from red to green if an event is triggered.	

Table 15. Full-System Evaluation – Motion/FF screen (Continued)

Screen frame	Element or frame group	Element	Description
Motion Freefall (continued)	Motion Status	Axis of Event	The indicator(s) switch from red to green when an event is triggered along the specified axis or axes: <ul style="list-style-type: none"> • X-Axis • Y-Axis • Z-Axis
		Direction	Displays the direction(s) of the event: <ul style="list-style-type: none"> • X-Direction • Y-Direction • Z-Direction For example, the display “z-negative” indicates the device was shaken downward.
LPF / HPF Data Plot	This frame's label displays Low-Pass Filter Data Out or High-Pass Filter Data Out depending on whether the HP Filter option button has been enabled on the Full-System Evaluation demo's Operation Mode screen.		
	Real-Time Output	<ul style="list-style-type: none"> • X-Axis • Y-Axis • Z-Axis 	Each checkbox enables the collection of data along the selected axis or axes.
		(Graph)	Displays the data acquired by the accelerometer. Acceleration in Gs is plotted against the number of samples.
		<ul style="list-style-type: none"> • X-Axis • Y-Axis • Z-Axis 	These graph-legend entries give the line color of the graph lines for the respective axes.

4.10.6 Orientation screen

This screen enables you to configure the orientation detection applications in the left section. The detection result is shown at the right section.

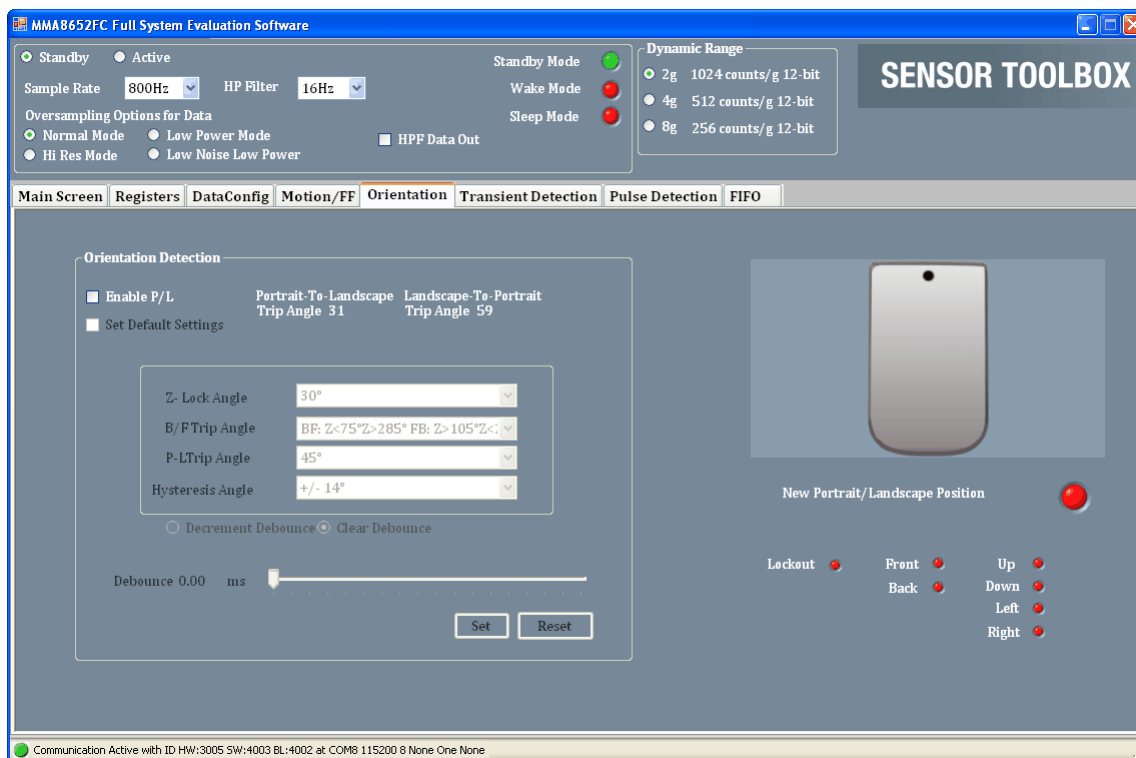

Table 16. Full-System Evaluation – Orientation screen

Screen Frame	Element	Description
Orientation Detection Setting Note: Before changing settings in the Orientation Detection frame, the Enable P/L checkbox must be enabled.	Enable P/L	Enables configuration of the other parameters in the frame. (Clearing this checkbox will not, however, prevent the demo from functioning.)
	Portrait-to-Landscape Trip Angle	Shows the current value. (Read only)
	Landscape-to-Portrait Trip Angle	Shows the current value. (Read only)
	Set Default Settings	Restores all portrait-to-landscape orientation settings to the factory default values.
	Z-Lock Angle	Sets the Z-axis angle at or below which the device will ignore changes in orientation, because that value is considered to be the flat orientation.
	B/F Trip Angle	(Back/Front Trip Angle) Sets the range of z-axis angles that the device considers as facing front and back.
	P-L Trip Angle	(Portrait to Landscape) Sets the <i>midpoint</i> of the angle at which the device changes from portrait to landscape orientation. The P-L Trip Angle is measured down from the x axis (for changing to the right landscape orientation), and up from the x axis (for changing to left landscape orientation).
	Hysteresis Angle	Sets the <i>distance from the midpoint</i> of the angle at which the device changes from portrait to landscape orientation. The actual trip angle for changing orientation is the P-L Angle \pm this angle.
	Decrement Debounce	Causes the Debounce timer to be decremented, for each time that an event fails to reach the debounce time.
	Clear Debounce	Causes the timer set by the Debounce slider to reset, for each time that an event fails to reach the debounce time.
	Debounce slider	Sets the amount of time that the configured conditions must be in place, in order to trigger an interrupt. Any event whose duration does not exceed this time do not trigger an interrupt. <ul style="list-style-type: none"> • Before moving the Debounce slider, the Enable P/L checkbox must be enabled and the Reset button must be clicked. • After moving the Debounce slider, click the Set button to change the setting.
	Set	Saves the new configuration settings after the repositioning of the Debounce slider. After changing either the Debounce slider, click Set to register the new settings with the device.
Reset	Resets the Debounce slider. Before configuring the Debounce slider, click Reset to enable the new configuration.	

Table 16. Full-System Evaluation – Orientation screen (Continued)

Screen Frame	Element	Description
Orientation Detection Indicator (Read only)	New Portrait/Landscape Position	Indicator switches from red to green when there is an orientation change.
	Lockout	Indicator switches from red to green, to display which parameter (of the configured orientation parameters) has been tripped.
	<ul style="list-style-type: none"> • Front • Back 	
	<ul style="list-style-type: none"> • Up • Down • Left • Right 	

4.10.7 Transient (Shake) Detection screen

This screen enables you to configure the transient detection applications in the left section. The detection result is shown at the left bottom part. The accelerometer axes data can be selected to plot on the right graph.

Note: For best results in detecting transient events, the HPF Data Out box in the Operation-Mode Frame should be checked.

The screenshot shows the 'MMA8652FC Full System Evaluation Software' interface. The 'Transient Detection' tab is selected. In the top right, the 'HPF Data Out' checkbox is highlighted with a red arrow and a note. The 'Transient Settings' section includes options for 'Default Transient Settings', 'Bypass HPP', and flags for X, Y, and Z axes. The 'Threshold' is set to 0 g and 'Debounce' is 0.00 ms. The 'Real Time Output' graph shows acceleration in g's on the y-axis (ranging from -8 to 8) and 'Samples' on the x-axis (ranging from 0 to 10). The graph area is currently blank, indicating no transient event has been detected yet. The status section at the bottom left shows 'Event Detected' with a red indicator light.

The elements of this shake-detection screen are described in the following table.

Table 17. Full-System Evaluation – Transient Detection screen

Screen frame	Element	Description
Transient Detection Settings Note: Before configuring the settings, the Default Transient settings checkbox must be unchecked.	Default Transient Settings	Restores all transient-detection settings to the factory default values.
	Bypass HPF	HPF = High-Pass Filter Directs the application to use the raw accelerometer data before it (the raw data) has been passed through the HPF. The Bypass HPF setting should normally be disabled.
	<ul style="list-style-type: none"> • Enable X Flag • Enable Y Flag • Enable Z Flag 	Allows shakes along these axes to trigger the “Event Detected” Indicator on the Demo Screen.
	Enable Latch	Causes any triggered event to remain until the Status register is read. If the Enable Latch checkbox is not enabled, then the interrupt will only last as long as the event, and the Status register will represent the most-recent event.
	Threshold slider	Sets the threshold for the minimum g force required for a shake event to be detected. Shakes at a smaller g-force than this value are filtered out. <ul style="list-style-type: none"> • To move the Threshold slider, the Reset button must be clicked. • After moving the Threshold slider, click the Set button to change the setting.
	Debounce slider	Sets the minimum time that a shake must last, for a shake event to be detected.
	Set	After changing the Debounce slider, click Set to register the new settings with the device.
	Reset	Before configuring the Debounce slider, click Reset to enable the new configuration.
	Decrement Debounce	Causes the Debounce timer to be decremented, for each time that an event fails to reach the debounce time.
Clear Debounce	Causes the timer set by the Debounce slider to reset, for each time that an event fails to reach the debounce time.	
Transient Detection Indicator (Read only)	<ul style="list-style-type: none"> • X Direction X • Y Direction Y • Z Direction Z 	The indicator(s) switch from red to green when an event is detected along the specified axis or axes.
	Event Detected	This indicator switches from red to green if a transient event is detected.
LPF / HPF Data Plot	This frame's label displays Low-Pass Filter Data Out or High-Pass Filter Data Out, depending on whether the HP Filter option button has been enabled on the Full-System Evaluation demo's Operation Mode screen.	
	<ul style="list-style-type: none"> • X-Axis • Y-Axis • Z-Axis 	Each checkbox enables the collection of data along the selected axis or axes.
	(Graph)	Displays the data acquired by the accelerometer.
	<ul style="list-style-type: none"> • X-Axis • Y-Axis • Z-Axis 	These graph-legend entries give the line color for the respective axes. (Read only)

4.10.8 Pulse Detection screen

This screen enables you to configure the pulse detection applications in the left section. The detection result is shown at the right section.

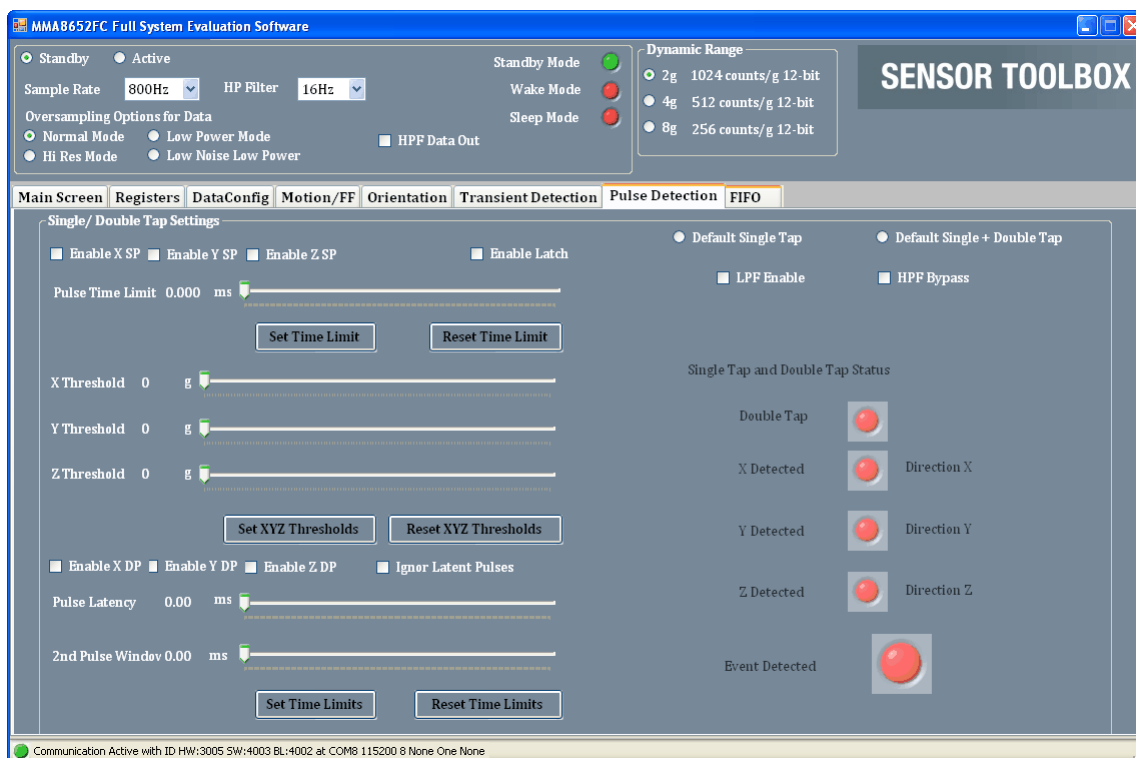

NOTE

Before changing any settings, enable Standby mode, because the settings cannot be changed in Active mode.

After changing any configuration settings, enable Active mode, to register the new settings with the device.

Table 18. Full-System Evaluation – Pulse Detection screen

Screen frame	Field or option	Description	
Overall settings	Default Single Tap	Sets the parameters for detecting single taps to the factory-defined values.	
	Default Single + Double Tap	Sets the threshold for detecting single and double taps to the factory-defined values.	
	LPF Enable	<p>LPF = Low-Pass Filter</p> <p>Sends accelerometer data through a low-pass filter before it (the data) is processed by the tap application.</p> <p>The low-pass filter treats higher frequency signals as noise, filtering out very fast shocks, to prevent them (the fast shocks) from being detected as taps.</p>	
	HPF Bypass	<p>HPF = High-Pass Filter</p> <p>Sends the raw accelerometer data to the tap application, bypassing the high-pass filter.</p> <ul style="list-style-type: none"> • The HPF Bypass option button normally should be cleared. • Disabling the high pass filter can cause non-tap events (such as tilting the device) to be registered as taps. 	
Single Tap Settings	<ul style="list-style-type: none"> • Enable X SP • Enable Y SP • Enable Z SP 	<p>(Enable Single Pulse)</p> <p>Allows taps along these axes to trigger the “Event Detected” Indicator on the Tap Status frame.</p> <p>For example, to see only taps on the top of the device, clear the X and Y SP boxes.</p>	
	Enable Latch	<p>Causes any triggered event to remain until the Status register is read.</p> <p>If the Enable Latch checkbox is not enabled, then the interrupt will only last as long as the event, and the Status register will represent the most-recent event.</p>	
	Pulse Time Limit slider	Sets the maximum time that a tap can last before it is ignored (i.e., it is not considered a tap).	
	Set Time Limit	Click Set to register the new settings with the device.	<ul style="list-style-type: none"> • Before changing the Pulse Time Limit slider, click Reset Time Limit. • After changing the Pulse Time Limit slider click Set Time Limit.
	Reset Time Limit	Click Reset to enable a new configuration.	
	<ul style="list-style-type: none"> • X Threshold • Y Threshold • Z Threshold sliders 	<p>Sets the g threshold for a tap to be detected along the designated axis.</p> <p>Pulses with a G value less than the setting will be ignored.</p>	<ul style="list-style-type: none"> • Before using the axis threshold sliders, click Reset XYZ Thresholds. • After using the axis threshold sliders, click Set XYZ Thresholds.
	Set XYZ Thresholds	Click Set to register the new settings with the device.	
Reset XYZ Thresholds	Click Reset to enable a new configuration.		

Table 18. Full-System Evaluation – Pulse Detection screen (Continued)

Screen frame	Field or option	Description
Double Tap Settings	<ul style="list-style-type: none"> • Enable X DP • Enable Y DP • Enable Z DP 	<p>DP = Double Pulses</p> <p>Enables detection of double pulses along the specified axis or axes. For example, if you only want to see double taps on the X axis of the device, then the Y and Z DP checkboxes should be cleared.</p>
	Ignore Latent Pulses	Causes the device to ignore the Pulse Latency timer (set by the Pulse Latency Slider) and detect taps directly after other taps.
	Pulse Latency slider	<ul style="list-style-type: none"> • Before using the Pulse or Second Pulse Latency slider, click Reset Time Limits. • After using the Pulse or Second Pulse Latency slider, click Set Time Limits to change the setting.
	Second Pulse Latency slider	
	Set Time Limits	Click Set to register the new settings with the device.
	Reset Time Limits	Click Reset to enable a new configuration.
Single Tap and Double Tap Detection Indicator (Read only)	Double Tap	The indicator turns green to indicate that a double tap has been detected.
	<ul style="list-style-type: none"> • X Detected - Direction X • Y Detected - Direction Y • Z Detected - Direction Z 	The indicator(s) switch from red to green when a tap / double tap event is detected along the specified axis or axes.
	Event Detected	The indicator switches from red to green if a tap / double tap is detected.

4.10.9 FIFO screen (MMA8652 only)

This screen enables you to configure the FIFO feature of the MMA865xFC device.

- The FIFO configuration is in the top left section.
- The FIFO events and status indicators are located at the left bottom part of the screen.
- The FIFO data is displayed on the right section. This data can be copied to the clipboard desired.



NOTE

Before changing any settings, enable Standby mode, because the settings cannot be changed in Active mode.

After changing any configuration settings, enable Active mode, to register the new settings with the device.

Table 19. Full-System Evaluation – FIFO screen

Screen frame	Field or option	Description
FIFO mode configuration	Disabled option button	Disables the FIFO.
	Fill Buffer option button	Enable the FIFO and choose Fill mode. Fills the FIFO with data, dumps that data to the text field on the right, and begins filling the FIFO again.
	Circular Buffer option button	Enable the FIFO and choose Circular mode. Fills the FIFO with data until it is full, and then begins overwriting the oldest data, each time that new data is received.
	Trigger Mode option button	Enable the FIFO and choose Trigger mode. Collects data in the Circular mode up to the watermark. When the trigger event occurs, the device fills the rest of the FIFO with data, and then stops taking data. (The trigger source is listed under Trigger source.)
	Set Watermark	Click Set Watermark to register the new settings with the device.
	Reset Watermark	Click Reset Watermark to enable a new configuration.
	Watermark slider	Sets the FIFO count after which the Watermark Flag activates.
	Trigger source • Trigger Transient • Tripper LP • Trigger Tap • Trigger MFF	When the Trigger Mode option button is selected, choose one of these trigger sources to trigger the FIFO to store accelerometer data: • Transient (shake) • LP (landscape/portrait) • Tap • MFF (Motion/Freefall)
FIFO status indicator (Read only)	Trigger event indicator • Transient • LP • Tap • MFF	The indicators switch from red to green to indicate that the following events have been detected: • Transient (shake) • LP (landscape/portrait) • Tap • MFF (Motion/Freefall)
	Current FIFO Count	Displays the number of samples currently stored in the FIFO.
	Overflow Flag	The indicator switches from red to green to indicate that the FIFO has begun overwriting data in the Circular Buffer mode.
	Watermark Flag	The indicator switches from red to green to indicate that a watermark event has occurred.
FIFO data	• View 8-Bit Data • View 12-Bit Data	Specifies the bit resolution to be used when reading data from the FIFO and displayed in the text field. A higher bit count produces more-precise values, but requires more time and power. • 8-Bit — Dumps only the 8 bits stored in the X, Y, and Z MSB registers • 12-Bit — Dumps the 8 MSB bits and the 4 bits stored in the X, Y, and Z LSB registers.
	Data Display textbox	Displays data dumped from the FIFO.
	Clear	Clear the FIFO data from the textbox.
	Copy to clipboard	Copy all the FIFO data that has been running under the current configuration to the clipboard. You can access this data by copying them to an Excel spreadsheet.

5 Running the Accelerometer Demonstrations

This section gives examples of how the demonstrations can be used. For details about each demonstration, see [Section 4, “Understanding the Accelerometer Demonstrations”](#).

5.1 Directional Flick application

1. Launch the sensor toolbox software with the MMA865xFC accelerometer connected to the evaluation board.
2. From the Demo Launch menu, select the Directional Flick Low-Power with FIFO demonstration button.
3. Hold the device as indicated in the screen’s picture.
4. Flick the device to the right.

The pictures to the right should scroll in the direction of flick.

Also see [“Directional Flick application” on page 10](#).

5.2 Orientation (Portrait/Landscape) application

1. Launch the sensor toolbox software with the MMA865xFC accelerometers connected to the evaluation board.
2. Select the Orientation Detection demonstration from the main launcher menu.
3. Hold the device flat with the USB connection on the *right*.
4. Rotate the device clockwise, so that the USB connector is pointing down.
 - The Portrait/Landscape gauge on the left should read “Right.”
 - The phone displayed in the middle should be facing you while laying on its side with the buttons on the left.
 - The Front/Back gauge should read “Front.”

The device can be placed in any orientation to demonstrate its ability to detect changes. You can also position the device to exceed the configured ZY angle so that changes are prevented, with the simulated phone not changing orientation when the device is placed on a table.

Also see [“Orientation application” on page 17](#).

5.3 Graphical Datalogger application

1. Launch the sensor toolbox software with the MMA865xFC accelerometer connected to the evaluation board.
2. Select the Graphical Datalogger application from the main launcher menu.
3. Click the Start a New Datalog button.
4. Move the device to observe how the data is graphed on the screen.

Also see [“Graphical Datalogger application” on page 21](#).

5.4 Non-Volatile Memory Datalogger application

1. Launch the sensor toolbox software with the MMA865xFC accelerometer connected to the evaluation board.
2. Select the NVM Datalogger application from the main launcher menu.
3. Click the Erase NVM Memory button.
4. Click the Start a New Datalog button.
5. Move the device around.
 Sharper movements are easier to see when the output is exported to a spreadsheet application.
6. When you have collected sufficient data, click the Stop Current Datalog button.
7. Click the Download to Excel button.
 The data in the non-volatile memory is exported as a comma-separated values (.csv) file.
 The file can be opened with a spreadsheet or text application.

Also see [“NVM Datalogger application” on page 26](#).

5.5 Directional Tap with FIFO application

1. Launch the sensor toolbox software with the MMA865xFC accelerometer connected to the evaluation board.
2. Select the Directional Tap Low-Power with FIFO demonstration from the main launcher menu.
3. Hold the device flat with the USB connection on the left.
4. Tap the top of the device.
 The z-axis indicator should switch to green and the Directional Tap window should display Z-Negative.
5. To demonstrate the device’s ability to detect taps, tap other sides of the device (or hold the device at an angle while tapping).

Also see [“Directional Tap with FIFO application” on page 31](#).

5.6 Directional Shake with FIFO application

1. Launch the sensor toolbox software with the MMA865xFC accelerometer connected to the evaluation board.
2. Select the Directional Shake Low-Power with FIFO demonstration from the main launcher menu.
3. Hold the device flat with the USB connection on the left.
4. Shake the device away from your body.
 The Y-axis indicator should switch to green and the Direction window should display Y Positive.
5. To demonstrate the device’s ability to detect shakes, shake the device along any of its axes.

Also see [“Directional Shake with FIFO application” on page 36](#).

6 Revision History

Table 20. Revision history

Revision number	Revision date	Description of changes
0	10/2012	• Initial release

How to Reach Us:

Home Page:

freescale.com

Web Support:

freescale.com/support

Information in this document is provided solely to enable system and software implementers to use Freescale products. There are no express or implied copyright licenses granted hereunder to design or fabricate any integrated circuits based on the information in this document.

Freescale reserves the right to make changes without further notice to any products herein. Freescale makes no warranty, representation, or guarantee regarding the suitability of its products for any particular purpose, nor does Freescale assume any liability arising out of the application or use of any product or circuit, and specifically disclaims any and all liability, including without limitation consequential or incidental damages. "Typical" parameters that may be provided in Freescale data sheets and/or specifications can and do vary in different applications, and actual performance may vary over time. All operating parameters, including "typicals," must be validated for each customer application by customer's technical experts. Freescale does not convey any license under its patent rights nor the rights of others. Freescale sells products pursuant to standard terms and conditions of sale, which can be found at the following address: freescale.com/SalesTermsandConditions.

Freescale, the Freescale logo, Altivec, C-5, CodeTest, CodeWarrior, ColdFire, C-Ware, Energy Efficient Solutions logo, Kinetis, mobileGT, PowerQUICC, Processor Expert, QorIQ, Qorivva, StarCore, Symphony, and VortiQa are trademarks of Freescale Semiconductor, Inc., Reg. U.S. Pat. & Tm. Off. Airfast, BeeKit, BeeStack, ColdFire+, CoreNet, Flexis, MagniV, MXC, Platform in a Package, QorIQ Qonverge, QUICC Engine, Ready Play, SafeAssure, SMARTMOS, TurboLink, Vybrid, and Xtrinsic are trademarks of Freescale Semiconductor, Inc. All other product or service names are the property of their respective owners.

© 2012 Freescale Semiconductor, Inc.

Document Number: MMA865xFCSTUG

Rev. 0

10/2012

