

Getting Started with HCS08 and CodeWarrior Using C

Revised for CodeWarrior v3.1 → v5.1

by: Stephen Pickering
East Kilbride, Scotland

1 Overview

The purpose of this application note is to demonstrate how easy it is to develop C code for an HCS08, using CodeWarrior®. A simple application is used in order to explain the techniques in developing an HCS08 application with CodeWarrior.

An important difference between the HC08 and the HCS08 is the inclusion of a suite of on-board hardware debugging facilities, designed to be used via the BDC (background debug controller). Code is debugged using the HCS08 BDM (background debug mode) pod, along with one of the demonstration/evaluation boards with an MC9S08GB60 device. The BDM pod used in the application is a P&E USB ML 12 (except where stated). Since BDM is an in-circuit debug methodology, the hardware could be the real application rather than a demo/evaluation board.

During the MC9S08GB60 launch, two boards (manufactured by Axiom) were made available: a low-cost demo board, and a more comprehensive evaluation board with LCD.

Contents

1	Overview	1
2	HCS08 Demonstration and Evaluation Boards	2
3	Introduction	3
3.1	What is an HCS08?	3
3.2	Background Debug Mode	5
3.3	HCS08 Serial Monitor	5
3.4	BDM or Monitor Mode?	5
4	Developing an Application with CodeWarrior	6
4.1	Description of Hardware Used	7
4.2	Creating a New Project CodeWarrior	8
4.3	Connecting the Hardware	14
4.4	Adding Files to the Project	20
4.5	Illuminate LED2 if SW2 is Pressed	24
4.6	Use PWM to Flash LED	25
4.7	Add interrupt on SW1	26
4.8	Set Clock Frequency	28
5	HCS08 CodeWarrior Development Tools	31
5.1	CodeWarrior	31
5.2	Additional HC(S)08 Help Included with CodeWarrior31	
5.3	Freescale	32
5.4	CodeWarrior for HC(S)08	32
6	CodeWarrior C and HCS08	35
6.1	Data Types	35
6.2	What a Project Consists of	36
6.3	Using CodeWarrior Device Definitions	37
6.4	Device file (MC9S08GB60.c)	37
6.5	Header File (MC9S08GB60.h)	37
6.6	Register and Bit Definitions	38
6.7	How Device Registers and Bits are Used	38
6.8	How Device Registers are Defined and Used	39
6.9	How Device Register Bit(s) are Defined / Used	40
6.10	Register Names Used with Multiple Peripherals	42
7	Frequently Asked Questions	42
8	References	53
9	Trademarks	56

HCS08 Demonstration and Evaluation Boards

Although the document refers to the MC9S08GB60, the concepts apply to all the HCS08 devices, with the appropriate substitutions (for device name, header file names, etc.).

If CodeWarrior version 3 (or higher) is not installed, refer to [Section 5, “HCS08 CodeWarrior Development Tools”](#).

If you are using CodeWarrior and/or HCS08 for the first time, and you are unsure about writing C code in this environment, refer to [Section 6, “CodeWarrior C and HCS08”](#), for a quick introduction to how the device specific features are used in the C programming language.

2 HCS08 Demonstration and Evaluation Boards

At the time of writing of this application note, the two Freescale HCS08 boards shown below are available for the HCS08. Both use the MC9S08GB60.

CAUTION

The version of CodeWarrior supplied may not support your chosen device or connection method; check web site for relevant service packs (see FAQs).

Using BDM cables: see FAQ for advice on using and how to update driver.

**M68DEMO908GB60
Demonstration Board**



- DB9 Serial Cable
- Documentation (CD)
- CodeWarrior for HC08 and HCS08
- Manual
- Batteries

**M68EVB908GB60
MC9S08GB60 Evaluation Board (EVB)**

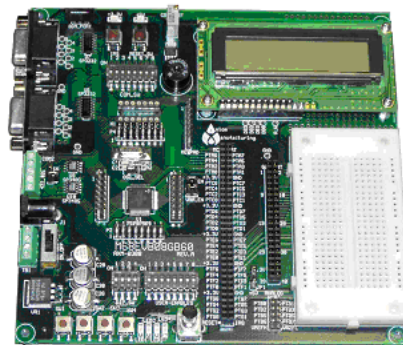

- DB9 Serial Cable
- Support CD
- CodeWarrior for HC08 and HCS08
- Manuals
- Power supply

3 Introduction

The aim of this application note is to help the first time user of HCS08 and CodeWarrior C to be able to:

- Understand the major differences between BDM and monitor mode
- Create a project using CodeWarrior
- Understand how to create and add files to a project
- Connect the hardware (demo or evaluation board) via monitor mode or BDM
- Run the code in the hardware
- Add code to illuminate LED according to a switch and step through code observing its operation
- Add interrupt handlers to a program
- Initialize and use the PWM to flash an LED with 25:75 duty cycle and inverse depending upon a switch
- Configure the FLL and on-board crystal for maximum performance.

In addition, the reader is provided with:

- An explanation of how CodeWarrior defines HCS08 devices and how the device registers are used with C
- Answers to commonly asked questions
- Pointers and references to further information
- Exercises in creating code.

As the exercises are not intended to be a lesson in typing, the appropriate files are included within the zip file AN2616SW.zip. The files main.c and M68DEMO908GB60.h are contained in the relevant sub directory within the zip file, and can simply be dragged from the zip file into the Sources directory of the CodeWarrior project at the appropriate point. For example, the directory 2.4 within the zip file contains the correct files for section 2.4. Alternatively, the code can be copied from an electronic copy (pdf) of the application note, and pasted into the relevant file using the CodeWarrior editor.

3.1 What is an HCS08?

The HCS08 is Freescale's latest range of 8-bit low-power, high-performance microcontrollers based on the HC08 core. The major differences from the HC08 are as follows.

- Core bus speed increased from 8 MHz to 20 MHz
- Hardware Background Debug Controller (BDC) and On-chip Debug Module (DBG), providing an additional two breakpoints in addition to the single breakpoint capability of the HC08, for improved debug and FLASH programming support
- Additional addressing modes for improved stack usage resulting in improved code density and performance

NOTE

Instruction cycle timings have changed on some instructions/addressing modes due to design requirements to enable higher frequency operation and care should be exercised with time critical code that was used on an HC08.

Introduction

The following block diagram shows the major elements of the MC9S08GB60.

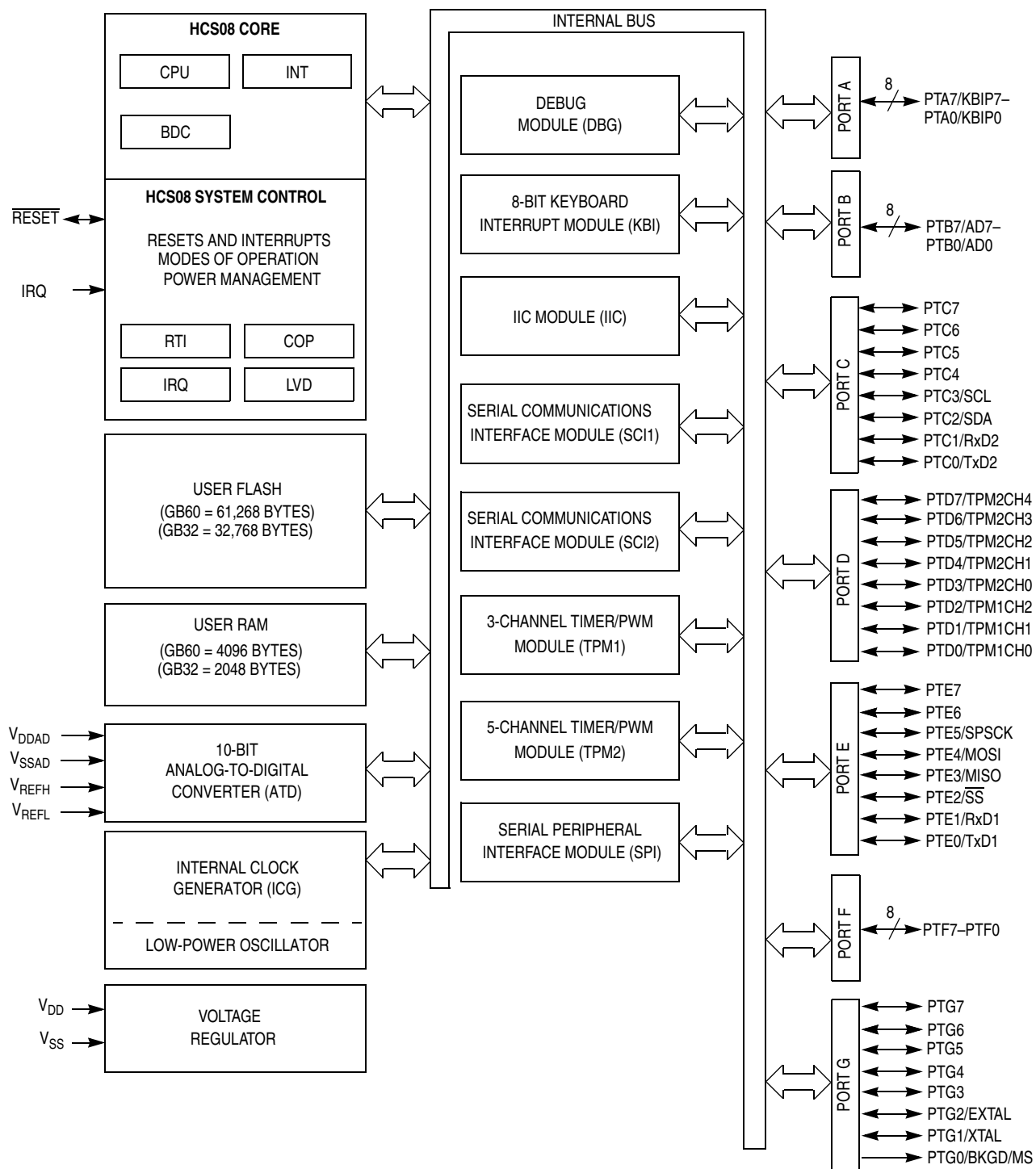

3.2 Background Debug Mode

Background debug mode (BDM) is a term used to refer to a mode of operation of the HCS08 where an in-circuit debugging technique is used. To use BDM, an interface typically referred to as a “BDM pod” is used to connect an external debugger, such as Freescale HCS08 True-Time Simulator and Real-Time Debugger, running on a PC, to the device being debugged.

A major advantage of Freescale’s BDM is its single pin operation, which allows all other pins to be used for the application (unlike, for example, JTAG, which requires four pins to operate).

The functional components of an HCS08 that provide this debugging capability are the BDC and DBG sections of the core.

- Background Debug Controller (BDC) — the module that controls access to the HCS08 core
- DeBuG module (DBG) — essentially a dual breakpoint controller and 8-word (16-bit) FIFO trace buffer

3.3 HCS08 Serial Monitor

As the HCS08 does not have a ROM-resident monitor like the HC08, Freescale has written a monitor; this is programmed into the HCS08 device and occupies about 1K of FLASH memory. The monitor enables debugging of an HCS08 through one of the on-board serial modules (SCI1) and provides a seamless integration with the CodeWarrior tools, providing almost all the functionality of BDM, albeit slightly slower.

NOTE

The HCS08 monitor is not the same as or compatible with the HC08 monitor commonly referred to as MON08.

3.4 BDM or Monitor Mode?

This application note was written with the use of a BDM pod (USB version), and verified using the HCS08 serial monitor mode and parallel BDM. Differences in operation between BDM and monitor mode are discussed, where appropriate.

The major advantages of using BDM over HCS08 serial monitor mode are as follows.

- Only one pin of the target device is used
- BDM does not use any peripherals
- BDM does not use any RAM or FLASH
- BDM cannot be locked out due to interrupts being disabled
- BDM can operate at any processor speed
- BDM can re-sync if processor speed changes during debug
- Device programming times are faster

4 Developing an Application with CodeWarrior

This section develops a simple application which illustrates the development process involved in using CodeWarrior.

The application uses the M68DEMO908GB60 board, and its five LEDs and four switches. When the complete application is built, the code will:

- Initialize peripherals
- Set up interrupt handler
- Configure a PWM waveform
- Turn off all LEDs
- Pulse LED5 with 75% duty cycle off; set LED3 on
- Set the processor speed with the FLL

and will then loop indefinitely around code which will:

- Cause an interrupt if SW1 is pressed:
 - The Interrupt handler will set LED1 (and latch it) according to state of switch SW4: i.e. ON if switch is pressed; otherwise it will be switched OFF
- Set or clear LED2 according to the state of switch SW2:
 - Pressing switch SW2 will set LED2, releasing SW2 will clear LED2
- Check the state of switch SW4 when switch SW3 is pressed, and set/clear LED3 and LED4 accordingly:
 - If SW4 is pressed
 - Set LED4, clear LED3 and Pulse LED5 with 75% duty cycle on
 - Otherwise
 - Set LED3, clear LED4 and Pulse LED5 with 75% duty cycle off

This application will be developed incrementally, showing the steps involved in creating the application and explaining the steps taken.

NOTE

Because of the differences between the demo board and the evaluation board, the buzzer on the evaluation board is used as an audible alternative to LED5 output on the demo board.

4.1 Description of Hardware Used

The MC9S08GB60 evaluation board (M68EVB908GB60) or the low-cost demo board (M68DEMO908GB60) may be used. The application chosen for the demonstration will work on either board; however, setting up the boards to enable the switches, LEDs, and monitor mode will be different.

4.1.1 Setting up the Demo Board

To use the demo board with this application note, the LEDs and switches must be suitably configured as follows.

- The five jumpers on LED_EN must be installed to enable the LEDs
- To enable HCS08 serial monitor mode, the serial port SCI transmit and receive must be connected to the DB9 header, and power applied to the RS232 driver; this is accomplished by installing jumpers 1, 2, and 3 on COM_EN

4.1.2 Setting up the Evaluation Board

To use the evaluation board with this application note, the LEDs and switches must be suitably configured as follows.

- The USER-ENABLES dip switch 2 should be set ON; this connects the switches SW[1:4] on the evaluation board to PORTA[4:7]
- The USER-ENABLES dip switches 5, 6, 7, and 8 should be set ON; this connects the LEDs on the evaluation board to PORTF[0:3]
- The COM_SW dip switch 8 should be set to ON; this enables the onboard buzzer
- To enable HCS08 serial monitor mode, the serial port SCI receive must be connected to the DB9 header via the RS232 driver; this is accomplished by setting switch 1 of COM_EN ON

4.2 Creating a New Project CodeWarrior

This section discusses the project types that can be created within CodeWarrior.

CodeWarrior has a project wizard that guides you through the process of creating a project.

1. Create a new project by selecting “New...” from the File menu:

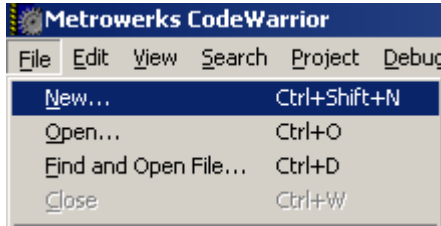

Or by pressing the New button:



either of which will invoke the project creation dialog box shown below.

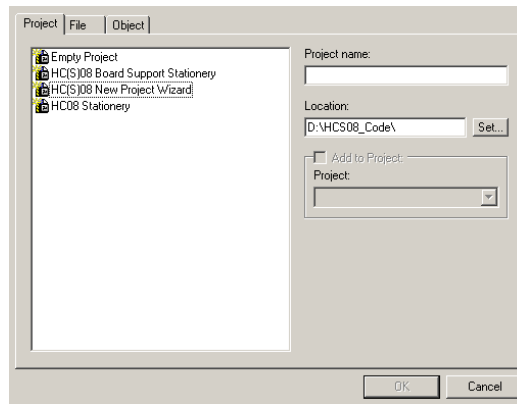

When creating a new project, the project wizard presents four main options:

Empty Project	Creates the very minimum of files required, essentially just creating the project file.
HC(S)08 Board Support Stationery	Provided as a quick start to use one of the demo boards, provides some skeleton code (or demo), and can be used to get accustomed quickly to CodeWarrior and a board.
HC(S)08 New Project Wizard	Used to choose the appropriate device on which to base the project, and is the most commonly used wizard.
HC08 Stationery	Provides the HC08 board support of the previous CodeWarrior for the HC08 and is not used for HCS08 devices or board.

2. Select “HC(S)08 New Project Wizard”.

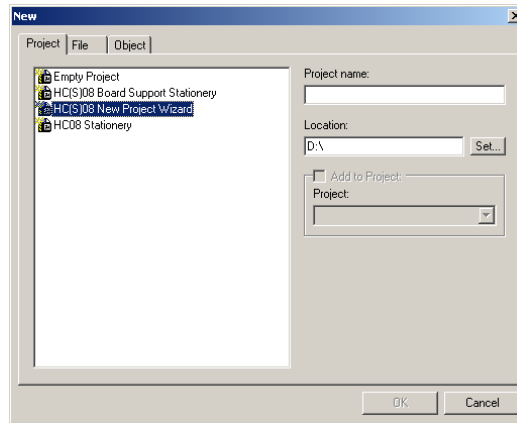

3. Select **Set...** button to set the “Location”. This allows you to select the parent directory for the project:

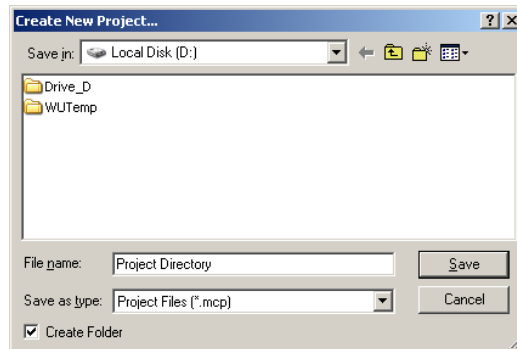

4. Once the root directory for the project has been located, enter the directory to be created (for example, “Project Directory”, as shown in the diagram above).
5. Select **Save**, and the new project directory / file name will be displayed.
6. In the “Project name:” field, you may enter the name of the project file to be created (by default it will be the same as the directory name):

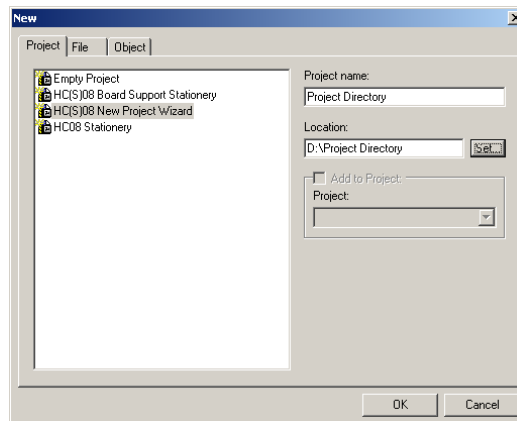

7. Select . A popup will appear which lists the possible devices:

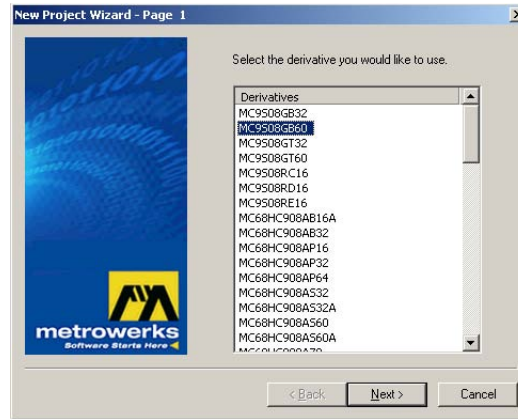

8. Select your desired device (MC9S08GB60 in this example), and press , which will bring up the language dialog box:

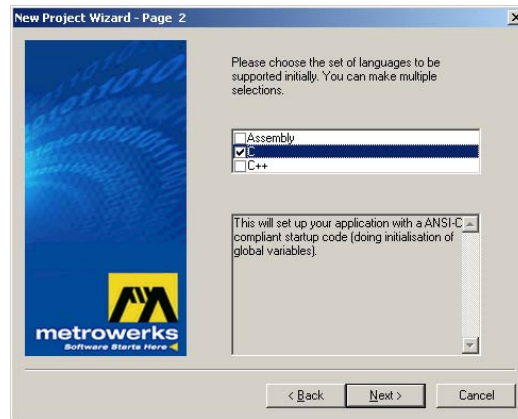

9. Select C and press . This will bring up the processor expert dialog box:

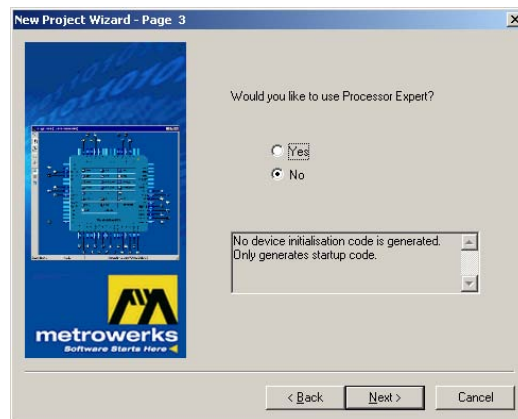

As this application note is about using C with the HCS08 and CodeWarrior, “Processor Expert” is not selected. If you wish to use “Processor Expert”, refer to the online help (and examples) before proceeding; otherwise proceed to 10.

10. Select **Next >**, and the PC-lint option will appear:

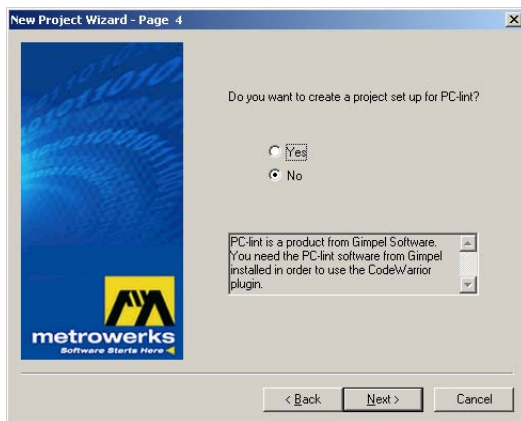

11. Unless you have purchased PC-lint and wish to use it, select “No” and press **Next >**, and the floating point support dialog box will appear:

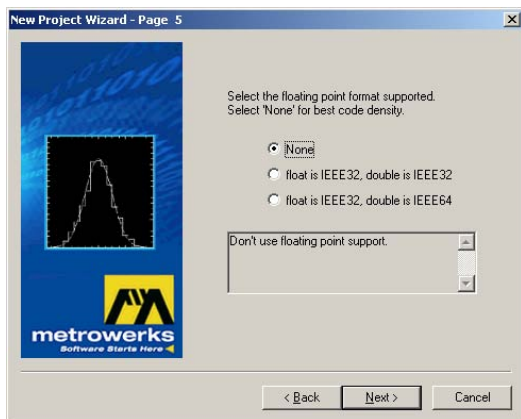

12. As the application will not use floating point support, select “None” and press **Next >**. The memory model selection will appear:

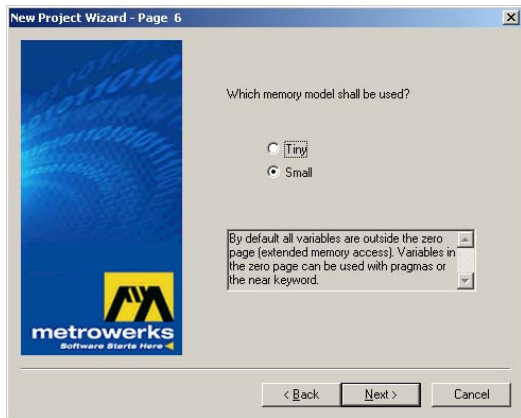

13. Select “Small” and press . The connection dialog will appear:

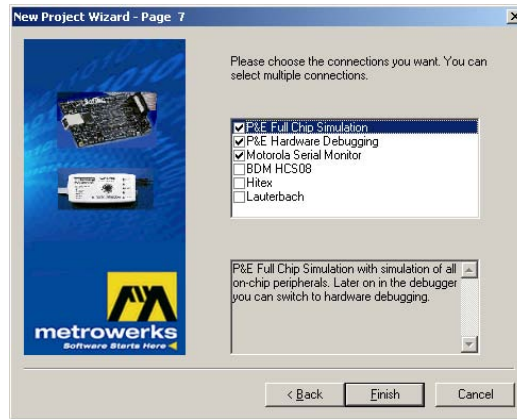

By selecting “P&E Full Chip Simulation”, “P&E Hardware Debugging” and “Freescale Serial Monitor”, it will be possible to use either simulation, the serial monitor within the HCS08 FLASH, or BDM to debug code.

NOTE

There is no code overhead as a result of choosing multiple connection methods.

Enabling all the likely connection methods makes switching between the different targets easier. For example, initially the development could use the simulator and swap to the HCS08 serial monitor or BDM method as required.

The supported target devices are listed in the following table.

Target		Comment
P&E Full Chip Simulation	P&E FCS	This option allows the on-chip peripherals to be emulated and software simulation of the peripherals.
P&E Hardware Debugging	P&E ICD	This option enables connection to the device via P&E hardware for HC08 and other P&E hardware such as USB HCS08/HCS12 Multilink.
Freescale Serial Monitor	Monitor	This option connects to the HCS08 device through the monitor ROM within the HCS08 device.
BDM HCS08	BDM	Legacy support only — not recommended for use (supports parallel BDM Multilink only). Superseded by P&E Hardware Debugging. Will be removed in future versions of CodeWarrior.
Hitex		Refer to manufacturer's detail.
Lauterbach		Refer to manufacturer's detail.

Project creation is now complete!

4.2.1 CodeWarrior Generated Project

Once the project wizard has finished, a project, including a skeleton application, has been created. The project window will look something like:

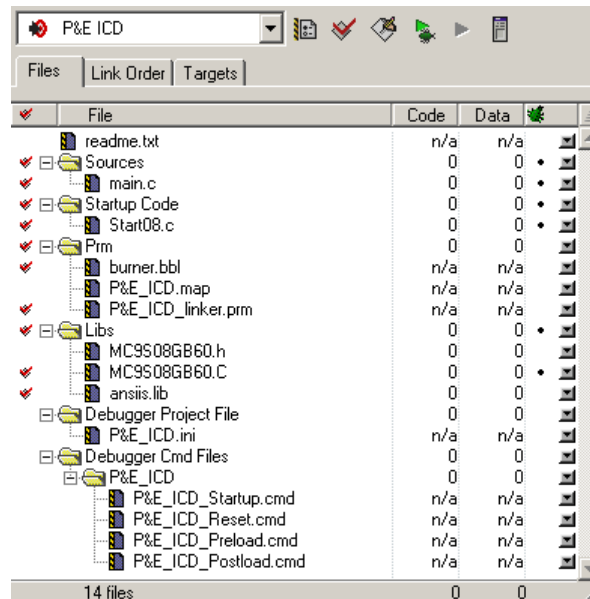

Details of the files and directories are discussed in [Section 6, “CodeWarrior C and HCS08”](#).

4.2.2 Initial Code

The new project wizard creates enough code to actually load into a board and run/debug, the main program (main.c) being:

```
#include <hidef.h> /* for EnableInterrupts macro */
#include <MC9S08GB60.h> /* include peripheral declarations */

void main(void) {
    EnableInterrupts; /* enable interrupts */
    /* include your code here */
    for(;;) {
        __RESET_WATCHDOG(); /* kicks the dog */
    } /* loop forever */
}
```

4.3 Connecting the Hardware

The preferred method of connecting the target device is via a BDM pod, but a standard RS232 serial connection to the monitor of the HCS08 can also be used.

The following sections discuss the BDM and HCS08 serial monitor connection.

4.3.1 Background Debug Mode (BDM)

To set up: connect the BDM pod to the PC with the appropriate cable supplied with the pod (for example, parallel cable, USB cable), connect the BDM pod to the target board, paying particular attention to ensure correct alignment of pin 1 of the BDM cable with the BDM connector on the board. Refer to the appropriate BDM and board for additional help.

4.3.2 Selecting a BDM

The BDM on the HCS08 evolved from the BDM used on the HCS12 (BDM Version 4).

The preferred method of connecting to an S08 device for code development or debugging is using one of the following BDM interfaces:

- M68MULTILINK12 (P&E BDM Multilink)
- M68MULTILINKS08 (NOT the similarly named M68MULTILINK08)
- P&E USB ML12 / P&E USB HCS08/HCS12 MULTILINK
- P&E Cyclone Pro

NOTE

M68MULTILINK08 and M68MULTILINKS08 are NOT the same. The M68MULTILINK08 is a MON08 interface for use with HC08 devices; the M68MULTILINKS08 is a BDM pod for HCS08 that is also compatible with HC12 and HCS12.

4.3.3 HCS08 Serial Monitor Mode

To set up: connect the serial cable to the PC, and connect the other end to SCI1 on the target board. Refer to the appropriate board manual for additional help.

The HCS08 devices supplied with the demo and evaluation boards are pre-programmed with the HCS08 serial monitor. Refer to Freescale application note “AN2140/D — Serial Monitor for MC9S08GB/GT” for a full description of its capability.

4.3.4 Running the Code

The next two sub-sections discuss the use of HCS08 serial monitor mode or BDM as the method of connecting to the target device on either the evaluation or demo board. There are several differences in the dialog boxes and in the progression through the target connection; these differences are detailed in the following sections.

4.3.5 Using Monitor

If you are using BDM, skip this section; go directly to [Section 4.3.6, “Using BDM”](#).

1. From the target connection pull-down, ensure that “Monitor” is selected:

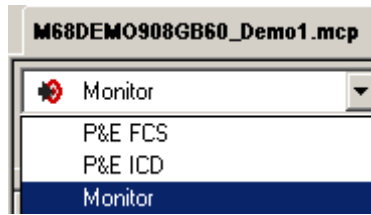

2. Enable monitor mode on the target. (For the demo and evaluation boards, press switch 4, whilst applying power, or whilst pressing the reset switch on the evaluation board).
3. Select Debug (). This compiles and links the code, and invokes the True-Time simulator and Real-Time debugger (the HCS08 debugger). The debugger will then proceed to try to establish connection with the target device, by trying all the baud rates:

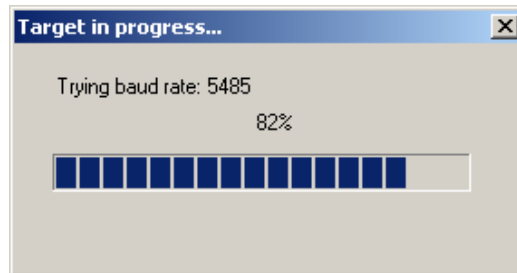

If the debugger fails to communicate with the device after going through all possible baud rates, a window suggesting possible causes will pop up:

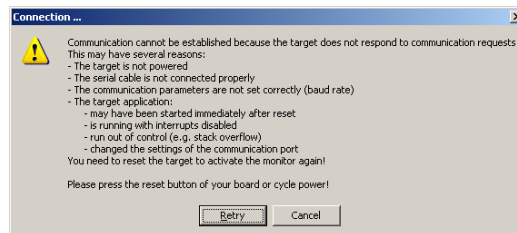

Power the board off and then on again (holding down switch SW4), and press the button. Communication should now be established.

Once communications have been established between the debugger and the device, the debugger will pop up a few dialog windows as it prepares the device, ready for debugging; the first dialog box is the monitor preload:

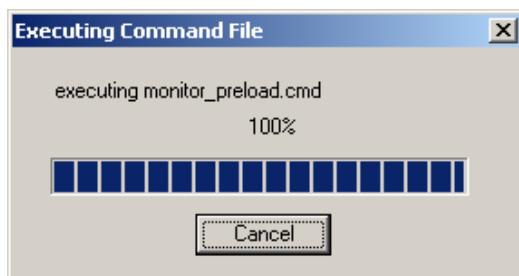

This will be followed by the FLASH erase/programming and the monitor post load commands. Skip the next section; go directly to [Section 4.3.7, “Debugging — Communications Established”](#).

4.3.6 Using BDM

1. From the target connection pull-down, ensure that “P&E ICD” is selected:

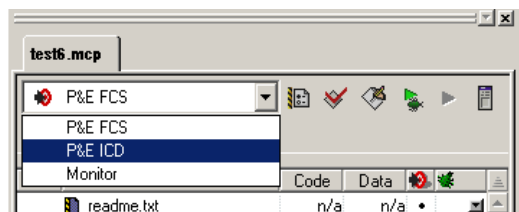

2. Select Debug (). This compiles and links the code, and invokes the True-Time simulator and Real-Time debugger (the HCS08 debugger). As this is the first time the code has been run, the debugger does not know which BDM device is to be used to connect to the target, so it pops up a dialog box for configuration (defaulting to use LPT1):

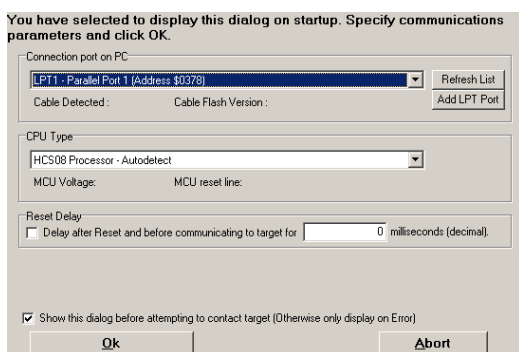

CodeWarrior knows the CPU Type is an HCS08, because that is the project type we created. The debugger will list the pods it can see on the pull-down list. If the pod being used is not shown, ensure it is connected correctly, then press the “Refresh List” button. The pod should now appear on the list.

Ensure the relevant pod is highlighted; in this example, P&E USB ML 12 is being used:

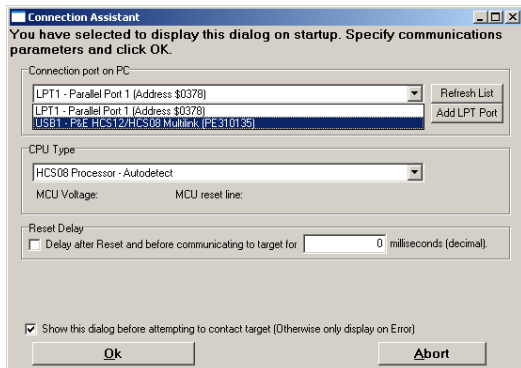

3. Select **Ok**.

The BDM firmware version will be checked, and, if the pod has old firmware, a dialog box will appear, allowing it to be upgraded:

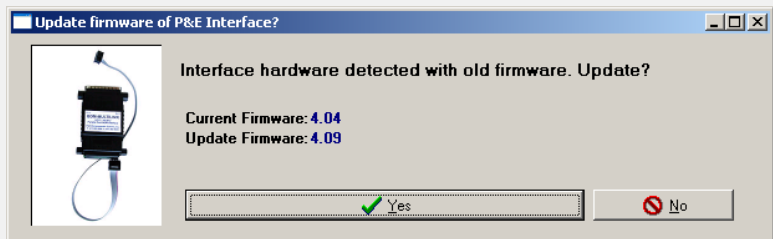

Select **Yes**, and a dialog pops up showing the reprogramming of the pod:

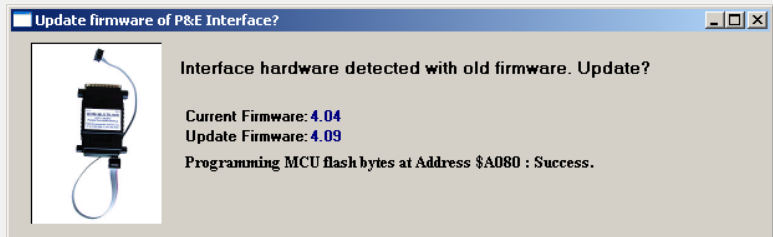

Select **Ok**.

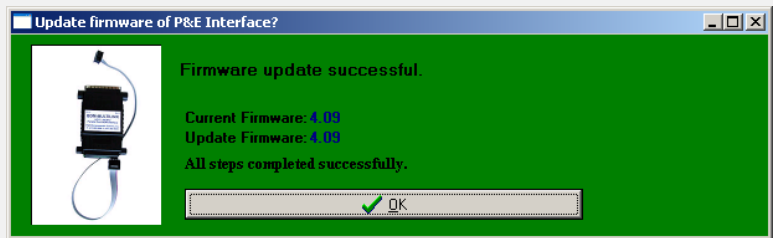

NOTE

This will occur only with BDM pods that have old firmware. Once upgraded, the prompt will not recur for a pod that has been updated (unless CodeWarrior is updated and new code is available).

Next, a dialog pops up asking to erase and program Flash:

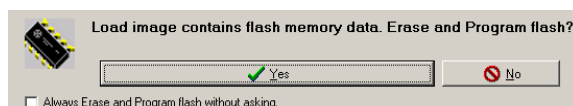

- Select to proceed. Another window pops up showing the erasure and programming of the Flash:

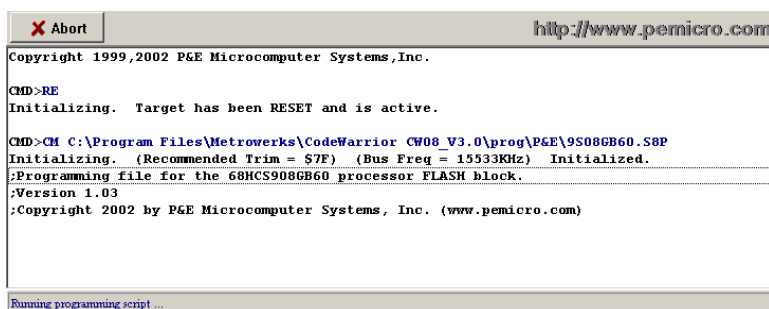

At this point, the code has been programmed in the device, and the debugger shows the following windows.

4.3.7 Debugging — Communications Established

Once communication (BDM or Monitor) has been established with the device, the debugger will show its debug window:

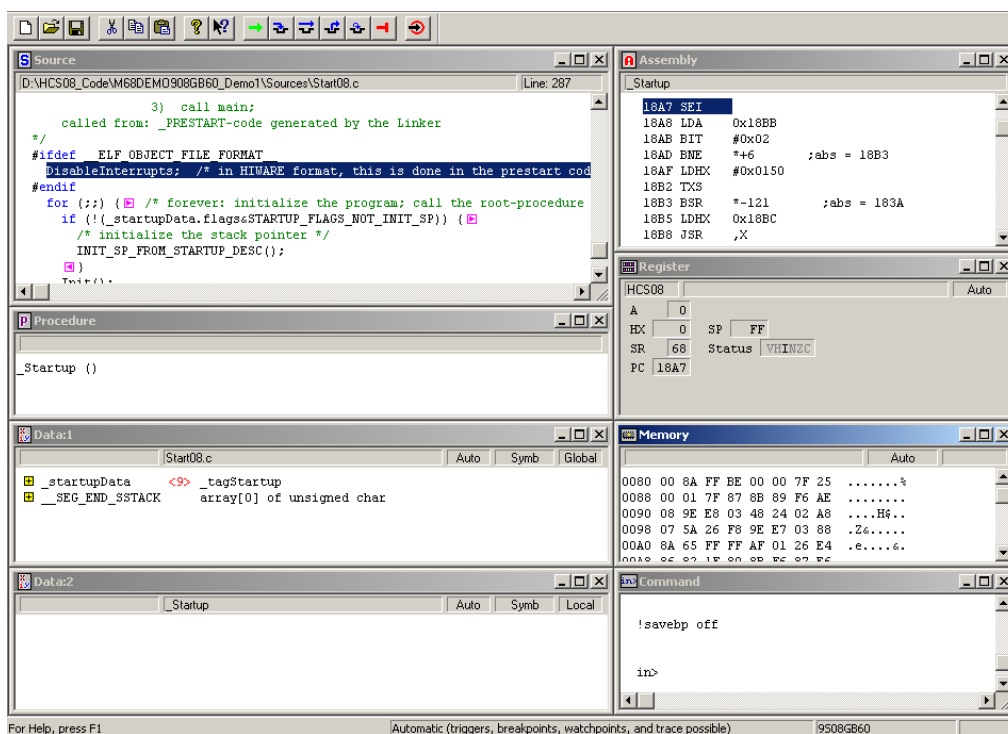







NOTE

If the debugger does not erase the FLASH, it is almost certainly operating in simulation mode. Refer to the Frequently Asked Questions section for information on how to select the relevant in-circuit debug mode.

Apart from a few exceptions, debugging will be the same whether the monitor or BDM is used. The notable difference is that, when debugging using the HCS08 serial monitor, loss of communication between the debugger and the device is possible due to the fact that the monitor is code within the FLASH, interrupt driven and susceptible to errors in the user code, for example, disabling interrupts or user code runaway.

The monitor is in protected FLASH but, if it is erased, it will have to be reprogrammed. Refer to Frequently Asked Questions for more information on reprogramming the monitor.

Buttons of interest from the debugger window are::

	RUN	Run code from current pc location until either halted or reset
	STEP INTO	Execute one C statement; enter into functions
	STEP OVER	Execute one C statement or complete function
	STEP OUT	Execute remaining C statements in function
	Assembly Step	Step one assembly language instruction
	HALT	Stop the executing program
	RESET	Hardware reset

At this point, running the application will appear to have no effect, as there is no code that actually does anything. The following sections add code that can be run, and that performs real functions.

NOTE

For a detailed discussion of the HCS08 on-chip debug features using the CodeWarrior interface, refer to application note, “AN2596 — Using the HCS08 family On-Chip Debug System.”

4.4 Adding Files to the Project

Multiple files can be added to a project to allow a program to be split into logical sections for easier development. As an example, a header file defining the switches and LEDs for the demo and evaluation boards will be added to the project to demonstrate the process.

4.4.1 Header File for Demo Board

A small header file is created to give more meaningful names to the LEDs and switches on the demo board for use in the application. Another benefit of using an application specific header file is that code will be easier to modify for different devices or applications, if meaningful names are used rather than the port or pin names; for example, in a real application, LED2 may be the STOP LED.

NOTE

The header will work with the demo board and the evaluation board, as only a subset of the evaluation board is used.

4.4.2 Add a File to a Project

In order to add a new file to a project, the file must exist; therefore, a new file must be created. To do this:

1. From the File menu, select “New...”:

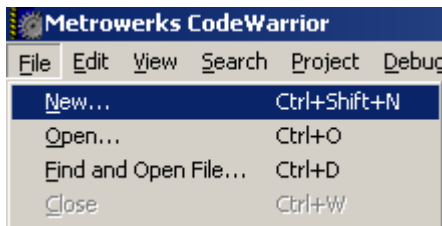

or press the New button:



The new dialog window will appear:

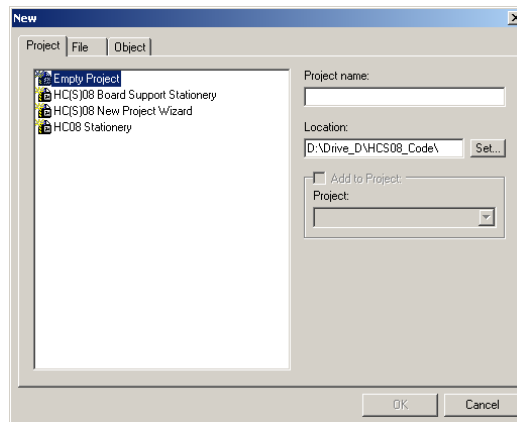

2. Select the “File” tab. There will be one option — create a file:

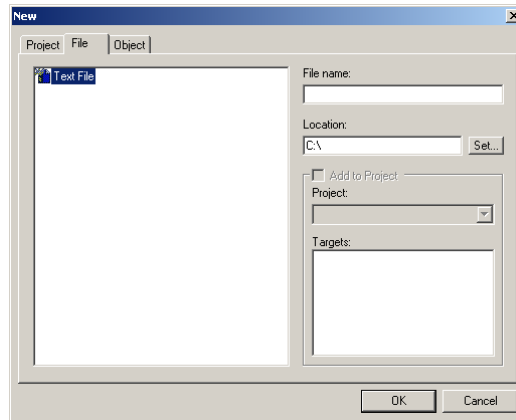

3. A dialog box will appear. Select **Set...** button, navigate to the Sources directory within the project directory, and enter the name of the file to create (for example, M68DEMO908GB60.h):

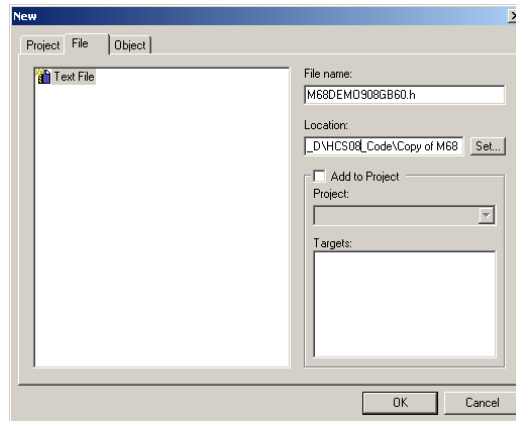

4. Select **Ok**. This will create an empty text file in the appropriate directory and bring up a text editor window for the file:

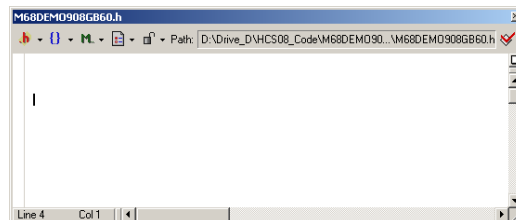

5. Enter the following text into the file:

```

/* File: M68DEMO908GB60.h*/

/* include peripheral declarations */
#include <MC9S08GB60.h>

/*define value for led's when on and off*/
#define ON 0
#define OFF 1

/*define value for switches when up (not pressed) and down (pressed)*/
#define UP 1
#define DOWN 0

/*define led's*/
#define LED1 PTFD_PTFD0
#define LED2 PTFD_PTFD1
#define LED3 PTFD_PTFD2
#define LED4 PTFD_PTFD3
#define LED5 PTFD_PTFD4

/*define switches*/
#define SW1 PTAD_PTAD4
#define SW2 PTAD_PTAD5
#define SW3 PTAD_PTAD6
#define SW4 PTAD_PTAD7

```

6. After entering the text, select the close window (). This will bring up the save dialog:

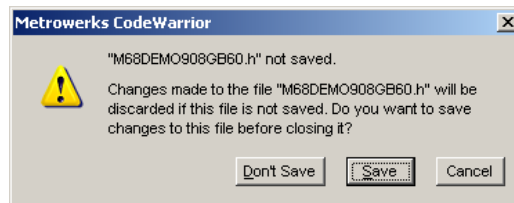

7. Press to save the changes made to the file.

4.4.3 Add File to Project

1. To add the header file to the project, select the desired directory (for example, “Sources”) in the project manager and press the right mouse button. The following dialog will appear:

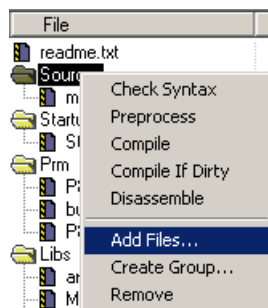

2. Select “Add Files...”. This will pop up the file dialog window, which is used to locate the file:

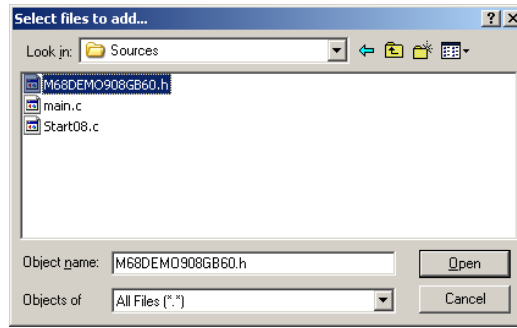

Select  to add the file to the project and associate it with the “Sources” folder:

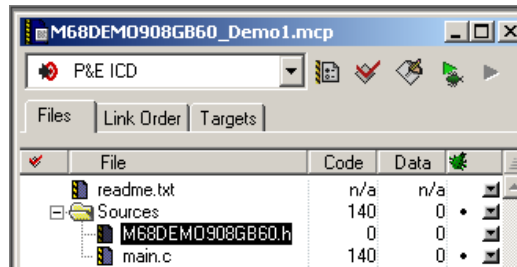

A popup will appear showing a list of available targets that the file can be added to. Select all:

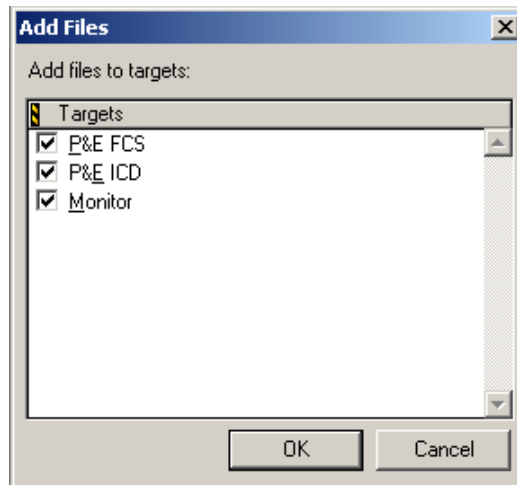

4.5 Illuminate LED2 if SW2 is Pressed

Let's add some code to light up LED2 if SW2 is pressed. Double-click on "main.c" in the project manager to invoke the editor.

First, add an include statement to use our header file for the demo board:

```
#include "M68DEMO908GB60.h"
```

Next, configure PORTF for output (LEDs) and PORTD for input (switches):

```
PTADD = 0;    //initialize as input (Data Direction Register)
PTAPE = 0xf0; //Pullups on upper 4 bits

/*initialize bits 0-3 of Port F as outputs (connected to led's)*/
PTFDD = 0x0f;
LED1 = OFF;
LED2 = OFF;
LED3 = OFF;
LED4 = OFF;
LED5 = OFF;
```

Code to turn on LED2 depending upon the state of SW2 would be:

```
LED2 = SW2;
```

To edit the main.c file, simply double-click on the file name within the project window; this will invoke the file editor. By adding this code within the main program, as illustrated below, LED2 will be turned on for as long as SW2 is pressed. The resulting program is:

```
#include <hidef.h> /* for EnableInterrupts macro */
#include <MC9S08GB60.h> /* include peripheral declarations */

#include "M68DEMO908GB60.h"

void main(void) {
    EnableInterrupts; /* enable interrupts */
    /* include your code here */







    PTADD = 0;    //initialize as input (Data Direction Register)
    PTAPE = 0xf0; //Pullups on upper 4 bits

    /*initialize bits 0-3 of Port F as outputs (connected to led's)*/
    PTFDD = 0x0f;
    LED1 = OFF;
    LED2 = OFF;
    LED3 = OFF;
    LED4 = OFF;
    LED5 = OFF;

    for(;;) {
        __RESET_WATCHDOG(); /* kicks the dog */

        LED2 = SW2;
    } /* loop forever */
}
```

4.5.1 Run the Code

- In CodeWarrior, press the Debug button (). This compiles the program and produces an executable file, which invokes the debugger. The debugger erases the FLASH and downloads the code to the device.
- In the debugger, press the RUN button (); the application will run.
- The running application can be confirmed by pressing SW2 and seeing LED2 light.
- Press the STOP button (); LED2 will maintain its state prior to the stop being pressed.
- Press the STEP OVER button () to advance the code; the debugger will advance one C instruction with each press.
- With the debugger pointing to the statement LED=SW2, press SW2 and press the STEP OVER button () once; LED2 will be turned on.
- Press the RUN button () to restart the program; this will cause LED2 to be on when SW2 is pressed

4.6 Use PWM to Flash LED

Adding the following code to the program will configure the PWM and will flash LED5 (or buzzer on evaluation board), using LED3 and LED4 to indicate the duty cycle selected by switch SW4, when changed by the operation of switch SW3.

```
#include <hidef.h> /* for EnableInterrupts macro */
#include <MC9S08GB60.h> /* include peripheral declarations */
#include "M68DEMO908GB60.h"

#define PRESCALAR 7
#define MODULUS 32768
#define DUTY75 (MODULUS-(MODULUS/4))
#define DUTY25 (MODULUS/4)

void main(void) {
    EnableInterrupts; /* enable interrupts */
    /* include your code here */

    PTADD = 0; /*initialize as input (Data Direction Register)
    PTAPE = 0xf0; //Pullups on upper 4 bits

    /*initialize bits 0-3 of Port F as outputs (connected to led's)*/
    PTFDD = 0x0f;
    LED1 = OFF;
    LED2 = OFF;
    LED3 = OFF;
    LED4 = OFF;
    LED5 = OFF;

    /*Initialize timer TPM1 channel, assumes not touched since reset!*/
    TPM1SC_CLKSA = 1; /*Select BUS clock*/
    TPM1SC_CLKSB = 0;
    TPM1SC_PS = PRESCALAR; /*clock source divided by prescalar*/
    TPM1MOD = MODULUS; /*set Counter modulus*/
    /*configure PWM mode and pulse*/
    TPM1C0SC_MS0B = 1; /*MS0B=1, MS0A=0; << Edge align PWM*/
    TPM1C0SC_ELS0A = 1; /*Select low as true*/
```

```

TPM1COV = DUTY25; /*select final divider (duty cycle)*/
LED4 = ON;



for(;;) {
    _RESET_WATCHDOG(); /* kicks the dog */
    LED2 = SW2;

    if(SW3==DOWN){
        /*Switch pressed*/
        if(SW4==DOWN){/**/
            TPM1COV = DUTY75;/**/
            LED3 = ON;/**/
            LED4 = OFF;/**/
        }else{
            TPM1COV = DUTY25;/**/
            LED3 = OFF;/**/
            LED4 = ON;/**/
        }
    }

} /* loop forever */
}

```

4.6.1 Invoke the Debugger

- In CodeWarrior, press the Debug button (). This compiles the program and produces an executable file, which invokes the debugger. The debugger erases the FLASH and downloads the code to the device.
- In the debugger, press the RUN button (); the application will run.
- LED3 will be illuminated and LED5 (or buzzer on evaluation board) will be pulsed.
- Pressing SW3 whilst holding down SW4 will turn off LED3, light LED4, and change the duty cycle of LED5 (buzzer).
- Pressing SW3 will revert to LED3 illuminated, and the duty cycle of LED5 (buzzer) will revert back to the original duty cycle.
- LED2 will still function according to the state of SW2.

4.7 Add interrupt on SW1

CodeWarrior supports several ways of incorporating interrupts. Refer to the Frequently Asked Questions section for a discussion of other methods.

As the vector for the keyboard interrupt is 22, add a macro to define VNkeyboard in the header file M68DEMO908GB60.h:

```

#define VNkeyboard 22

```

The method chosen is the interrupt keyword with vector number. This method has the advantage that the interrupt routine is self-declaring, and only one file is involved in its declaration:

```
interrupt VNkeyboard void intSW1(){
    LED1 = SW4;
    KBI1SC_KBACK = 1; /*acknowledge interrupt*/
}
```

The code to initialize the interrupts is:

```
KBI1PE_KBIPE4 = 1;
KBI1SC_KBIE = 1;
```

Add this code to the main program:

```
#include <hidef.h> /* for EnableInterrupts macro */
#include <MC9S08GB60.h> /* include peripheral declarations */
#include "M68DEMO908GB60.h"

#define PRESCALAR 7
#define MODULUS 32768
#define DUTY75 (MODULUS-(MODULUS/4))
#define DUTY25 (MODULUS/4)

interrupt VNkeyboard void intSW1(){
    LED1 = SW4;
    KBI1SC_KBACK = 1; /*acknowledge interrupt*/
}

void main(void) {
    EnableInterrupts; /* enable interrupts */
    /* include your code here */

    PTADD = 0; //initialize as input (Data Direction Register)
    PTAPE = 0xf0; //Pullups on upper 4 bits

    /*initialize bits 0-3 of Port F as outputs (connected to led's)*/
    PTFDD = 0x0f;
    LED1 = OFF;
    LED2 = OFF;
    LED3 = OFF;
    LED4 = OFF;
    LED5 = OFF;

    /*Initialize timer TPM1 channel, assumes not touched since reset!*/
    TPM1SC_CLKSA = 1; /*Select BUS clock*/
    TPM1SC_CLKSB = 0;
    TPM1SC_PS = PRESCALAR; /*clock source divided by prescalar*/
    TPM1MOD = MODULUS; /*set Counter modulus*/
    /*configure PWM mode and pulse*/
    TPM1COSC_MS0B = 1; /*MS0B=1, MS0A=0; << Edge align PWM*/
    TPM1COSC_ELS0A = 1; /*Select low as true*/

    TPM1COV = DUTY25; /*select final divider (duty cycle)*/
    LED4 = ON;

    KBI1PE_KBIPE4 = 1;
    KBI1SC_KBIE = 1;
```

```

for(;;) {
    __RESET_WATCHDOG(); /* kicks the dog */
    LED2 = SW2;



    if(SW3==DOWN){
        /*Switch pressed*/
        if(SW4==DOWN){/**/
            TPM1C0V = DUTY75;/**/
            LED3 = ON;/**/
            LED4 = OFF;/**/
        }else{
            TPM1C0V = DUTY25;/**/
            LED3 = OFF;/**/
            LED4 = ON;/**/
        }
    }
} /* loop forever */
}

```

NOTE

Do not forget to add the #define statement to the header file M68DEMO908GB60.h.

4.7.1 Invoke the Debugger

- In CodeWarrior, press the Debug button (). This compiles the program and produces an executable file, which invokes the debugger. The debugger erases the FLASH and downloads the code to the device.
- In the debugger, press RUN (); the application will run.
- Pressing SW1 will cause an interrupt, which will read SW4 and set LED1 accordingly.
- LED2, LED3, LED4 and LED5 (buzzer) will still function as before.

4.8 Set Clock Frequency**CAUTION**

An important consideration in setting the FLL is that, if the HCS08 serial monitor is being used for debugging, then changing the processor speed from that set by the monitor will cause CodeWarrior to lose control of the device, unless the SCI speed is also adjusted to take account of the change in processing speed. BDM operation is unaffected by changes in processor speed, as it either has a separate fixed frequency clock (as MC9S08GB60), or the BDM pod has the ability to re synchronize in the event of the device changing frequency.

The Internal Clock Generator (ICG) used within the MC9S08GB60 has an FLL that allows a frequency higher than the reference source (for example, crystal or internal oscillator) to be generated. This enables the processor frequency to be optimized in terms of power consumption and performance.

The demo board includes a 32.768 kHz crystal, while the evaluation board has a 4 MHz crystal on board. The crystals allow the device to operate at a maximum frequency of 18.87 MHz for the demo board (32.768 kHz) and 20 MHz for the evaluation board (4 MHz).

The formula for calculating the bus frequency is:

$$\text{Bus frequency} = ((f_{\text{IRG}} \div 7) \times P \times N \div R) \div 2$$

Where

- P = 1 or 64 (high or low frequency range)
- N[0:7] = {4, 6, 8, 10, 12, 14, 16, or 18}
- R[0:7] = 1, 2, 4, 8, 16, 32, 64, or 128

Code to configure the clock in C would be:

```

/*configure Internal Clock Generator [ICG]*/
/*MFD[]={4,6,8,10,12,14,16,18}*/
ICGC2_MFD = 7; /*32KHz crystal, demo board.
                For 4MHz crystal (eval board):
                ICGC2_MFD = 3
                */

ICGC2_RFD = 0; /* RFD[]={1,2,4,8,16,32,64,128}*/

ICGC1 = 0b00111000; /*32KHz crystal, demo board.
                    For 4MHz crystal (eval board):
                    ICGC1 = 0b01111000;
                    */

while((ICGS1_LOCK==0) || (ICGS1_ERCS==0)){
    /*Ensure COP doesn't reset device whilst waiting for clock lock*/
    __RESET_WATCHDOG(); /* kicks the dog */
}
ICGC2_LOCRE = 1; /*enable reset if clock fails*/
    
```

The “while” loop ensures that the external clock has been selected (ICGS1_ERCS) and that the FLL has locked to the desired frequency (ICGS1_LOCK).

The final program is:

```
#include <hidef.h> /* for EnableInterrupts macro */
#include <MC9S08GB60.h> /* include peripheral declarations */
#include "M68DEMO908GB60.h"

#define PRESCALAR 7
#define MODULUS 32768
#define DUTY75 (MODULUS-(MODULUS/4))
#define DUTY25 (MODULUS/4)

interrupt VNkeyboard void intSW1(){
    LED1 = SW4;
    KBI1SC_KBACK = 1;/*acknowledge interrupt*/
}

void main(void) {
    EnableInterrupts; /* enable interrupts */
    /* include your code here */

    PTADD = 0; //initialize as input (Data Direction Register)
    PTAPE = 0xf0; //Pullups on upper 4 bits

    /*initialize bits 0-3 of Port F as outputs (connected to led's)*/
    PTFDD = 0x0f;
    LED1 = OFF;
    LED2 = OFF;
    LED3 = OFF;
    LED4 = OFF;
    LED5 = OFF;

    /*Initialize timer TPM1 channel, assumes not touched since reset!*/
    TPM1SC_CLKSA = 1;/*Select BUS clock*/
    TPM1SC_CLKSB = 0;
    TPM1SC_PS = PRESCALAR;/*clock source divided by prescalar*/
    TPM1MOD = MODULUS;/*set Counter modulus*/
    /*configure PWM mode and pulse*/
    TPM1C0SC_MS0B = 1; /*MS0B=1, MS0A=0; << Edge align PWM*/
    TPM1C0SC_ELS0A = 1; /*Select low as true*/

    TPM1COV = DUTY25;/*select final divider (duty cycle)*/
    LED4 = ON;

    KBI1PE_KBIPE4 = 1;
    KBI1SC_KBIE = 1;

    /*configure Internal Clock Generator [ICG]*/
    /*MFD[]={4,6,8,10,12,14,16,18}*/
    ICGC2_MFD = 7; //32KHz crystal, demo board.
    // For 4MHz crystal (eval board):
    // ICGC2_MFD = 3
    /*

    ICGC2_RFD = 0; // RFD[]={1,2,4,8,16,32,64,128}*/

    ICGC1 = 0b00111000; //32KHz crystal, demo board.
    // For 4MHz crystal (eval board):
    // ICGC1 = 0b01111000;
    /*

    while((ICGS1_LOCK==0)|| (ICGS1_ERCS==0)){
        /*Ensure COP doesn't reset device whilst waiting for clock lock*/
        __RESET_WATCHDOG(); /* kicks the dog */
    }
    ICGC2_LOCRE = 1; /*enable reset if clock fails*/
```

```
for(;;) {
    __RESET_WATCHDOG(); /* kicks the dog */
    LED2 = SW2;

    if(SW3==DOWN){
        /*Switch pressed*/
        if(SW4==DOWN){/**/
            TPM1COV = DUTY75;/**/
            LED3 = ON;/**/
            LED4 = OFF;/**/
        }else{
            TPM1COV = DUTY25;/**/
            LED3 = OFF;/**/
            LED4 = ON;/**/
        }
    }
} /* loop forever */
}
```

NOTE

It is important to set the RANGE, REFS and CLKS in the ICGC1 register together as a single byte store (for example, STA or MOV instruction), and not by read-modify-write instructions (BSET or BCLR), as attempting to set these bits individually may result in the clock mode being locked after the first write to the ICGC1 register.

For more information on setting system clock, refer to the relevant data sheet and to Application Note AN2494 — *Configuring the System and Peripheral Clocks in the MC9S08GB/GT*.

4.8.1 Application Complete

The program will operate in exactly the same manner as in the previous section. The only noticeable difference will be the frequency of LED5 (buzzer in the case of the evaluation board), as the bus speed of the device has been set to the maximum using the on-board crystals.

5 HCS08 CodeWarrior Development Tools

5.1 CodeWarrior

5.2 Additional HC(S)08 Help Included with CodeWarrior

After CodeWarrior has been installed, assuming a “typical” or a “full” installation was performed), there will be some HC(S)08 specific documentation that will assist in fine-tuning your application.

The default location of CodeWarrior is:

- C:\Program Files\Freescale\CodeWarrior for HC08 V5.1

Directories and files of interest:

- Release_Notes\HC08\CW_Tools\HC08
 - This directory contains release notes for various sections of CodeWarrior, for example, linker, compiler, etc.
- CodeWarrior Help
 - This directory contains the generic CodeWarrior and is target independent.
- CodeWarrior Manuals
 - In this directory, the documentation is available as either on-screen help or standalone pdfs and are held within the relevant sub-directories.
 - hc08_manuals.pdf
 - HC08_Processor_Expert_User_Guide.pdf
 - Manual_Assembler_HC08.pdf
 - Manual_Compiler_HC08.pdf
 - Manual_Engine_HC08.pdf
 - Manual_ICD_HCS08.pdf
 - Manual_Mon08.pdf
 - Manual_True-Time_Simulator_HC08.pdf

5.3 Freescale

Freescale produces an integrated development environment (IDE) for the HC08 and HCS08. To obtain the best from the HCS08, the latest version should be used. The HC08 version will generate code that will work on an HC08, but it will not use any of the additional addressing modes on a couple of instructions; this can have a significant impact on both code size and performance.

Freescale offers a free version of the HCS08 IDE, which is initially limited to 1K of code generated from C. Upon registering the compiler, a license will be provided which will allow the compiler to generate up to 4K of code.

Freescale has other licenses which will allow 32K or 64K of code, upon payment of the relevant license fee.

5.4 CodeWarrior for HC(S)08

CodeWarrior is an integrated development environment that provides a graphical user interface (GUI) to code development. Code is developed as a project where all the files, configuration information, and debugging information (for example, hardware) required to generate/debug a program are stored.

CodeWarrior includes a project manager (Project window) which lists all the files required to compile the code and invoke the various development activities such as editing, compiling, or running and debugging the application using the simulator or actual hardware.

5.4.1 What's on the CD

Opening the CD in Windows Explorer will result in something like the following:

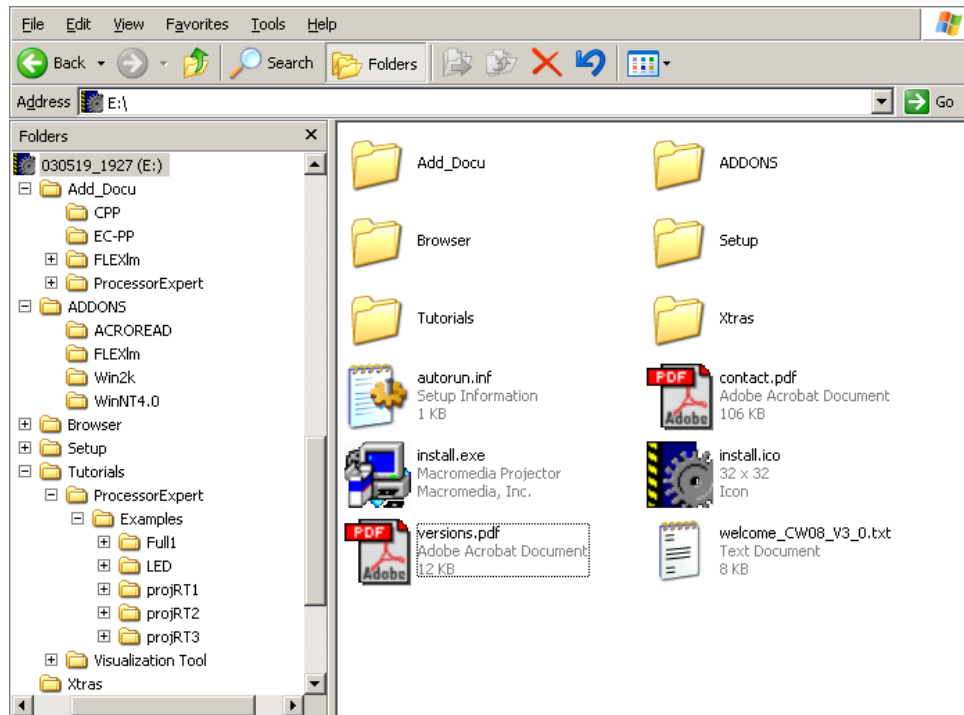

5.4.2 System Requirements for CodeWarrior

CodeWarrior is compatible with the following Microsoft products.

- Windows 98 (including SE)
- Windows ME
- Windows XP
- Windows NT 4
- Windows 2000

NOTE

Some versions of Windows may require installation of appropriate patches or service packs.

There may be additional restrictions on supported operating systems, due to debugging support; for example, USB Multilink requires Windows 2000 or XP, and is not supported with other versions of Windows.

5.4.3 Installing CodeWarrior

On inserting the CD into a Windows PC, the CodeWarrior installer will normally start automatically. (If this is not the case, locate the `install.exe` file on the CD and invoke it). Follow the on-screen instructions and refer to the booklet supplied with the CD for more help. (For the web download version, a “quick start” document is available on the web.)

5.4.4 CodeWarrior License

By default, CodeWarrior installs a code size limited version which is limited to generating runnable code of up to 1K byte in size. By registering, you can obtain a license file from Freescale by E-mail that will remove the code size limit on the assembler and linker; the C compiler code generator limit will be increased from 1K to 4K. (Registration is free; a valid E-mail address is required in order to send the license details.)

A 30-day evaluation license to the Standard or Professional Edition with an unlimited code size can be requested during the registration process; refer to the welcome text file included on the CD for details of how to request this.

NOTE

A registered version of CodeWarrior will have a 4K code size limit for C and an unlimited code size assembler.

5.4.5 CodeWarrior Updates

The boards and devices supported by CodeWarrior will be those available when released. There may be patches available for CodeWarrior to support newer boards and/or devices; check Freescale web support if the board or device is not supported by your version of CodeWarrior.

5.4.6 CodeWarrior “projects”

A “project” is simply a file (for example, M68DEMO908GB60_Demo1.mcp) that contains all the information required to compile and debug an application. Information in the project file typically includes:

- Directory location for sources, binaries, and other files
- Compiler settings for each source file
- Debugging details

CodeWarrior normally places the files within the directory of the project file or subdirectories; for example:

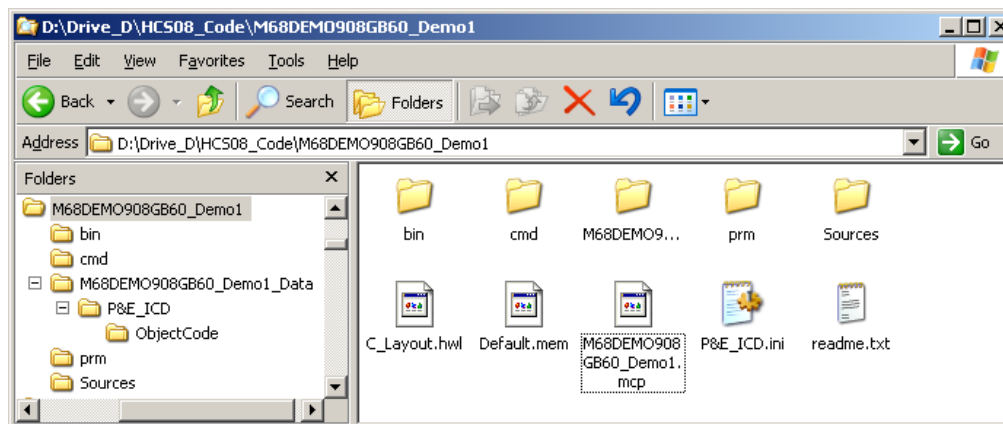

6 CodeWarrior C and HCS08

This section explains how the HCS08 devices are defined within CodeWarrior C, and how they are used.

In order to be able to write C code, for HCS08 devices, that utilizes the hardware, it is necessary to define the registers of the modules and their absolute addresses. CodeWarrior contains the register definitions and address space mapping for each device within two files: the device header file and the device definition file.

The device header file (MC9S08GB60.h) contains data declarations and definitions used to reference the device registers. Registers are allocated and mapped into the device's address space in the device definition file (MC9S08GB60.c), using the definitions from the header file.

A program normally consists of the device definition/mapping file (MC9S08GB60.c), the user code (for example, main.c), and a startup file (startup.c), which initializes the runtime environment. The startup code, device and header files are normally included automatically within the project by the "CodeWarrior project wizard", along with a default main program (main.c).

To access peripherals in a device, ensure that the device declaration file (MC9S08GB60.h) is included within the source file; for example:

```
#include <MC9S08GB60.h>

int mycode(){
}
```

6.1 Data Types

CodeWarrior C for the HCS08 supports all the normal C types. Also, the types byte (1 byte), word (2 bytes), dword (4 bytes), and dlong (8 bytes) are defined unsigned as follows:

```
/* Types definition */
typedef unsigned char byte;
typedef unsigned int word;
typedef unsigned long dword;
typedef unsigned long dlong[2];
```

6.2 What a Project Consists of

A newly created project looks like:

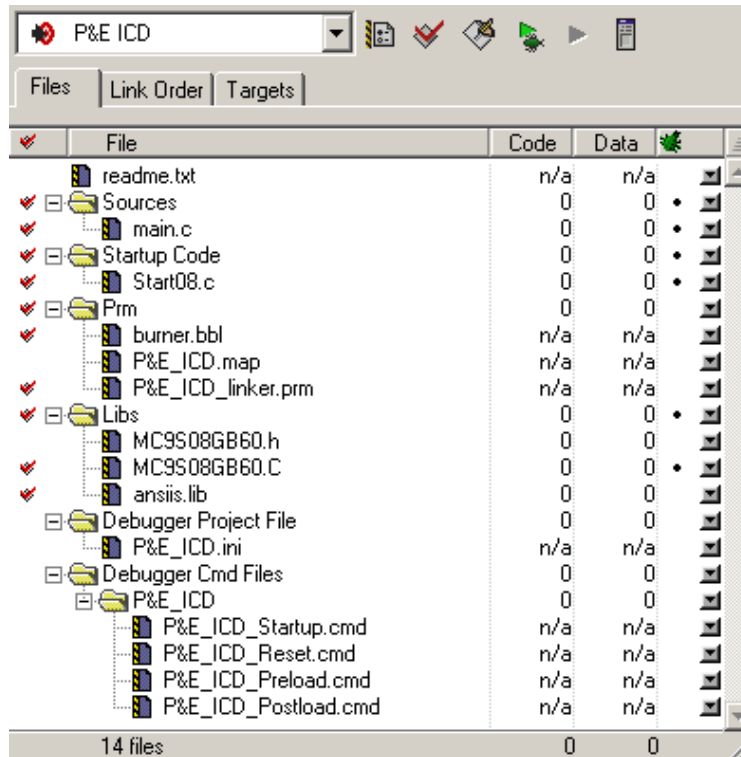

with the following files and directories created automatically:

- readme.txt
 - Initially contains a brief overview of the project structure, details of on-line help, and how to contact Freescale
- Sources/
 - Contains the users source code, sample main.c provided by wizard with project creation
- Startup Code/
 - Start.c - C/C++ startup code which initializes the C library and invokes the user code (main function)
- Prm/
 - burner.bbl - details of how to generate the required S-Record for the debugger
 - *.prm - details of how to link code/data segments
 - *.map - generated by the linker
- Libs/
 - Required library files (ANSI library)
 - Device header and device file
- Debugger Project File/
 - Contains an *.ini file for the debugger — essentially a project file for the debugger
- Debugger Cmd Files/
 - Contains sub-folders for each target connection method, along with command files

6.3 Using CodeWarrior Device Definitions

This section describes the method used by CodeWarrior in defining device registers, the mapping of these registers to memory, and how to use this information within a program.

All examples within this section refer to the MC9S08GB60. Substitute the appropriate device as required.

The names given to the device registers and bit names within the registers are defined by the device definition files. The two files associated with the MC9S08GB60 are:

- MC9S08GB60.c <- device file
- MC9S08GB60.h <- device definition/mapping file

To fully understand programming a particular device, it is essential to have the correct data sheet for the device, for example, the MC9S08GB60 Data Sheet (MC9S08GB60/D).

6.4 Device file (MC9S08GB60.c)

This file defines ALL registers within the device. All registers are named as per the register names in the relevant data sheet:

```
volatile <register>STR _<register>;
```

Where <register> is the name (in capital letters) of the register, as defined in the relevant data book (for example, MC9S08GB/D). All registers are defined as structure types, where the structure name is the same as the register name with STR appended. For example:

```
volatile KBI1PESTR _KBI1PE;
```

KBI1PE is the actual register. The structures are defined in the header file.

NOTE

For simplicity, the following examples will use the macro definitions of the registers.

6.5 Header File (MC9S08GB60.h)

This file makes available the register definitions for any file that requires access to the registers. It also maps the registers into the device's memory map.

The header file contains macros that allow the register to be referenced without the underscore. For example:

```
#define KBI1PE _KBI1PE
```

All registers can be referred to by their real definition, in this case “_KBI1PE” or via a macro, in this case “KBI1PE”.

6.6 Register and Bit Definitions

The header files supplied with CodeWarrior facilitate access to register bits through structures and do not include mask-based access to the register bits.

The following example shows the definition of the DBGCR register utilizing a structure.

```

/** DBGC - Debug Control Register */
typedef union {
    byte Byte;
    struct {
        byte RWBEN    :1;    /* Enable R/W for Comparator B */
        byte RWB      :1;    /* R/W Comparison Value for Comparator B */
        byte RWAEN    :1;    /* Enable R/W for Comparator A */
        byte RWA      :1;    /* R/W Comparison Value for Comparator A */
        byte BRKEN    :1;    /* Break Enable */
        byte TAG      :1;    /* Tag/Force Select */
        byte ARM      :1;    /* Arm Control */
        byte DBGREN   :1;    /* Debug Module Enable */
    } Bits;
} DBGCR;
extern volatile DBGCR _DBGCR @0x00001816;

```

The “:1” is used to indicate that a single bit is required and CodeWarrior C compiler will pack together into a single byte.

To access RWB would require the following code.

```

DBGCR.Bits.RWB = 1;    /*Set RWB bit of DBGCR */
DBGCR.Bits.RWB = 0;    /*Clear RWB bit of DBGCR */

```

To access RWB using the CodeWarrior predefined macros would require the following code.

```

DBGCR_RWB = 1;    /*Set RWB bit of DBGCR */
DBGCR_RWB = 0;    /*Clear RWB bit of DBGCR */

```

The CodeWarrior C Compiler will generate bit set/clear instructions for page 0 registers and memory; otherwise, it will generate bit mask operations (|=, &=) for other addresses. Using bit structures with HCS08 for I/O registers residing in page 0 is very efficient, requiring a single instruction for set, clear and test/branch.

6.7 How Device Registers and Bits are Used

To use a register, simply use its name as defined within the data sheet; for example:

- TPM2C0SC

To reference a bit within a register, concatenate the register name and the bit name with an underscore between. For example:

- TPM2C0SC_MS0B

NOTE

Register and bit names **MUST** be in capital letters.

6.8 How Device Registers are Defined and Used

In order to be able to program a device, it is necessary to understand the relationship between the device definition/mapping file and the device header file, and the register definitions contained within these files.

For example, the register TPM2C0SC:

```

main.c
Path: D:\Drive_D\HCS08_Code\M68DEM0908GB60_Demo1\Sources\main.c

TPM2C0SC = 2;
    
```

As a letter “O” was typed instead of a zero, the variable is undefined and so appears in black lettering.

After correcting, the register name appears in light blue:

```

main.c
Path: D:\Drive_D\HCS08_Code\M68DEM0908GB60_Demo1\Sources\main.c

TPM2C0SC = 2;
    
```

To determine the definition of the variable TPM2C0SC, place the cursor over the variable name and right-click the mouse. A popup will appear, which will include an option to go to the variable declaration “Go to macro declaration of TPM2C0SC”:

```

main.c
Path: D:\Drive_D\HCS08_Code\M68DEM0908GB60_Demo1\Sources\main.c

TPM2C0SC = 2;
    
```

- Undo Typing
- Find and Open File...
- Go to macro declaration of TPM2C0SC**
- Compile
- Preprocess
- Disassemble
- Set Breakpoint

This will bring up a window showing the section of code that defines the variable:

```

extern volatile TPM2C0SCSTR _TPM2C0SC @0x00000065;
#define TPM2C0SC _TPM2C0SC.Byte
#define TPM2C0SC_ELS0A _TPM2C0SC.Bits.ELS0A
#define TPM2C0SC_ELS0B _TPM2C0SC.Bits.ELS0B
#define TPM2C0SC_MS0A _TPM2C0SC.Bits.MS0A
#define TPM2C0SC_MS0B _TPM2C0SC.Bits.MS0B
#define TPM2C0SC_CH0IE _TPM2C0SC.Bits.CH0IE
#define TPM2C0SC_CH0F _TPM2C0SC.Bits.CH0F
    
```

As can be seen in the example above, the variable is actually a macro definition to a structure element “Byte” of the variable _TPM2C0SC. The variable _TPM2C0SC is, in fact, defined as being a structure of type TPMC0SCSTR and at absolute address \$0065, as shown in the figure above. The definition of structure TPMC0SCSTR is:

```

/** TPM2C0SC - TPM 2 Timer Channel 0 Status and Control Register */
typedef union {
    byte Byte;
    struct {
        byte          :1;
        byte          :1;
        byte ELS0A    :1;
        byte ELS0B    :1;
        byte MS0A     :1;
        byte MS0B     :1;
        byte CH0IE    :1;
        byte CH0F     :1;
    } Bits;
} TPM2C0SCSTR;
    
```

Summary: From the example of TPM2C0SC, it can be seen that the way registers are defined within CodeWarrior is:

A register, as defined in a data sheet (for example, TPM2C0SC), is a macro that refers to a byte within a structure, and is mapped to the relevant address for the device in question.

CodeWarrior header files for HCS08 use bit structures as opposed to masks. All code will utilize the CodeWarrior structures.

6.9 How Device Register Bit(s) are Defined / Used

The method used for defining register bits follows a similar method as used for the actual registers, except that, in the case of register bits, it is necessary to specify both the register name and the bit name as defined in the data sheet, for example, MS0B and TPM2C0SC both need to be specified. The way in which the bit name and register name are used is to concatenate their names together with an underscore between; for example:

- TPM2C0SC_MS0B

The definition of the bit can be found by right-clicking on the appropriate variables. For example:

```

MC9S08GB60.h
Path: C:\Program Files\Metrowerks\Cod...MC9S08GB60.h
#define TPM2C0SC_MS0B _TPM2C0SC.Bits.MS0B
Line 2547 Col 1
    
```

The definition of _TPM2C0SC:

```

MC9S08GB60.c
Path: C:\Program Files\Metrowerks\CodeWarrior\CW08_V3.0\lib\HCS08c\SRC\MC9S08GB60.c
volatile TPM2C0SCSTR _TPM2C0SC; /* TPM 2 Timer Channel 0 Status and Control Register */
Line 156 Col 1
    
```

Definition of type TPM2C0SCSTR is a structure:

```

MC9S08GB60.h
Path: C:\Program Files\Metrowerks\CodeWarrior\CW08_V3.0\lib\HCS08c\INCLUDE\MC9S08GB60.h
/** TPM2C0SC - TPM 2 Timer Channel 0 Status and Control Register */
typedef union {
    byte Byte;
    struct {
        byte :1;
        byte :1;
        byte ELS0A :1; /* Edge/Level Select Bit A */
        byte ELS0B :1; /* Edge/Level Select Bit B */
        byte MS0A :1; /* Mode Select A for TPM Channel 0 */
        byte MS0B :1; /* Mode Select B for TPM Channel 0 */
        byte CH0IE :1; /* Channel 0 Interrupt Enable */
        byte CH0F :1; /* Channel 0 Flag */
    } Bits;
} TPM2C0SCSTR;
Line 2535 Col 34
    
```

Now MS0B is one bit of a byte in the structure Bits of the structure TPM2C0SCSTR, so we can use:

- `_TPM2C0SC.Bits.MS0B`

or

- `TPM2C0SC.Bits.MS0B`

To reference it, alternatively, we can use one of the predefined macros:

- `TPM2C0SC_MS0B`

Both examples refer to the Mode select B of TPM channel 0.

Summary: A register bit is defined by a macro as being its register and bit name concatenated together with an underscore between the register and bit names.

6.10 Register Names Used with Multiple Peripherals

Some devices have multiple peripherals; for example, the MC9S08GB60 has two SCIs. It may be necessary to check the naming of the peripherals in the device and header files but, in general, they should be defined as per the data sheet.

For example, the MC9S08GB60 has multiple timers (timer 1 and timer 2), which have multiple channels (three on timer 1 and five on timer 2). As an example, the status channel for a channel is defined as:

```
TPMxCnSC
  CHnF - flag
  CHnIE - interrupt enable
  MSnB - mode select B
  MSnA - mode select A
  ELSnB:ELSnA - Edge/Level select bits
```

Where

```
x = the timer
n = the channel
```

Therefore, to reference the flag bit of channel 2 on timer 1, the macro defined in the header file is:

```
TPM1C2SC_CH2F
```

7 Frequently Asked Questions

This section identifies the main issues that a newcomer to CodeWarrior may experience, and explains how to proceed.

Where can I get the most up to date documentation?

The most up to date documentation for CodeWarrior is available on the Freescale web site.

Device and/or target isn't supported by CodeWarrior?

Check the Freescale web site for availability of patches to support device and/or target.

In the “Updates and Patches” section, select “CodeWarrior for Freescale HC08”, press “select”, and a list of available patches will appear. Download the appropriate patch and install (a reboot of the PC will be required).

USB BDM doesn't work with HC08 CodeWarrior v3.0?

CodeWarrior version 3.0 was shipped before P&E USB BDM was available. To add USB BDM functionality it is necessary to install a service pack. The service pack is available from the CodeWarrior web site.

Tips on using a parallel BDM pod?

General suggestions for successfully using a Multilink BDM connector.

- Upgrade to the latest version of CodeWarrior
- Ensure that the BDM pod is using the latest firmware (<http://www.pemicro.com>)
- Ensure that the parallel port BDM hardware is at the latest revision. With the exception of Rev.A, all Multilinks can be upgraded to latest spec (currently Rev.D) (<http://www.pemicro.com>)
- Ensure that the parallel port is configured as a standard port in computer's BIOS. The BIOS settings for the Parallel port should be SPP, Normal, Standard, Output Only, Unidirectional or AT. Try to avoid ECP, EPP or PS/2 Bidirectional
- Limit the BDM cable length between MultiLink and target
- Do not protect the FLASH during code development and debugging

P&E parallel Multilink BDM & laptop

Some laptops ship with a 3v parallel port and may not work reliably with the P&E parallel Multilink BDM. To overcome this the Multilink should be powered by an external 5v supply. Connect an external 5v center negative power supply to the optional power jack of the P&E Multilink BDM.

Monitor mode is not working?

There are several ways this can occur:

- Monitor erased
 - reprogram
- Clock speed is incorrectly assumed within monitor
 - reprogram device with different clock setup
 - change crystal to 32.768 kHz or 4 MHz, according to version of monitor in device

Other than changing the crystal, a BDM will be required to reprogram the monitor code or alter the device's clock frequency used by the monitor.

How do I reprogram the HCS08 monitor?

If the HCS08 monitor is erased or corrupted, it will be necessary to download the HCS08 monitor code to the device utilizing a BDM; there is no other way.

Refer to application note AN2140/D — *Serial Monitor for MC9S08GB/GT* for a description of the monitor and the CodeWarrior project files required for re-programming the monitor.

How can I program small batches of HCS08 devices without tying up a PC?

An HCS08 can be programmed only using the serial monitor mode or BDM. P&E make a BDM pod that can be connected to the PC via usb, parallel or ethernet, which can also be used as a standalone programmer. Refer to P&E's web site for product details and ordering information on the CYCLONE PRO

http://www.pemicro.com/products/product_viewDetails.cfm?product_id=1

Code in FLASH only works when BDM is powered?

Disconnect the BDM pod, as it is interfering with the devices normal operation.

Debugger not showing the source code of main.c?

To show the source code for main.c in the debugger, simply right-click over the source code window:

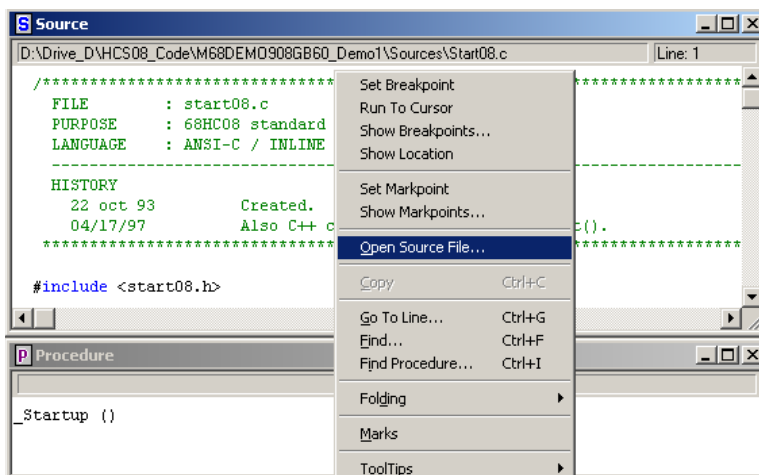

and select “Open Source File”. A dialog box will pop up, allowing selection of the correct source file (for example, main.c):

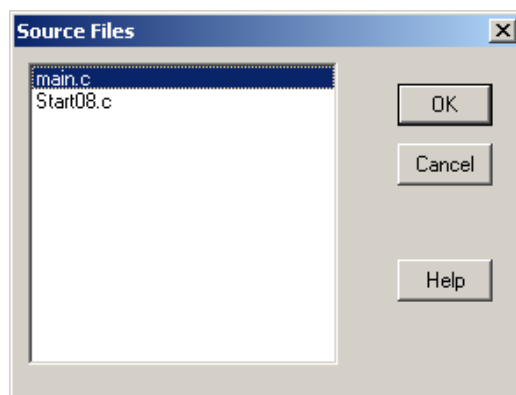

After selecting the correct file, the source window will appear:

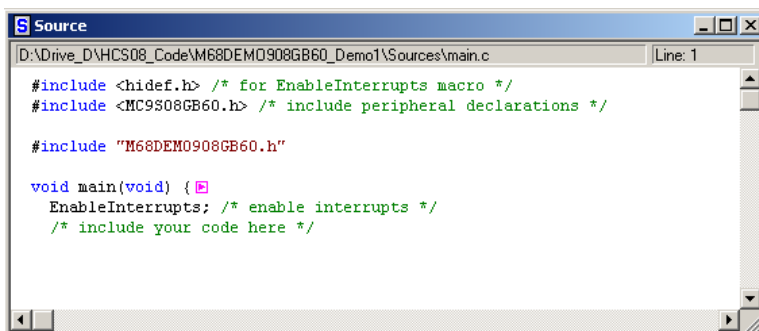

How do I set a breakpoint in the debugger?

To set a break point whilst in the debugger, select some text where the break point is required, or hold the mouse over the relevant code and press the right mouse button. A popup dialog box will appear; the first option is to set a break point:

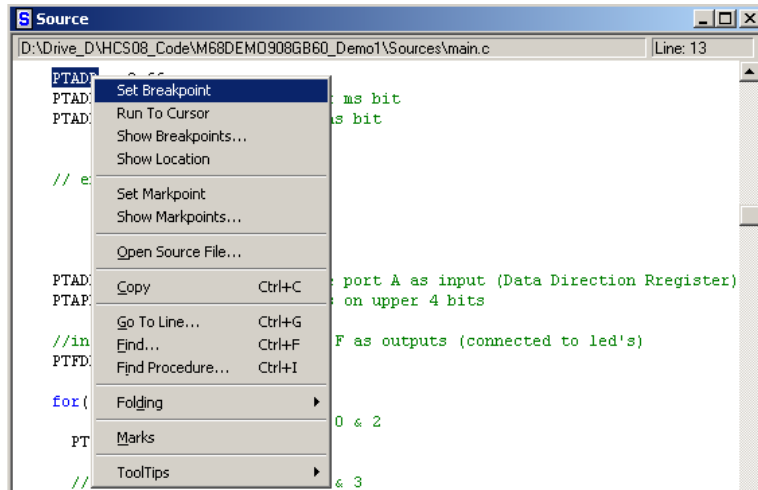

The break point will be shown in the source window with a red arrow:

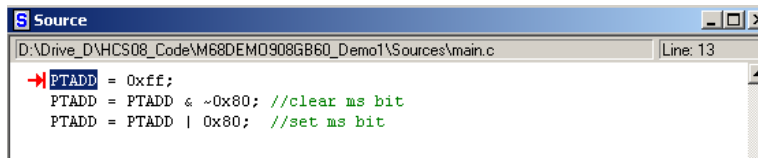

To remove a breakpoint, simply select (or place the mouse over) the break point you wish to remove and right click the mouse.

A popup dialog will appear, the first option being to delete the break point:

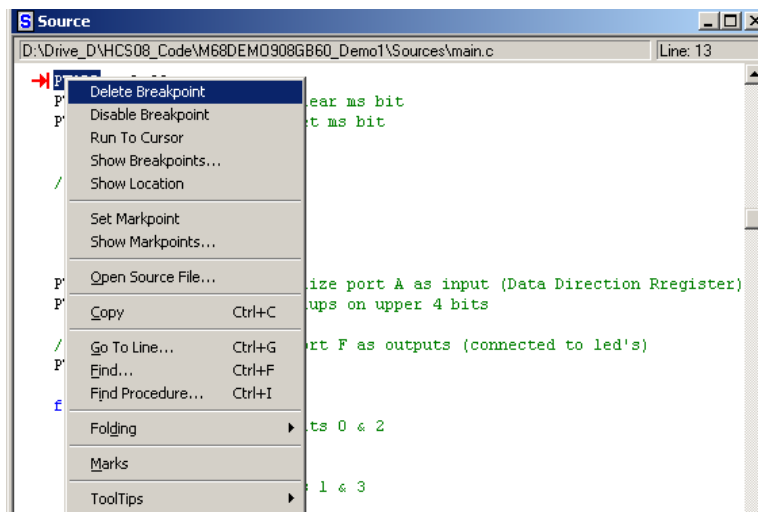

Debugging does not seem to use the hardware/select in-circuit debug

The most likely reason for this is that the debugger is using the simulator or the wrong hardware. A may be caused by the debugger not finding a BDM pod when it started and it defaulted to the software simulator.

Ensure the correct target is set.

To set in-circuit debug/programming whilst in “Full Chip Simulation” mode, select “In-Circuit Debug/Programming” via the PEDebug pull-down menu:

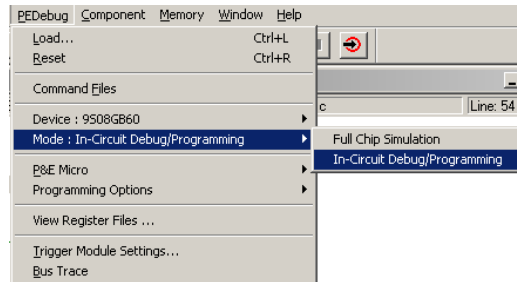

The debugger will revert to the stage after it was invoked from the project manager and should erase and reprogram the device.

How can I see the assembler code generated for C statements?

When reviewing C code in order to optimize, it is helpful to see exactly what code is generated by the compiler for a C statement. The easiest way to do this is to highlight the relevant C code:

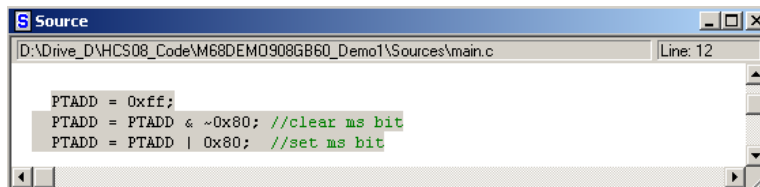

Next, drag the C code to the assembler window (hold the mouse down over the selected text, move the cursor over the assembler window, and release) and the assembly language statements for the C code will be highlighted:

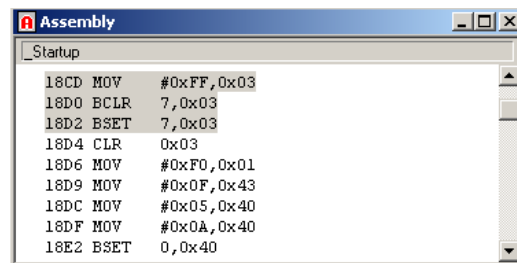

NOTE

Due to the optimization performed by the compiler, some code may not be highlighted.

What are all the interrupt vector numbers for the MC9S08GB60?

The following define statements include ALL the interrupt vectors of the MC9S08GB60.

```
#define VNreset      0
#define VNswi       1
#define VNirq       2
#define VNlvd       3
#define VNicg       4
#define VNtpm1ch0   5
#define VNtpm1ch1   6
#define VNtpm1ch2   7
#define VNtpm1ovf   8
#define VNtpm2ch0   9
#define VNtpm2ch1  10
#define VNtpm2ch2  11
#define VNtpm2ch3  12
#define VNtpm2ch4  13
#define VNtpm2ovf  14
#define VNspi       15
#define VNscilerr   16
#define VNscilrx    17
#define VNsciltx    18
#define VNsci2err   19
#define VNsci2rx    20
#define VNsci2tx    21
#define VNkeyboard  22
#define VNatd       23
#define VNiic       24
#define VNrti       25
```

Where are header files located?

Basically, there are two types of header files used within C:

- System - placed within angled brackets (< and >)
- User - placed within double quotes ("")

System header files are located within the CodeWarrior directories; for the HCS08, they are located in the directory "CodeWarrior for HC08 V5.1\lib\hc08c\include".

User header files are normally located within a sub-directory of the project directory (for example, Sources or headers). User headers are made available to the user by adding them to the project.

Should I use bit fields or masks for bit manipulation?

CodeWarrior will use bit field instructions (bit set, clear, test/branch) for bit field data or simple mask operations on data within page 0.

For memory other than page 0, the compiler translates bit field operations to bit mask operations.

How does the compiler use page 0?

Most registers are defined within page 0, and the compiler will utilize direct addressing wherever possible when using the peripheral registers. The linker files generated for a device do not use page 0 by default (unless the device only has RAM in page 0). The default will allocate variables in extended memory.

How can I force a variable to reside in page 0?

To instruct the linker to allocate storage for variables in page 0, enclose the declarations within the following #pragma statements in the file where the variable is declared (for example, main.c):

```
#pragma DATA_SEG __SHORT_SEG MY_ZEROPAGE
/*Page 0 data declarations go here*/
#pragma DATA_SEG DEFAULT
```

For example:

```
#pragma DATA_SEG __SHORT_SEG MY_ZEROPAGE
byte p0i, p0j;
#pragma DATA_SEG DEFAULT
```

The first #pragma statement instructs the compiler to allocate data from this point on in the short segment (page 0), MY_ZEROPAGE is the default data segment used within the linker file.

The second #pragma statement instructs the compiler to return to the default data section for allocation of subsequent variables.

NOTE

Segment names assume default project and linker configuration used.

How do I disable the watchdog?

It may be necessary to disable the watchdog whilst debugging code, or an application may not require it.

To disable the watchdog, simply clear the COPE bit in the SOPT register as follows:

```
SOPT_COPE = 0;
```

Problems with variable, structure, or type definition?

Occasionally, CodeWarrior will not have the correct definition for a variable, a structure type or a macro definition, for example. This may be due to CodeWarrior’s cached definition; it can normally be rectified by clearing all object code from a project and rebuilding:

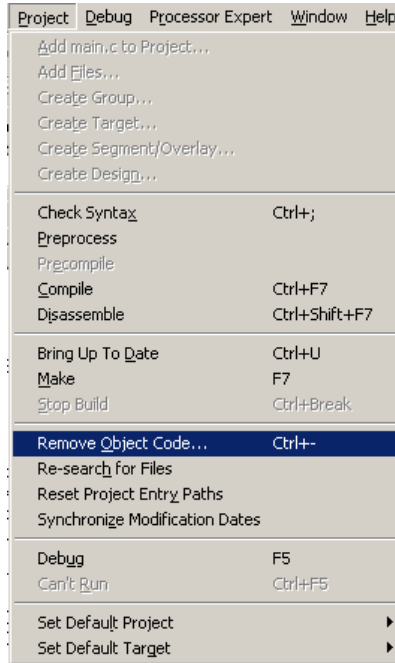

How do I add interrupt handlers?

CodeWarrior supports a number of ways of incorporating interrupts, the most common methods being

- Use a #pragma TRAP_PROC prior to the interrupt routine and add to the vector table in the linker.prm file. For example:

```
#pragma TRAP_PROC
void intSW1(void){
}
```

or

- Use the keyword “interrupt” and add to the vector table in the linker.prm file. For example:

```
interrupt void intSW1(void){
}
```

and:

- Add the vector table entry to the linker.prm file. For example:

```
VECTOR ADDRESS 0xFFD2 intSW1
```

Frequently Asked Questions

- Use the keyword “interrupt” and specify the interrupt vector number in the definition of the interrupt routine. This does not require any modification to the linker.prm file. For example:

```
interrupt 22 void intSW1(void){
}
```

This method has the advantage of defining an interrupt handler and its vector in a single file, removing the need to maintain two files.

How can I use the assembler within C?

Refer to section “High Level Online Assembler for Freescale HC08” in the document *Manual_Compiler_HC08.pdf* included with CodeWarrior.

How are interrupt vectors redirected?

The serial monitor implements a redirection of the vector table in an unprotected area of FLASH; this is discussed in the HCS08 serial monitor documentation.

How do I use masks?

A mask-based definition for a register would look something like:

```
/** DBGC - Debug Control Register */
extern volatile byte _DBGC @0x00001816;
#define RWBEN 0x01; /* Enable R/W for Comparator B */
#define RWB 0x02; /* R/W Comparison Value for Comparator B */
#define RWAEN 0x04; /* Enable R/W for Comparator A */
#define RWA 0x08; /* R/W Comparison Value for Comparator A */
#define BRKEN 0x10; /* Break Enable */
#define TAG 0x20; /* Tag/Force Select */
#define ARM 0x40; /* Arm Control */
#define DBGEN 0x80; /* Debug Module Enable */
```

To access RWB would require the following code:

```
DBGC = DBGC | RWB; /*Set RWB bit of DBGC */
DBGC = DBGC & ~RWB; /*Clear RWB bit of DBGC */
```

NOTE

CodeWarrior header files implement structures, NOT bit masks. If you wish to use bit masks, they must be defined manually.

How do I set the compiler options?

In order to set compiler options, select “Settings” from the Edit menu:

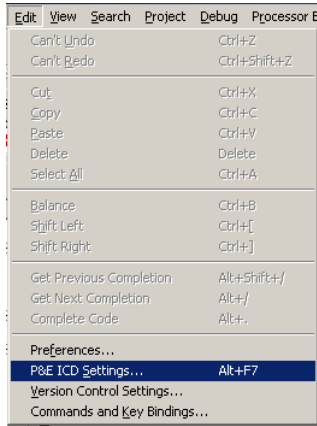

Or press the Settings button:

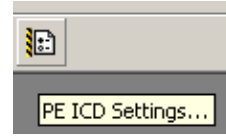

A dialog box will appear, allowing access to the compiler options, either by simply entering them as command line arguments:

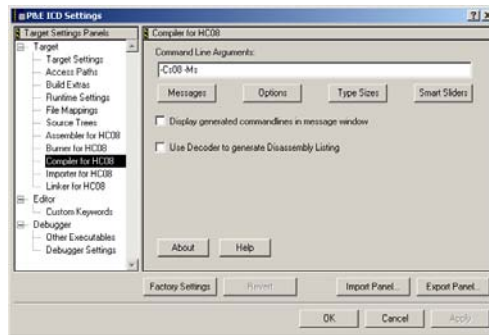

or by using one of the sub-option windows; for example, “Smart sliders”:

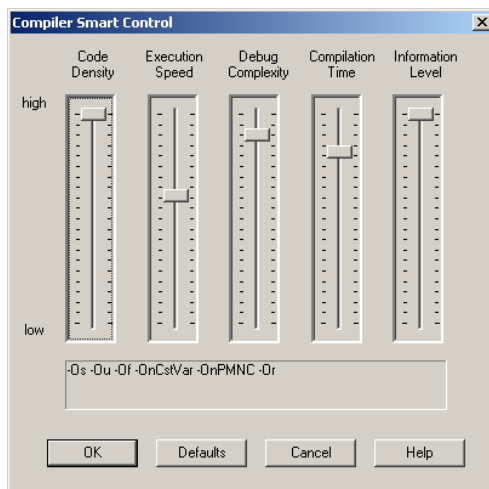

This provides a graphical front end to the selection of the compiler switches.

Big Endian or Little Endian?

The Endianness of a processor refers to the order in which it stores multiple byte values in memory. Big Endian processors store the most significant byte at the lowest address, whereas Little Endian processors store the least significant byte at the lowest address. This can cause issues if it is not taken into account.

For a more thorough discussion of Endianness refer to:

<http://www.wikipedia.org/wiki/Endianness>

The HCS08 (like all 68HCxx) is a Big Endian processor.

Endianness is also used to express the order of bits within a byte, and is typically used within serial communications. Serial communications may expect data least significant bit (Little Endian) or most significant bit (Big Endian) first. RS232 expects bits to be sent in Little Endian format. The SCI on an HCS08 transmits data in Little Endian format; the SPI on an HCS08 is selectable as Big Endian or Little Endian. An example of a Big Endian serial protocol is MIL-STD-1553B, where data transmissions are most significant bit first.

NOTE

If connecting external peripherals, check the Endianness to ensure compatibility.

Check Core and Compiler for Big Endianness?

The following piece of code checks the processor and compiler for Big Endianness.

First, create a union/structure to allow word or byte access to a union/structure for a 16-bit integer:

```
// Declare union to access word as word or two bytes
typedef union {
    word w;
    struct {
        byte h;
        byte l;
    } bytes;
} TEMP;
```

Next, define required variables, one using the union/structure, an error counter, and a byte pointer:

```
TEMP t; //declare temporary variable using union
byte err; //error count
byte *p; //pointer to access bytes within word
```

Clear the error count, and set the word so that the upper and lower bytes are unique:

```
err=0; //clear error count
t.w = 0x55aa; //set word so high byte and low byte are different
```

Check using pointers to access the individual bytes of the word in the correct order:

```
p=(byte *)&t.w; //set pointer to address of word
if(t.bytes.h!=*p)err|=1; //should be pointing to the high byte
p++; //increment pointer to next byte
if(t.bytes.l!=*p)err|=2; //should be pointing to the low byte
```

Check that, using union/structure, access to the individual bytes of the word is correct:

```

if(t.bytes.h!=0x55)err|=4; //check high byte accessed as structure
if(t.bytes.l!=0xaa)err|=8; //check low byte accessed as structure
    
```

The results should be 0.

Is Linux/Unix support available?

Cosmic supports Linux, Solaris and HP/UX as well as supporting Windows:

Platform	Part No	Description
Linux	CLXH08	C Cross Compiler, Assembler, Linker and IDEA package targeting Freescale's 68HC08 microcontroller
SUN Solaris	CSSH08	C Cross Compiler, Assembler, Linker and IDEA package targeting Freescale's 68HC08 microcontroller
SUN Solaris	ZSSH08SIM	ZAP Debugger Simulator for 68HC08
HP-UX	CHPH08	C Cross Compiler, Assembler, Linker and IDEA package targeting Freescale's 68HC08 microcontroller
HP-UX	ZPH08SIM	ZAP Debugger Simulator for 68HC08

8 References

The following publications may be of interest. They are available on Freescale's web site at:

<http://www.freescale.com/>

- AN1752/D Data Structures for 8-Bit Microcontrollers
- AN1837/D Non-Volatile Memory Technology Overview
- AN2093/D Creating Efficient C Code for the MC68HC08
- AN2111/D A Coding Standard for HCS08 Assembly Language
- AN2140/D Serial Monitor for MC9S08GB/GT
- AN2342/D Opto Isolation Circuits For In Circuit Debugging of 68HC9(S)12 and 68HC908 Microcontrollers
- AN2438/D ADC Definitions and Specifications
- AN2493/D AN2493/D: MC9S08GB/GT Low Power Modes
- AN2494/D Configuring the System and Peripheral Clocks in the MC9S08GB/GT
- AN2496/D Calibrating the MC9S08GB/GT Internal Clock Generator (ICG)
- AN2497/D HCS08 Background Debug Mode versus HC08 Monitor Mode
- M68EVB908GB60 Development board for Freescale MC9S08GB60
- M68DEMO908GB60 Demonstration Board for Freescale MC9S08GB60
- MC9S08GB60/D MC9S08GB60, MC9S08GT60, MC9S08GB32, MC9S08GT32 Data Sheet
- HCS08RMv1/D HCS08 Family Reference Manual

FREESCALE SOFTWARE LICENSE AGREEMENT

This is a legal agreement between you (either as an individual or as an authorized representative of your employer) and Freescale, Inc. (“Freescale”). It concerns your rights to use this file and any accompanying written materials (the “Software”). In consideration for Freescale allowing you to access the Software, you are agreeing to be bound by the terms of this Agreement. If you do not agree to all of the terms of this Agreement, do not download the Software. If you change your mind later, stop using the Software and delete all copies of the Software in your possession or control. Any copies of the Software that you have already distributed, where permitted, and do not destroy will continue to be governed by this Agreement. Your prior use will also continue to be governed by this Agreement.

LICENSE GRANT. Freescale grants to you, free of charge, the non-exclusive, non-transferable right (1) to use the Software, (2) to reproduce the Software, (3) to prepare derivative works of the Software, (4) to distribute the Software and derivative works thereof in source (human-readable) form and object (machine-readable) form, and (5) to sublicense to others the right to use the distributed Software. If you violate any of the terms or restrictions of this Agreement, Freescale may immediately terminate this Agreement, and require that you stop using and delete all copies of the Software in your possession or control.

COPYRIGHT. The Software is licensed to you, not sold. Freescale owns the Software, and United States copyright laws and international treaty provisions protect the Software. Therefore, you must treat the Software like any other copyrighted material (for example, a book or musical recording). You may not use or copy the Software for any other purpose than what is described in this Agreement. Except as expressly provided herein, Freescale does not grant to you any express or implied rights under any Freescale or third party patents, copyrights, trademarks, or trade secrets. Additionally, you must reproduce and apply any copyright or other proprietary rights notices included on or embedded in the Software to any copies or derivative works made thereof, in whole or in part, if any.

SUPPORT. Freescale is NOT obligated to provide any support, upgrades or new releases of the Software. If you wish, you may contact Freescale and report problems and provide suggestions regarding the Software. Freescale has no obligation whatsoever to respond in any way to such a problem report or suggestion. Freescale may make changes to the Software at any time, without any obligation to notify or provide updated versions of the Software to you.

NO WARRANTY. TO THE MAXIMUM EXTENT PERMITTED BY LAW, FREESCALE EXPRESSLY DISCLAIMS ANY WARRANTY FOR THE SOFTWARE. THE SOFTWARE IS PROVIDED “AS IS”, WITHOUT WARRANTY OF ANY KIND, EITHER EXPRESS OR IMPLIED, INCLUDING, WITHOUT LIMITATION, THE IMPLIED WARRANTIES OF MERCHANTABILITY, FITNESS FOR A PARTICULAR PURPOSE, OR NON-INFRINGEMENT. YOU ASSUME THE ENTIRE RISK ARISING OUT OF THE USE OR PERFORMANCE OF THE SOFTWARE, OR ANY SYSTEMS YOU DESIGN USING THE SOFTWARE (IF ANY). NOTHING IN THIS AGREEMENT MAY BE CONSTRUED AS A WARRANTY OR REPRESENTATION BY FREESCALE THAT THE SOFTWARE OR ANY DERIVATIVE WORK DEVELOPED WITH OR INCORPORATING THE SOFTWARE WILL BE FREE FROM INFRINGEMENT OF THE INTELLECTUAL PROPERTY RIGHTS OF THIRD PARTIES.

INDEMNITY. You agree to fully defend and indemnify Freescale from any and all claims, liabilities, and costs (including reasonable attorney’s fees) related to (1) your use (including your sublicensee’s use, if permitted) of the Software or (2) your violation of the terms and conditions of this Agreement.

LIMITATION OF LIABILITY. IN NO EVENT WILL FREESCALE BE LIABLE, WHETHER IN CONTRACT, TORT, OR OTHERWISE, FOR ANY INCIDENTAL, SPECIAL, INDIRECT, CONSEQUENTIAL OR PUNITIVE DAMAGES, INCLUDING, BUT NOT LIMITED TO, DAMAGES FOR ANY LOSS OF USE, LOSS OF TIME, INCONVENIENCE, COMMERCIAL LOSS, OR LOST PROFITS, SAVINGS, OR REVENUES TO THE FULL EXTENT SUCH MAY BE DISCLAIMED BY LAW.

COMPLIANCE WITH LAWS; EXPORT RESTRICTIONS. You must use the Software in accordance with all applicable U.S. laws, regulations and statutes. You agree that neither you nor your licensees (if any) intend to or will, directly or indirectly, export or transmit the Software to any country in violation of U.S. export restrictions.

GOVERNMENT USE. Use of the Software and any corresponding documentation, if any, is provided with RESTRICTED RIGHTS. Use, duplication or disclosure by the Government is subject to restrictions as set forth in subparagraph (c)(1)(ii) of The Rights in Technical Data and Computer Software clause at DFARS 252.227-7013 or subparagraphs (c)(1) and (2) of the Commercial Computer Software--Restricted Rights at 48 CFR 52.227-19, as applicable. Manufacturer is Freescale, Inc., 6501 William Cannon Drive West, Austin, TX, 78735.

HIGH RISK ACTIVITIES. You acknowledge that the Software is not fault tolerant and is not designed, manufactured or intended by Freescale for incorporation into products intended for use or resale in on-line control equipment in hazardous, dangerous to life or potentially life-threatening environments requiring fail-safe performance, such as in the operation of nuclear facilities, aircraft navigation or communication systems, air traffic control, direct life support machines or weapons systems, in which the failure of products could lead directly to death, personal injury or severe physical or environmental damage ("High Risk Activities"). You specifically represent and warrant that you will not use the Software or any derivative work of the Software for High Risk Activities.

CHOICE OF LAW; VENUE; LIMITATIONS. You agree that the statutes and laws of the United States and the State of Texas, USA, without regard to conflicts of laws principles, will apply to all matters relating to this Agreement or the Software, and you agree that any litigation will be subject to the exclusive jurisdiction of the state or federal courts in Texas, USA. You agree that regardless of any statute or law to the contrary, any claim or cause of action arising out of or related to this Agreement or the Software must be filed within one (1) year after such claim or cause of action arose or be forever barred.

PRODUCT LABELING. You are not authorized to use any Freescale trademarks, brand names, or logos.

ENTIRE AGREEMENT. This Agreement constitutes the entire agreement between you and Freescale regarding the subject matter of this Agreement, and supersedes all prior communications, negotiations, understandings, agreements or representations, either written or oral, if any. This Agreement may only be amended in written form, executed by you and Freescale.

SEVERABILITY. If any provision of this Agreement is held for any reason to be invalid or unenforceable, then the remaining provisions of this Agreement will be unimpaired and, unless a modification or replacement of the invalid or unenforceable provision is further held to deprive you or Freescale of a material benefit, in which case the Agreement will immediately terminate, the invalid or unenforceable provision will be replaced with a provision that is valid and enforceable and that comes closest to the intention underlying the invalid or unenforceable provision.

NO WAIVER. The waiver by Freescale of any breach of any provision of this Agreement will not operate or be construed as a waiver of any other or a subsequent breach of the same or a different provision.

9 Trademarks

- Freescale and the Freescale logo are registered trademarks of Freescale, Inc.
- Microsoft, Windows, and Windows NT are registered trademarks of Microsoft Corporation in the U.S. and other countries.
- UNIX is a registered trademark of Open Group in the US and other countries.
- P&E is a trademark of P&E Microcomputer Systems, Inc.

How to Reach Us:

Home Page:
www.freescale.com

E-mail:
support@freescale.com

USA/Europe or Locations Not Listed:
Freescale Semiconductor
Technical Information Center, CH370
1300 N. Alma School Road
Chandler, Arizona 85224
+1-800-521-6274 or +1-480-768-2130
support@freescale.com

Europe, Middle East, and Africa:
Freescale Halbleiter Deutschland GmbH
Technical Information Center
Schatzbogen 7
81829 Muenchen, Germany
+44 1296 380 456 (English)
+46 8 52200080 (English)
+49 89 92103 559 (German)
+33 1 69 35 48 48 (French)
support@freescale.com

Japan:
Freescale Semiconductor Japan Ltd.
Headquarters
ARCO Tower 15F
1-8-1, Shimo-Meguro, Meguro-ku,
Tokyo 153-0064
Japan
0120 191014 or +81 3 5437 9125
support.japan@freescale.com

Asia/Pacific:
Freescale Semiconductor Hong Kong Ltd.
Technical Information Center
2 Dai King Street
Tai Po Industrial Estate
Tai Po, N.T., Hong Kong
+800 2666 8080
support.asia@freescale.com

For Literature Requests Only:
Freescale Semiconductor Literature Distribution Center
P.O. Box 5405
Denver, Colorado 80217
1-800-441-2447 or 303-675-2140
Fax: 303-675-2150
LDCForFreescaleSemiconductor@hibbertgroup.com

Information in this document is provided solely to enable system and software implementers to use Freescale Semiconductor products. There are no express or implied copyright licenses granted hereunder to design or fabricate any integrated circuits or integrated circuits based on the information in this document.

Freescale Semiconductor reserves the right to make changes without further notice to any products herein. Freescale Semiconductor makes no warranty, representation or guarantee regarding the suitability of its products for any particular purpose, nor does Freescale Semiconductor assume any liability arising out of the application or use of any product or circuit, and specifically disclaims any and all liability, including without limitation consequential or incidental damages. "Typical" parameters that may be provided in Freescale Semiconductor data sheets and/or specifications can and do vary in different applications and actual performance may vary over time. All operating parameters, including "Typicals", must be validated for each customer application by customer's technical experts. Freescale Semiconductor does not convey any license under its patent rights nor the rights of others. Freescale Semiconductor products are not designed, intended, or authorized for use as components in systems intended for surgical implant into the body, or other applications intended to support or sustain life, or for any other application in which the failure of the Freescale Semiconductor product could create a situation where personal injury or death may occur. Should Buyer purchase or use Freescale Semiconductor products for any such unintended or unauthorized application, Buyer shall indemnify and hold Freescale Semiconductor and its officers, employees, subsidiaries, affiliates, and distributors harmless against all claims, costs, damages, and expenses, and reasonable attorney fees arising out of, directly or indirectly, any claim of personal injury or death associated with such unintended or unauthorized use, even if such claim alleges that Freescale Semiconductor was negligent regarding the design or manufacture of the part.

Freescale™ and the Freescale logo are trademarks of Freescale Semiconductor, Inc. All other product or service names are the property of their respective owners.

© Freescale Semiconductor, Inc. 2006. All rights reserved.

RoHS-compliant and/or Pb-free versions of Freescale products have the functionality and electrical characteristics as their non-RoHS-compliant and/or non-Pb-free counterparts. For further information, see <http://www.freescale.com> or contact your Freescale sales representative.

For information on Freescale's Environmental Products program, go to <http://www.freescale.com/epp>.